

BEL2-A-02-NC
LED EYEBALL DOWNLIGHT

Catalog #		Prepared by	LiteHarbor
Project		Date	
Notes			



White



Black



LED DOWNLIGHT

2 Inch New Construction Round Shape LED Eyeball Downlight

Description

This is a 2" rotatable new construction LED eyeball downlight allow for you to set the ambiance in your space, a full range of repositioning to highlight your decoration, giving you everything needed to install this beautiful, ultra thin recessed lighting solution.

Features

- Aluminum housing with one piece frame constructed of high quality steel die cut.
- Swivel eyeball trim allows the flexibility focus light on a specific area and create the ambiance you desire.
- Protected LED driver performs at 120V.
- This fixture is built to last with maintenance-free energy efficient LEDs.
- Beam Angle: 30/60 Degree.
- IP Rating: IP44.

Applications

Apply to residential, automotive and parking, education, government, healthcare, hospitality, offices and banks, religious, retail.



Liteharbor Lighting Technology Co., Ltd.
 New Industry Area Hecun Danzao Town
 Nanhai Foshan City Guangdong China

TEL: +86-757-8180 8687
 FAX: +86-757-8180 8685
 E-mail: info@liteharbor.com

Website: www.liteharbor.com
 Specifications subject to change w/o notice
 Revision: May. 2019

Specification

Watt	6W
Voltage	AC 120V
Driver	Liteharbor
PF	>0.9
Dimming	Dimmable
Lumen	480lm
Light Source	COB
CRI	90+
Beam Angle	30D/60D
CCT	2700K-5000K
Material	Aluminum
Finish	White/Black

Listing / Warranty

ETL listed to US and Canadian standards for damp location W/Feed through.

3 Year Limited Warranty.

Dimensions

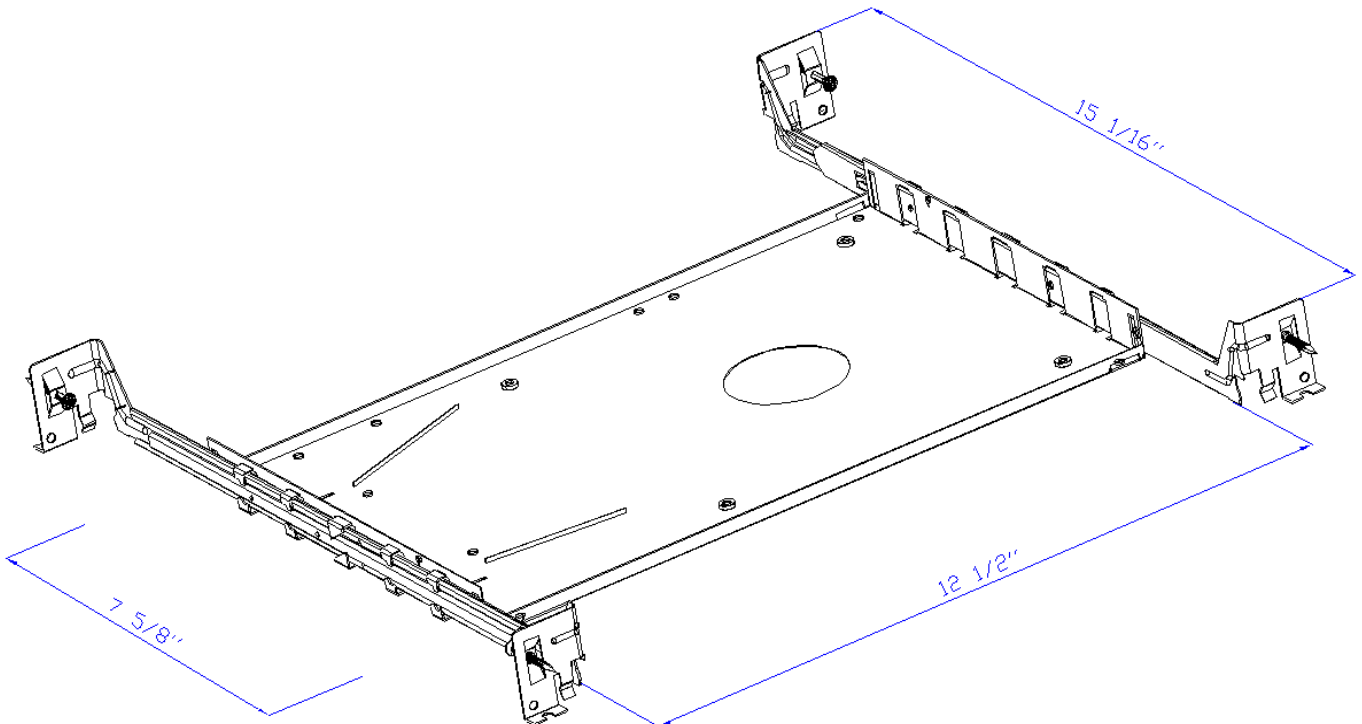

LED DOWNLIGHT



Liteharbor Lighting Technology Co., Ltd.

New Industry Area Hecun Danzao Town
Nanhai Foshan City Guangdong China

TEL: +86-757-8180 8687

FAX: +86-757-8180 8685

E-mail: info@liteharbor.com

Website: www.liteharbor.com

Specifications subject to change w/o notice

Revision: May. 2019

Structural Introduction

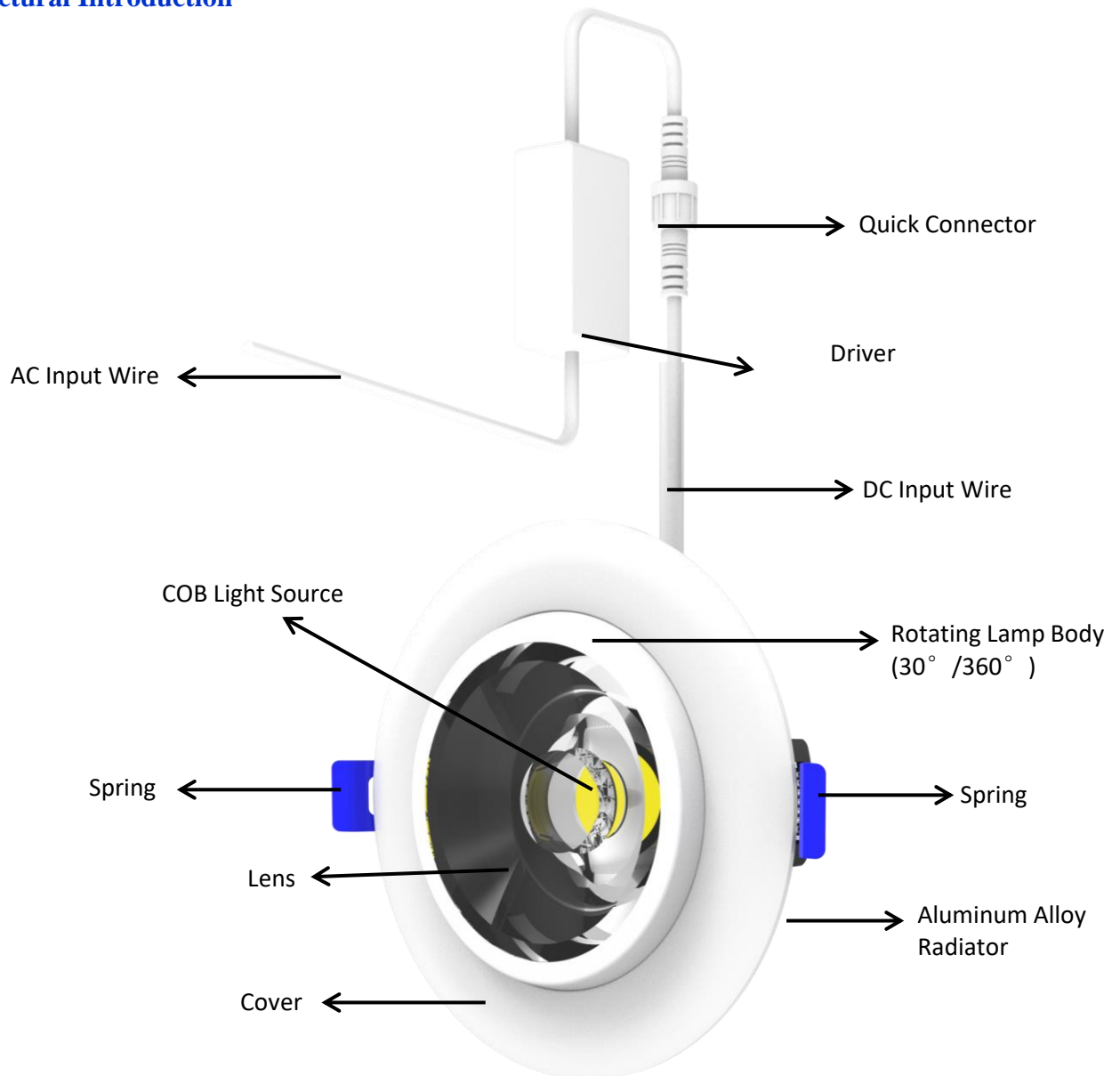

LED DOWNLIGHT

Ordering Guide

Series	Input Voltage	Watt	CCT	Finish
<input type="checkbox"/> BEL2-A-02-NC	<input type="checkbox"/> 120V	<input type="checkbox"/> 6W	<input type="checkbox"/> 2700K	<input type="checkbox"/> Black
LED Eyeball Downlight				
			<input type="checkbox"/> 3000K	<input type="checkbox"/> White
			<input type="checkbox"/> 4000K	
			<input type="checkbox"/> 5000K	



Liteharbor Lighting Technology Co., Ltd.
 New Industry Area Hecun Danzao Town
 Nanhai Foshan City Guangdong China

TEL: +86-757-8180 8687
 FAX: +86-757-8180 8685
 E-mail: info@liteharbor.com

Website: www.liteharbor.com
 Specifications subject to change w/o notice
 Revision: May. 2019