

# MR-024-2035 DIAMOND MIRROR

Catalog #		Prepared by LiteHarbor	
Project		Date	
Notes			



MR-024-2035







## FEATURES

- Wall mounted with L bracket and self adhesive pads.
- Approx 50,000 hour LED life.
- Built in anti-fogging with touch button on/off.
- Single touch button on the front, press once for backlight, press twice for Defogger, press 3 times for off.
- Easily Adjust Precisely To The Perfect Lighting With The Touch Dimmer.
- Pre Attached Hardware On Back Enables You The Option To Wall or Base Mount.
- Additional Safety Coating Produces A More Perfect Reflection, Prevents Oxidization & Prevents Glass From Scattering If The Mirror Is Broken.

## LISTING / WARRANTY

- cETLus listed for damp location and feed through wiring.
- 5 Year Limited Warranty.

## FUNCTION SELECTION

-  Product passed IP44 waterproof rated and it can be used in bathroom environment.
-  Fitted USB port for phone recharging.
-  Latest touching controls technology to turn the light on or off.
-  Multi style optional, shiny silver coated power outlet with USB port.
-  Heat the mirror to a few degrees above room temperature to keep the mirror from fogging.
-  Dimmable lighting lets you select the ideal brightness for any task.

## DESCRIPTION

- State-of-the-art, Exclusive bulbless design. The built-in long-lasting energy-efficient Daylight LED Modules. Glass undergoes a special process with a silver coated backing, resulting in a crystal clear reflection.
- The Latest In 5000k Daylight LED Modules, Spread Bright Even Lighting, all while reducing shadows.



MIRROR LIGHT



\*Other special requirements please contact with our sales.



**Liteharbor Lighting Technology Co., L**  
New Industry Area Hecun Danzao Town  
Nanhai Foshan City Guangdong China

TEL: +86-757-8180 8675  
FAX: +86-757-8180 8685  
E-mail: info@liteharbor.com

Website: www.liteharbor.com  
Specifications subject to change w/o notice  
Revision: Oct. 2021

## DIMENSIONS

H. mm W. mm D. mm

900x500x40 mm

\*Other sizes can be customized

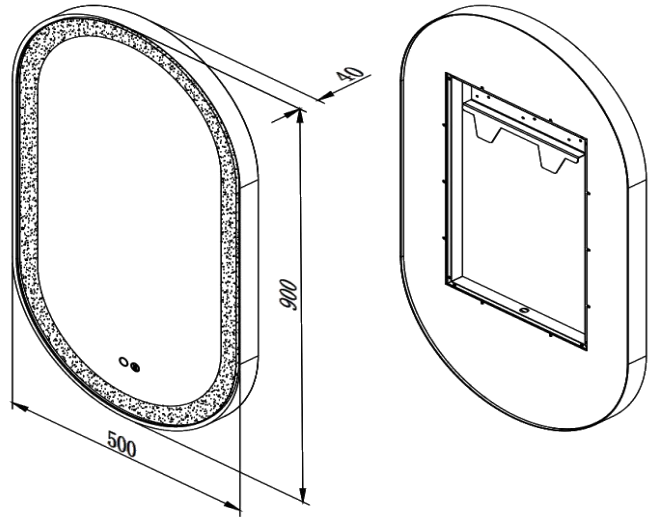

DETAILS			
Item No.	MR-024-2035	Original Lumens efficiency	100lm/w
Shape	Runway Shape	Light Source Type	INTEGRATED LED
IP Rating	IP44	Total Wattage	45W
Voltage	AC 120V-240V	Dimmable	Yes
Wattage	7W/ft	Location Rating	Damp Location
CRI	90	Total Lumen	4500lm
Function	Customization	Switch Type	Touch Switch
CCT	3000K/4000K/5000K	Sliver Mirror Thickness	5mm
Bluetooth speaker	Available	Listing	ETL listed



MIRROR LIGHT



\*Other special requirements please contact with our sales.



**Liteharbor Lighting Technology Co., L**

New Industry Area Hecun Danzao Town  
Nanhai Foshan City Guangdong China

TEL: +86-757-8180 8675

FAX: +86-757-8180 8685

E-mail: [info@liteharbor.com](mailto:info@liteharbor.com)

Website: [www.liteharbor.com](http://www.liteharbor.com)

Specifications subject to change w/o notice

Revision: Oct. 2021