

FJ-BL6-FM7-S FIRE RATED CEILING LIGHT

Catalog #		Prepared by	
Project		Date	
Notes			



PRODUCT SPECIFICATIONS – TRIM

An architecturally pleasing, easy to install and low profile slim LED instant mount round and square aperture downlighting. Slim line, light weight and sleek look, provides more A Series uniform light and an instant on. It is a low profile downlight intended for ceiling or wall mount applications. This luminaire offers the appearance of a recessed B Input Voltage downlight but is actually surface mounted.

LED LIGHT ENGINE

- LEDs mounted directly to heatsink designed to provide superior thermal management and ensure long life.
- 3 CCT range changeable, 3000K, 4000K and 5000K operated at reduced output for high efficacy and lumen maintenance.
- 2700K, 3000K, 3500K, and 4000K with 80+ CRI standard; other color temperatures and 90+ CRI available upon request.

LED DRIVER

- Choice of dedicated 120 volt (120) driver AC at 50/60Hz.
- Power factor > 0.9 at 120V input.
- 120 volt driver is dimmable with the use of most incandescent, magnetic low voltage and electronic low voltage wall box dimmers.
- External driver on 5" and 7" models only.
- For a list of compatible dimmers.



3 Year Limited Warranty



ETL Certificate



Damp Location



Airtight



IC Rated



2 hour fire rated

*Other special requirements please confirm with our factory.

2 HOURS FIRE RATED CEILING LIGHT

PRODUCT SPECIFICATIONS – HOUSING

- 2 Hour Fire Resistance to meet and exceed strict fire safety codes.
- Rated for direct contact with IC insulation.
- ETL Certificates ASTM E283 certified Air Tight.
- Die formed #16 gauge galvanized steel construction, Up to 120 minutes fire rated L500 (floor-ceiling) & P500 (roof-ceiling) design.

HANGER BARS

Pre-installed #21 gauge adjustable bar hangers (14"-24") for wood joist or t-bar ceiling installations.

APPLICATIONS

Slim LED Flush Mount Downlight is characterized by a completely flat lens with a narrow flange, giving it an architecturally pleasing look. This downlighting solution offers an affordable alternative to Air-Seal IC recessed housings or Fire-Rated boxes, reducing material and installation costs. Apply to automotive and parking, education, government, healthcare, hospitality, offices and banks, religious, retail. Especially in areas with limited ventilation, such as closets and utility rooms.

INSTALLATION

Pre Installed hanger bars with True Nail easy installation in regular lumber, engineered lumber, and Laminated Beams. Integral T-bar slots for easy installation in T-Bars. Spans up 24" and can be repositioned 90°. Score lines allow for tool-free hanger bar size reduction. Integral leveling flange allows for single-person installation while easily aligning the housings with the joists.

LISTING/WARRANTY

- ETL listed to US and Canadian standards for damp location W/Feed through. IC rated, Airtight ASTM-E283 Certified, UL 263 certificated up to 2 hour fire rated.
- 3 Year Limited Warranty.



Liteharbor Lighting Technology Co., Ltd.

New Industry Area Hecun Danzao Town
Nanhai Foshan City Guangdong China

TEL: +86-757-8180 8687

FAX: +86-757-8180 8685

E-mail: info@liteharbor.com

Website: www.liteharbor.com

Specifications subject to change w/o notice

Revision: Jun. 2022

DIMENSIONS

Unit:mm

Ceiling opening 96×96mm hole.

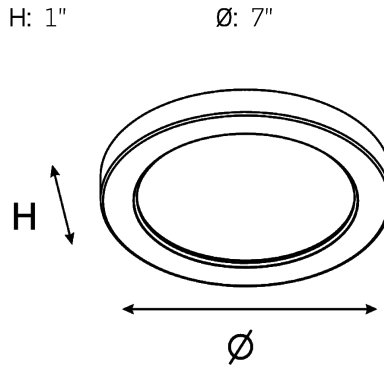
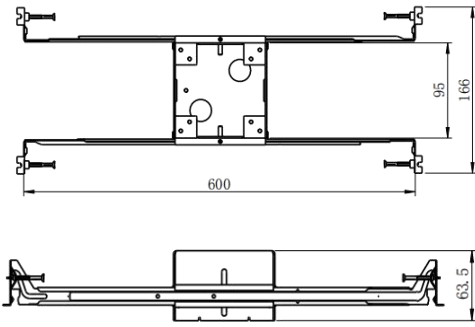

LIGHT ENGINE OPTION

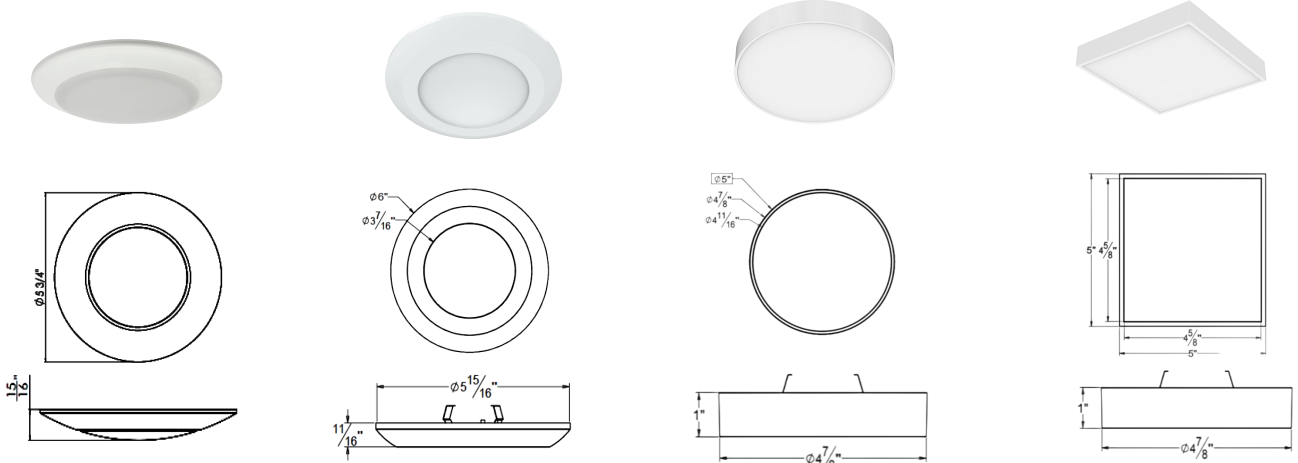

BL4-003

BL4-003-2

BL4-FM55-TL

BL4-SFM55-TL

Serise	BL4-003/BL6-003	BL4-003-2/BL6-003-2	BL4-FM55-TL/BL6-FM7-TL	BL4-SFM55-TL/BL6-SFM7-TL
Input Voltage	120V 60Hz AC	120V 60Hz AC	120V 60Hz AC	120V 60Hz AC
Color Temperature	3000K-6000K	3000K-6000K	3000K-6000K/3CCT	3000K-6000K/3CCT
Wattage	12W/14W	10W/15W	8W/10W/14W	8W/10W/14W
Dimmable	Triac Dimmable	Triac Dimmable	Triac Dimmable	Triac Dimmable
Lumen Output	850lm/1076 lm	550lm/900lm	550lm/720lm/1230lm	550lm/720lm/1230lm
CRI	80+/90+	80+/90+	80+/90+	80+/90+
LED Available	Cree/Citizen/Epistar	Cree/Citizen/Epistar	Cree/Citizen/Epistar	Cree/Citizen/Epistar
Finish	White/Black	White/Black	White/Black	White/Black
Applications	Dry /Damp locations	Dry /Damp locations	Dry /Damp locations	Dry /Damp locations

*Other special requirements please confirm with our factory.



Liteharbor Lighting Technology Co., Ltd.

New Industry Area Hecun Danzao Town
Nanhai Foshan City Guangdong China

TEL: +86-757-8180 8687

FAX: +86-757-8180 8685

E-mail: info@liteharbor.com

Website: www.liteharbor.com

Specifications subject to change w/o notice

Revision: Jun. 2022

PHOTOMETRICS

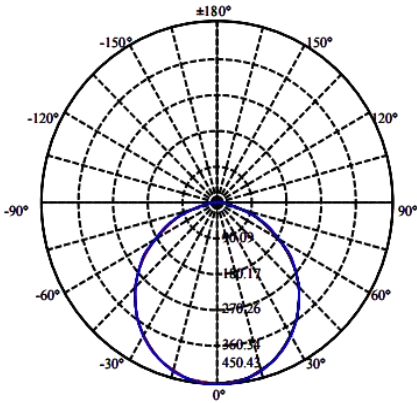

BL6-FM7-30K
 CCT:3000K LEDs
 input watts: 15W
 delivered lumens:1232.7, LM/W = 68.94
 test no. LCZP22060184
 tested in accordance to LC-I-902 GMS-2000

ZONAL LUMEN SUMMARY

Zone	Lumens	%Lamp	%Fixt
0-30	349.02	28.31%	28.31%
0-40	570.64	46.29%	46.29%
0-60	1000.86	81.19%	81.20%
0-90	1230.30	99.81%	99.81%
0-120	1231.06	99.87%	99.87%
0-180	1232.66	100.00%	100.00%
60-90	229.44	18.61%	18.61%
90-120	0.76	0.06%	0.06%
90-130	1.02	0.08%	0.08%
90-150	1.65	0.13%	0.13%
90-180	2.33	0.19%	0.19%
0-59.23	986.13	80.00%	80.00%

RHOC	80			70			50			30			10			0
RHOW	50	30	10	50	30	10	50	30	10	50	30	10	50	30	10	0
RCR	COEFFICIENTS OF UTILIZATION RHOPC=20 CU															
0	1.19	1.19	1.19	1.16	1.16	1.16	1.11	1.11	1.11	1.06	1.06	1.06	1.02	1.02	1.02	1.00
1	1.05	1.01	0.97	1.02	0.99	0.95	0.98	0.95	0.92	0.94	0.92	0.89	0.91	0.89	0.87	0.85
2	0.92	0.85	0.79	0.90	0.84	0.78	0.86	0.81	0.76	0.83	0.78	0.75	0.80	0.76	0.73	0.71
3	0.81	0.73	0.66	0.79	0.72	0.66	0.76	0.70	0.64	0.73	0.68	0.63	0.71	0.66	0.62	0.60
4	0.71	0.63	0.56	0.70	0.62	0.56	0.68	0.61	0.55	0.65	0.59	0.54	0.63	0.58	0.53	0.51
5	0.64	0.55	0.48	0.63	0.54	0.48	0.61	0.53	0.48	0.59	0.52	0.47	0.57	0.51	0.47	0.44
6	0.57	0.49	0.42	0.57	0.48	0.42	0.55	0.47	0.42	0.53	0.46	0.41	0.51	0.46	0.41	0.39
7	0.52	0.43	0.37	0.51	0.43	0.37	0.50	0.42	0.37	0.48	0.42	0.37	0.47	0.41	0.36	0.34
8	0.48	0.39	0.33	0.47	0.39	0.33	0.46	0.38	0.33	0.44	0.38	0.33	0.43	0.37	0.33	0.31
9	0.44	0.35	0.30	0.43	0.35	0.30	0.42	0.35	0.30	0.41	0.34	0.30	0.40	0.34	0.29	0.28
10	0.40	0.32	0.27	0.40	0.32	0.27	0.39	0.32	0.27	0.38	0.31	0.27	0.37	0.31	0.27	0.25

ORDERING GUIDE

Ceiling Light Series	Wattage	Input Voltage	Color Temperature
<input type="checkbox"/> FJ-BL4-FM55-S	<input type="checkbox"/> 10.5 10.5W	<input type="checkbox"/> 120 120V	<input type="checkbox"/> 30K 3000K
<input type="checkbox"/> FJ-BL4-SFM55-S	<input type="checkbox"/> 15 15W		<input type="checkbox"/> 40K 4000K
<input type="checkbox"/> FJ-BL6-FM7-S			<input type="checkbox"/> 50K 5000K
<input type="checkbox"/> FJ-BL6-SFM7-S			<input type="checkbox"/> 60K 6000K
			<input type="checkbox"/> 3CCT 3000K,4000K,5000K

Dimmable	Luminous Flux	Finish	CRI
<input type="checkbox"/> Triac Triac dimming	<input type="checkbox"/> 720lm	<input type="checkbox"/> WH White	<input type="checkbox"/> 80 80+
	<input type="checkbox"/> 1230lm	<input type="checkbox"/> BK Black	<input type="checkbox"/> 90 90+
		<input type="checkbox"/> SN Satin Nickel	

Light Source
<input type="checkbox"/> CREE
<input type="checkbox"/> Citizen
<input type="checkbox"/> Epistar
<input type="checkbox"/> Seoul
<input type="checkbox"/> Osram

*Other special requirements please confirm with our factory

 <p>Liteharbor Lighting Technology Co., Ltd. New Industry Area Hecun Danzao Town Nanhai Foshan City Guangdong China</p>	TEL: +86-757-8180 8687 FAX: +86-757-8180 8685 E-mail: info@liteharbor.com	Website: www.liteharbor.com Specifications subject to change w/o notice Revision: Jun. 2022

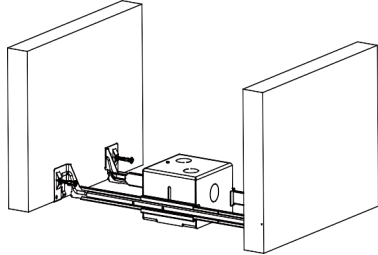
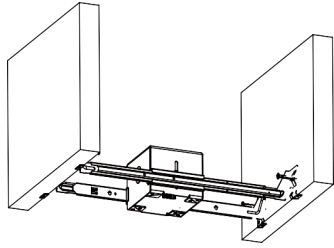
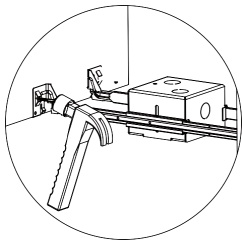
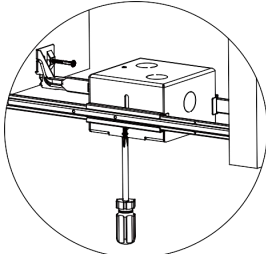
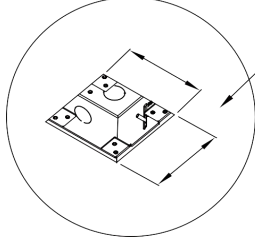

INSTALLATION INSTRUCTIONS

<p>Fire Rated Junction Box Installation Instruction</p>		
<p>1. Put the Junction Box to the Wood Joist Properly.</p>		
		 <p>Ceiling</p>
<p>2. Fix the Hanger Bar to Wood Joist with Rivet.</p>	<p>3. Moving the channels make the junction box to the properly place , then fix channel with screws.</p>	<p>4. Ceiling opening 96×96mm hole.</p>

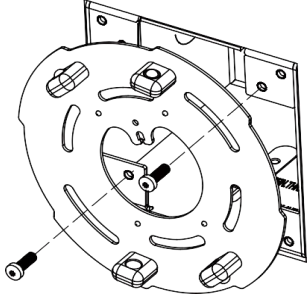
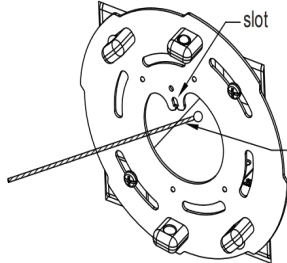
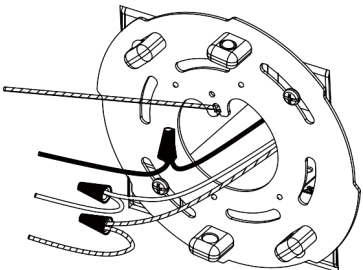
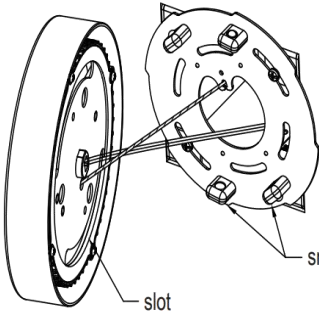
<p>Downlight Installation Instruction</p>	
	<p>2. When ready to make the wire connections, first install the Safety Installation Cable from light fixture by pushing into the "key hole" in bracket.</p>  <p>slot steel wire</p>
	<p>4. Push and feed all wires up into Junction Box as you raise the fixture up into place with right channel.</p>  <p>slot snap joint</p>
<p>3. Make the wire connections with wire nuts . The green(ground wire) of housing to green of fixture, Connect white(neutral wire) to white; black(live wire) to black.</p>	

*Other special requirements please confirm with our factory



Liteharbor Lighting Technology Co., Ltd.
 New Industry Area Hecun Danzao Town
 Nanhai Foshan City Guangdong China

TEL: +86-757-8180 8687
 FAX: +86-757-8180 8685
 E-mail: info@liteharbor.com

Website: www.liteharbor.com
 Specifications subject to change w/o no
 Revision: Jun. 2022