

SPECIFICATION SHEET

Ardito LED - A2SSF

2-1/2" Series (DL2SSF)

2-1/2" Series

Ultra-Thin Profile Square Regressed Shower Trim

Project _____

Notes _____

Fixture Type _____

Date _____



A2SSF-11-XXX (illustrated)
(DL2SSF-11-XXX)0

Ultra-Thin Profile Square Regressed Shower Trim 2-1/2" high-efficiency dimmable LED downlight. Offered in Remodel NON-IC (with optional mounting plate), new construction NON-IC and new construction IC configurations.



SPECIFICATIONS

TRIM DETAILS	<p>Requires a 5" (127 mm) clearance beyond the ceiling level when used with remodel or new construction NON-IC housings.</p> <p>Each part of the housing should be at LEAST 3" (76 mm) from insulation (non-IC configurations)</p> <p>Can fit in ceiling from 1/2" (12 mm) to 1-3/8" (35 mm) thick</p> <p>Accessible from below the ceiling for ease of maintenance.</p>
HEAT SINK	High-quality injection molded aluminum heat sink ensuring maximum heat dissipation for optimal performance.
CEILING CUTOUT	<p>2-5/8" (67 mm) x 2-5/8" (67 mm)</p> <p>Included: Cardboard cutout template</p> <p>Optional: Reusable steel cutout template for square trim (TEMP-SQ)</p>
CERTIFICATION	<ul style="list-style-type: none"> cULus E343977 for wet locations Certified under California Energy Commission according to reference joint Appendix 8 (JA8-2016) Certified Air Tight ASTM E283
WARRANTY	<p>1 year on components against manufacturing defects</p> <p>5 years on LED arrays and drivers</p>

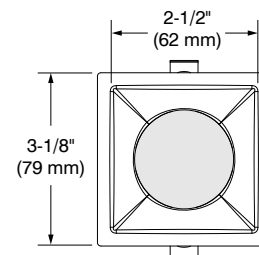
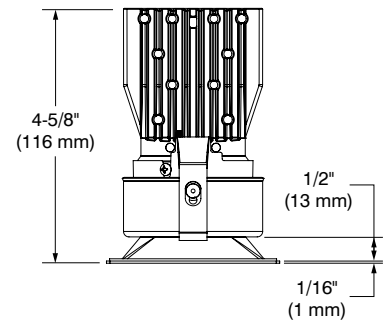

Liteharbor Lighting Technology Co., Ltd.

New Industry Area Hecun Danzao Town Nanhai
Foshan City Guangdong China

Tel.: +86-757-81808688
Fax.: +86-757-81808685
info@liteharbor.com
liteharbor.com
liteharborfactory.com

© 2021 Liteharbor Lighting Technology Co., Ltd.
All rights reserved
Liteharbor Lighting Technology Co., Ltd. reserves the right to make changes in specifications and/or to discontinue any product at any time without notice or obligation and will not be liable for any consequences resulting from the use of this publication.

SPECIFICATION SHEET

Ardito LED - A2SSF

(DL2SSF)

2-1/2" Series

Ultra-Thin Profile Square Regressed Shower Trim



SPECIFICATIONS (CONT'D)

COMPATIBLE HOUSINGS

	Remodel Housing	New Construction Housing	Insulated Air Tight Housing (Title 24)	IC AIR TIGHT AFTER THE FACT	T24
Performance 1 (14W)	REA2V1	NWA2SV1	ICAT0S2-ARV1	JA8 LISTED	

For dimming, please visit our Web site frequently to find our suggested compatible dimmers: www.contrastlighting.com

LIGHT ENGINE

STANDARD (SOLID WHITE)

Lumileds Luxeon CoB 1203 GEN3.

L₇₀ @ 50,000 hours of operation.

3-Step MacAdam ellipse (3 SDCM)

Color Temperatures: 2,700K - 3,000K - 3,500K - 4,000K

CRI: 90+

R9: >50

Delivered Lumens: Performance 1 (14W) **with clear lens** - up to 1,375 lumens (95 lm/W)

Performance 1 (14W) **with frosted lens** - up to 975 lumens (68 lm/W)

Power Supply: 120V / 277V (universal input)

One driver available in performance 1 (14W) and offering 2 dimming options within the same unit:

ELV: 120V only

0-10V: 120V / 277V

Consult housing specification sheet for more details.

WARM DIMMING (WD)

LED module mimicking the halogen lamp dimming conditions by lowering color temperature from 3,050K at full intensity down to 1,800K at low-end while ensuring 94+ CRI throughout the whole process.

L₇₀ @ 50,000 hours of operation.

3-Step MacAdam ellipse (3 SDCM)

Color Temperatures: 3,050K to 1,800K

CRI: 94+ (over the entire dimming range)

R9: >85

Delivered Lumens: Performance 1 (14W) 775 lumens @ 3,000K (55 lm/W)

Power Supply: 120V / 277V (universal input)

One driver available in performance 1 (14W) and offering 2 dimming options within the same unit:

ELV: 120V only

0-10V: 120V / 277V

Consult housing specification sheet for more details.



Liteharbor Lighting Technology Co., Ltd.

New Industry Area Hecun Danzao Town Nanhai
Foshan City Guangdong China

Tel.: +86-757-81808688
Fax.: +86-757-81808685
info@liteharbor.com
liteharbor.com
liteharborfactory.com

© 2021 Liteharbor Lighting Technology Co., Ltd.
All rights reserved
Liteharbor Lighting Technology Co., Ltd. reserves the right to make changes in specifications and/or to discontinue any product at any time without notice or obligation and will not be liable for any consequences resulting from the use of this publication.

SPECIFICATION SHEET

Ardito LED - A2SSF

(DL2SSF)

2-1/2" Series

Ultra-Thin Profile Square Regressed Shower Trim



SPECIFICATIONS (CONT'D)

OPTIC SYSTEM

Interchangeable optional optical reflectors and lenses available to customize your lighting.

Choice of available lenses:

Clear (C) 

Frosted (F)

Optical reflectors available: Spot, Narrow Flood, Flood, Wide Flood

Standard

Spot (S)	15°
Narrow Flood (M)	24°
Flood (L)	36°
Wide Flood (V)	60°

Warm Dimming (WD)

Narrow Flood (M)	25°
Flood (L)	40°

Average beams shown. Consult .ies files on our Web site for more details.

 FLANGE AND
REFLECTOR
FINISHES

Powder coat painted or plated die formed steel.

Different finishes available: (Options in red may generate a longer production lead time)

24K Gold Plated **(-03)**, Brushed Chrome **(-04BR)**, Matte White **(-11)**, Brushed Nickel **(-12BR)**, Satin Nickel **(-13)**, Matte Black **(-22)** and Polar Grey **(-25)**



Liteharbor Lighting Technology Co., Ltd.

New Industry Area Hecun Danzao Town Nanhai
Foshan City Guangdong China

Tel.: +86-757-81808688
Fax.: +86-757-81808685
info@liteharbor.com
liteharbor.com
liteharborfactory.com

© 2021 Liteharbor Lighting Technology Co., Ltd.
All rights reserved
Liteharbor Lighting Technology Co., Ltd. reserves the right to make changes in specifications and/or to discontinue any product at any time without notice or obligation and will not be liable for any consequences resulting from the use of this publication.

SPECIFICATION SHEET

Ardito LED - A2SSF

(DL2SSF)

2-1/2" Series

Ultra-Thin Profile Square Regressed Shower Trim



TRIM WITH FLANGE CODIFICATION EXAMPLE

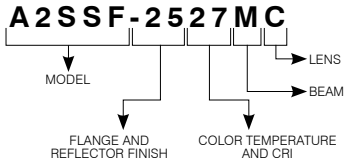

Options in red may generate a longer production lead time.

ORDERING CODES **A2SSF**

MODEL	FLANGE AND REFLECTOR FINISHES	COLOR TEMPERATURES AND CRI	BEAMS	LENSES
A2SSF (DL2SSF)	-04BR Brushed Chrome	27 2,700K (90+ CRI)	S Spot (15°)	C Clear
	-11 Matte White	30 3,000K (90+ CRI)	M Narrow Flood (24°) Narrow Flood — WD (25°)	F Frosted
	-12BR Brushed Nickel	35 3,500K (90+ CRI)	L Flood (36°) Flood — WD (40°)	
	-22 Matte Black	40 4,000K (90+ CRI)	V Wide Flood (60°)	
	-25 Polar Grey	WD Warm Dimming 3,050K to 1,800K (90+ CRI)		
	-03 24K Gold Plated			
	-13 Satin Nickel			

REUSABLE TEMPLATE OPTION

Reusable steel cutout template for square trim.

Code: **TEMP-SQ**

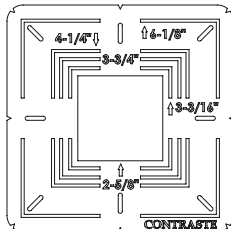

ORDERING CODES

for replacement lenses and reflectors

For future on-site modifications of the light distribution.

Lenses (to modify light diffusion)

Clear (C): **103584**

Frosted (F): **316228**

Reflectors (to modify the beam angle)

For a Spot (15°): **104419**

For a Narrow Flood (24°): **104420**

For a Flood (36°): **104421**

For a Wide Flood (60°): **104422**

For a Narrow Flood — Warm Dimming (WD) (25°): **104571**

For a Flood — Warm Dimming (WD) (40°): **104573**



Liteharbor Lighting Technology Co., Ltd.

New Industry Area Hecun Danzao Town Nanhai
Foshan City Guangdong China

Tel.: +86-757-81808688
Fax.: +86-757-81808685
info@liteharbor.com
liteharbor.com
liteharborfactory.com

© 2021 Liteharbor Lighting Technology Co., Ltd.

All rights reserved
Liteharbor Lighting Technology Co., Ltd. reserves the right to make changes in specifications and/or to discontinue any product at any time without notice or obligation and will not be liable for any consequences resulting from the use of this publication.

SPECIFICATION SHEET

Ardito LED - A2SSF

(DL2SSF)

2-1/2" Series

Ultra-Thin Profile Square Regressed Shower Trim

PHOTOMETRIC DATA



PHOTOMETRIC DATA

In order to obtain the accurate photometric data, multiply the lumens relative to your product selection by the applicable factor(s).
Take note these factors also need to be implemented in the .ies files available on our website.

STANDARD	Spot (15°)		Narrow Flood (24°)		Flood (36°)		Wide Flood (60°)	
	lm	lm/W	lm	lm/W	lm	lm/W	lm	lm/W
2,700K with 90+ CRI	1,225	85.1	1,080	75	1,075	74.6	1,070	74.3
3,000K with 90+ CRI	1,270	88.2	1,115	77.4	1,110	77.1	1,105	76.7
3,500K with 90+ CRI	1,340	93.1	1,180	81.9	1,175	81.6	1,170	81.3
4,000K with 90+ CRI	1,375	95.5	1,210	84	1,205	83.7	1,200	83.3

Lens Factors			
C	1	H	0.57
F	0.71		

WARM DIMMING (WD)	Narrow Flood (25°)		Flood (40°)	
	lm	lm/W	lm	lm/W
Warm Dimming with 94+ CRI	765	55	775	55

Lens Factors	
Std	1
C	0.92



Liteharbor Lighting Technology Co., Ltd.

New Industry Area Hecun Danzao Town Nanhai
Foshan City Guangdong China

Tel.: +86-757-81808688
Fax.: +86-757-81808685
info@liteharbor.com
liteharbor.com
liteharborfactory.com

© 2021 Liteharbor Lighting Technology Co., Ltd.
All rights reserved
Liteharbor Lighting Technology Co., Ltd. reserves the right to make changes in specifications and/or to discontinue any product at any time without notice or obligation and will not be liable for any consequences resulting from the use of this publication.

SPECIFICATION SHEET

Ardito LED - A2SSF (DL2SSF)

2-1/2" Series

Ultra-Thin Profile Square Regressed Shower Trim

PHOTOMETRIC DATA



3,000K, 90+ CRI, Spot, Performance 1 — WITH CLEAR LENS

CANDLEPOWER DISTRIBUTION

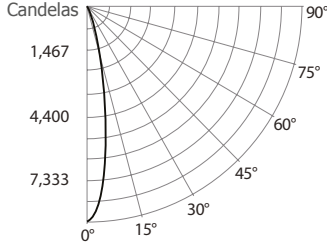

LIGHT CONE

Distance	FC	DIA
06'	242.1	1.7'
08'	136.2	2.3'
10'	87.2	2.8'
12'	60.5	3.4'
14'	44.5	4.0'
16'	34.0	4.5'

Beam: 16°
Beam Edge defined as 50% of Maximum Nadir Candle-power.

LUMINAIRE

Performance 1 LED	3,000K	Spot
CBCP / Lumens	8,715	/ 1,267.3
Watts	120V	277V
	14.4W	14.9W
Operating AMPS	0.12A	0.054A
Lumen Maintenance	L70 @ 50,000 Hrs	
CRI	90+	
Lumens/Watt	88	
Spacing Criteria	0.07	

COEFFICIENT OF UTILIZATION - %

Ceiling Reflect %	80		50		30		
Wall Reflect %	50	30	50	30	50	30	
RCR	0	119	119	111	111	106	106
	2	108	105	103	101	100	99
	4	100	96	97	94	95	92
	6	93	89	91	88	90	87
	8	87	83	86	83	85	82
	10	83	79	82	78	81	78

Zonal Cavity Method
Effective Floor Cavity Reflectance 20%

ZONAL LUMEN SUMMARY

ZONE	LUMENS	%LUMINAIRE
0-30	1,114.8	94.8%
0-40	1,176.1	100%
0-60	1,176.1	100%
60-90	0.0	0%
0-180	1,176.1	100%

MULTIPLE UNIT DATA - (RCR 2)

SPACING ON CENTER	INITIAL FOOTCANDLES	WATTS/SQ. FT.
5'	59	0.64
6'	33	0.36
7'	23	0.25
8'	23	0.25
9'	15	0.16

38' x 38' x 10' Room. Workplan located 2-1/2' (30").
Reflectance factor 80%/50%/30%

CANDELAS DISTRIBUTION

DEGREES/VERTICAL	CANDELAS	DEGREES/VERTICAL	CANDELAS
0	8,715	40	0
5	6,473	50	0
10	3,037	60	0
15	1,150	70	0
20	724	80	0
25	535	90	0
30	328		

3,000K, 90+ CRI, Narrow Flood, Performance 1 — WITH CLEAR LENS

CANDLEPOWER DISTRIBUTION

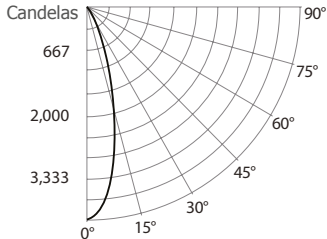

LIGHT CONE

Distance	FC	DIA
06'	111	2.9'
08'	62.5	3.9'
10'	39.9	4.8'
12'	27.8	5.8'
14'	20.4	6.7'
16'	15.6	7.7'

Beam: 27°
Beam Edge defined as 50% of Maximum Nadir Candle-power.

LUMINAIRE

Performance 1 LED	3,000K	Narrow Flood
CBCP / Lumens	3,997	/ 1,133.8
Watts	120V	277V
	14.4W	14.9W
Operating AMPS	0.12A	0.054A
Lumen Maintenance	L70 @ 50,000 Hrs	
CRI	90+	
Lumens/Watt	78.7	
Spacing Criteria	0.12	

COEFFICIENT OF UTILIZATION - %

Ceiling Reflect %	80		50		30		
Wall Reflect %	50	30	50	30	50	30	
RCR	0	119	119	111	111	106	106
	2	107	104	102	100	99	97
	4	97	93	94	91	92	90
	6	90	85	87	84	86	83
	8	83	79	82	78	81	77
	10	77	73	76	73	76	72

Zonal Cavity Method
Effective Floor Cavity Reflectance 20%

ZONAL LUMEN SUMMARY

ZONE	LUMENS	%LUMINAIRE
0-30	1,055.6	93.1%
0-40	1,130.2	99.7%
0-60	1,133.8	100%
60-90	0.0	0%
0-90	1,133.8	100%

MULTIPLE UNIT DATA - (RCR 2)

SPACING ON CENTER	INITIAL FOOTCANDLES	WATTS/SQ. FT.
5'	56	0.64
6'	32	0.36
7'	22	0.25
8'	22	0.25
9'	14	0.16

38' x 38' x 10' Room. Workplan located 2-1/2' (30").
Reflectance factor 80%/50%/30%

CANDELAS DISTRIBUTION

DEGREES/VERTICAL	CANDELAS	DEGREES/VERTICAL	CANDELAS
0	3,997	40	14
5	3,654	50	1
10	2,742	60	0
15	1,699	70	0
20	944	80	0
25	570	90	0
30	337		



Liteharbor Lighting Technology Co., Ltd.

New Industry Area Hecun Danzao Town Nanhai
Foshan City Guangdong China

Tel.: +86-757-81808688
Fax: +86-757-81808685
info@liteharbor.com
liteharbor.com
liteharborfactory.com

© 2021 Liteharbor Lighting Technology Co., Ltd.
All rights reserved
Liteharbor Lighting Technology Co., Ltd. reserves the right to make changes in specifications and/or to discontinue any product at any time without notice or obligation and will not be liable for any consequences resulting from the use of this publication.

Ardito LED - A2SSF (DL2SSF)

2-1/2" Series

Ultra-Thin Profile Square Regressed Shower Trim

PHOTOMETRIC DATA



3,000K, 90+ CRI, Flood Performance 1 — WITH CLEAR LENS

CANDLEPOWER DISTRIBUTION

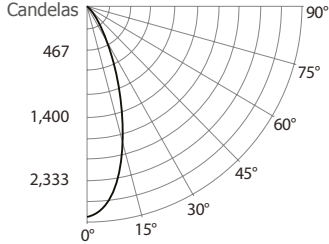

LIGHT CONE

Distance	FC	DIA
06'	76.3	3.7'
08'	42.9	5.0'
10'	27.5	6.2'
12'	19.1	7.5'
14'	14	8.7'
16'	10.7	10'

Beam: 35°
Beam Edge defined as 50% of Maximum Nadir Candle-power.

LUMINAIRE

Performance 1 LED	3,000K Flood
CBCP / Lumens	2,745 / 1,084.3
Watts	120V 277V 14.4W 14.9W
Operating AMPS	0.12A 0.054A
Lumen Maintenance	L70 @ 50,000 Hrs
CRI	90+
Lumens/Watt	75.3
Spacing Criteria	0.15

COEFFICIENT OF UTILIZATION - %

Ceiling Reflect %	80	50	30				
Wall Reflect %	50	30	50	30	50	30	
RCR	0	119	119	111	111	106	106
	2	106	103	101	99	98	96
	4	96	91	93	89	91	88
	6	87	83	85	81	84	80
	8	80	75	79	75	78	74
	10	74	70	73	69	72	69

Zonal Cavity Method
Effective Floor Cavity Reflectance 20%

ZONAL LUMEN SUMMARY

ZONE	LUMENS	%LUMINAIRE
0-30	997.4	92%
0-40	1065.6	98.3%
0-60	1081.4	99.7%
60-90	2.9	0.3%
0-180	1084.3	100%

MULTIPLE UNIT DATA - (RCR 2)

SPACING ON CENTER	INITIAL FOOTCANDLES	WATTS/SQ. FT.
5'	54	0.64
6'	30	0.36
7'	21	0.25
8'	21	0.25
9'	13	0.16

38' x 38' x 10' Room. Workplan located 2-1/2' (30").
Reflectance factor 80%/50%/30%

CANDELAS DISTRIBUTION

DEGREES/VERTICAL	CANDELAS	DEGREES/VERTICAL	CANDELAS
0	2,745	40	22
5	2,612	50	8
10	2,246	60	5
15	1,659	70	1
20	1,083	80	0
25	677	90	0
30	338		

3,000K, 90+ CRI, Wide Flood, Performance 1 — WITH CLEAR LENS

CANDLEPOWER DISTRIBUTION

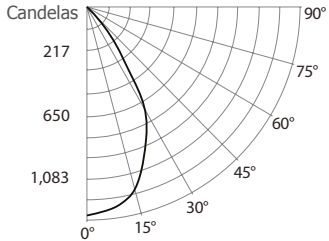

LIGHT CONE

Distance	FC	DIA
06'	35.7	7.1'
08'	20.1	9.5'
10'	12.9	11.9'
12'	8.9	14.2'
14'	6.6	16.6'
16'	5.0	19.0'

Beam: 61°
Beam Edge defined as 50% of Maximum Nadir Candle-power.

LUMINAIRE

Performance 1 LED	3,000K Wide Flood
CBCP / Lumens	1,285 / 1,211.5
Watts	120V 277V 14.4W 14.9W
Operating AMPS	0.12A 0.054A
Lumen Maintenance	L70 @ 50,000 Hrs
CRI	90+
Lumens/Watt	84.1
Spacing Criteria	0.25

COEFFICIENT OF UTILIZATION - %

Ceiling Reflect %	80	50	30				
Wall Reflect %	50	30	50	30	50	30	
RCR	0	119	119	111	111	106	106
	2	103	98	98	95	95	92
	4	89	83	85	81	83	80
	6	78	71	75	70	74	69
	8	68	62	67	61	66	61
	10	61	55	60	54	59	54

Zonal Cavity Method
Effective Floor Cavity Reflectance 20%

ZONAL LUMEN SUMMARY

ZONE	LUMENS	%LUMINAIRE
0-30	829.0	68.4%
0-40	1,070.9	88.4%
0-60	1,206.8	99.6%
60-90	4.7	0.4%
0-90	1,211.5	100%

MULTIPLE UNIT DATA - (RCR 2)

SPACING ON CENTER	INITIAL FOOTCANDLES	WATTS/SQ. FT.
5'	58	0.64
6'	33	0.36
7'	23	0.25
8'	23	0.25
9'	15	0.16

38' x 38' x 10' Room. Workplan located 2-1/2' (30").
Reflectance factor 80%/50%/30%

CANDELAS DISTRIBUTION

DEGREES/VERTICAL	CANDELAS	DEGREES/VERTICAL	CANDELAS
0	1,285	40	208
5	1,275	50	71
10	1,239	60	9
15	1,135	70	1
20	992	80	0
25	864	90	0
30	685		



Liteharbor Lighting Technology Co., Ltd.

New Industry Area Hecun Danzao Town Nanhai
Foshan City Guangdong China

Tel.: +86-757-81808688
Fax.: +86-757-81808685
info@liteharbor.com
liteharbor.com
liteharborfactory.com

© 2021 Liteharbor Lighting Technology Co., Ltd.
All rights reserved
Liteharbor Lighting Technology Co., Ltd. reserves the right to make changes in specifications and/or to discontinue any product at any time without notice or obligation and will not be liable for any consequences resulting from the use of this publication.

Ardito LED - A2SSF (DL2SSF)

2-1/2" Series

Ultra-Thin Profile Square Regressed Shower Trim

PHOTOMETRIC DATA



3,000K, 94+ CRI, Narrow Flood, Performance 1 — WARM DIMMING (WD)

CANDLEPOWER DISTRIBUTION

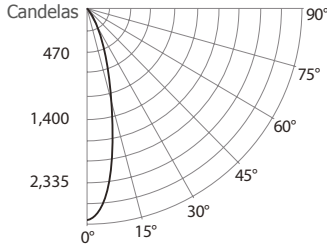

LIGHT CONE

Distance	FC	DIA
06'	76.4	2.7'
08'	42.9	3.5'
10'	27.5	4.4'
12'	19.1	5.3'
14'	14.0	6.2'
16'	10.8	7.1'

Beam: 24.9°
Beam Edge defined as 50% of Maximum Nadir Candle-power.

LUMINAIRE

Performance 1 LED	3,000K	Narrow Flood
CBCP / Lumens	2,751 / 762.7	
Watts	120V 14.9W	277V 15.4W
Operating AMPS	0.12A	0.055A
Lumen Maintenance	L70 @ 50,000 Hrs	
CRI	94+	
Lumens/Watt	51.2	
Spacing Criteria	0.23	

COEFFICIENT OF UTILIZATION - %

Ceiling Reflect %	80		50		30		
Wall Reflect %	50	30	50	30	50	30	
RCR	0	119	119	111	111	106	106
	2	106	103	101	99	98	96
	4	96	91	92	89	91	87
	6	87	82	85	81	84	80
	8	80	75	79	75	78	74
	10	74	70	73	69	73	69

Zonal Cavity Method
Effective Floor Cavity Reflectance 20%

ZONAL LUMEN SUMMARY

ZONE	LUMENS	%LUMINAIRE
0-30	641.5	84.1%
0-40	726.8	95.3%
0-60	762.6	100%
60-90	0	0%
0-180	762.7	100%

MULTIPLE UNIT DATA - (RCR 2)

SPACING ON CENTER	INITIAL FOOTCANDLES	WATTS/SQ. FT.
5'	28	0.50
6'	29	0.51
7'	21	0.37
8'	15	0.26
9'	15	0.26

38' x 38' x 10' Room. Workplan located 2-1/2' (30").
Reflectance factor 80%/50%/30%

CANDELAS DISTRIBUTION

DEGREES/VERTICAL	CANDELAS	DEGREES/VERTICAL	CANDELAS
0	2,751	40	71
5	2,455	50	17
10	1,804	60	0
15	1,044	70	0
20	518	80	0
25	327	90	0
30	224		

3,000K, 94+ CRI, Flood, Performance 1 — WARM DIMMING (WD)

CANDLEPOWER DISTRIBUTION

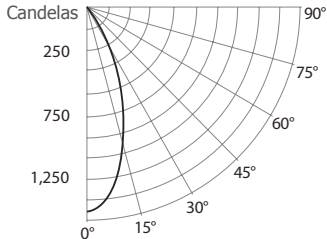

LIGHT CONE

Distance	FC	DIA
06'	40.4	4.5'
08'	22.7	6.0'
10'	14.5	7.5'
12'	10.1	9.0'
14'	7.4	10.5'
16'	5.7	12.0'

Beam: 41.1°
Beam Edge defined as 50% of Maximum Nadir Candle-power.

LUMINAIRE

Performance 1 LED	3,000K	Wide Flood
CBCP / Lumens	1,453 / 774.9	
Watts	120V 14.8W	277V 15.3W
Operating AMPS	0.12A	0.055A
Lumen Maintenance	L70 @ 50,000 Hrs	
CRI	94+	
Lumens/Watt	52.4	
Spacing Criteria	1.99	

COEFFICIENT OF UTILIZATION - %

Ceiling Reflect %	80		50		30		
Wall Reflect %	50	30	50	30	50	30	
RCR	0	119	119	111	111	106	106
	2	105	101	100	97	97	94
	4	93	88	89	86	88	84
	6	83	78	81	76	79	76
	8	75	70	73	69	72	68
	10	68	63	67	62	66	62

Zonal Cavity Method
Effective Floor Cavity Reflectance 20%

ZONAL LUMEN SUMMARY

ZONE	LUMENS	%LUMINAIRE
0-30	620.8	80.1%
0-40	725.3	93.6%
0-60	774.7	100%
60-90	0.2	0%
0-90	774.9	100%

MULTIPLE UNIT DATA - (RCR 2)

SPACING ON CENTER	INITIAL FOOTCANDLES	WATTS/SQ. FT.
5'	28	0.49
6'	29	0.50
7'	21	0.37
8'	15	0.26
9'	15	0.26

38' x 38' x 10' Room. Workplan located 2-1/2' (30").
Reflectance factor 80%/50%/30%

CANDELAS DISTRIBUTION

DEGREES/VERTICAL	CANDELAS	DEGREES/VERTICAL	CANDELAS
0	1,453	40	95
5	1,364	50	24
10	1,199	60	0
15	984	70	0
20	716	80	0
25	444	90	0
30	255		



Liteharbor Lighting Technology Co., Ltd.

New Industry Area Hecun Danzao Town Nanhai
Foshan City Guangdong China

Tel.: +86-757-81808688
Fax.: +86-757-81808685
info@liteharbor.com
liteharbor.com
liteharborfactory.com

© 2021 Liteharbor Lighting Technology Co., Ltd.
All rights reserved
Liteharbor Lighting Technology Co., Ltd. reserves the right to make changes in specifications and/or to discontinue any product at any time without notice or obligation and will not be liable for any consequences resulting from the use of this publication.