

# A35-M-1 High Performance 3.5" COB LED Recessed Downlight Kits

Catalog #		Prepared by		LiteHarbor
Project		Date		
Notes				



## DESCRIPTION

3.5 inch LED recessed fixtures with round or square apertures offer energy-efficient, precision lighting for accent, task, or wall wash applications.

This type LED luminaire approximates the performance of 50W halogen, but at only 12-watts input, consumes just one-fourth the energy.

A feature enriched, small aperture downlight, the innovative design allows the LED to be positioned closer to the aperture for maximum light output and efficiency or higher to minimize glare and flash on the trim.

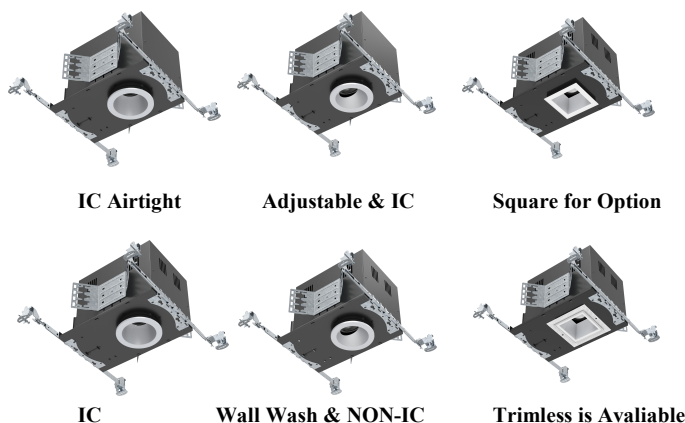

## FEATURES

- PoE scheme or LED quick connector provided.
- Robust, durable and lightweight.
- Power & CCT Tunable, convenient inventory and cost savings.
- No Flickering, noise or RF interference
- Easy to install to suspended ceiling grids.
- Up to 80lm/W, total 1000lm to 2000lm delivered lumens (2700K-6000K) .
- 5 classic color temperatures tunable (2700K, 3000K, 3500K, 4000K, 5000K), RGB+Tunable White(2700K-6000K) and Tunable White (1800K-6000K) .
- Isolated constant current drive power supply, safe and stable guarantee without strobe, standard dimming control, matching most dimmers.
- Beam angle: 12/24/36°
- Available in trimmed or trimless.
- Universal 120V-277V driver with optional 0-10V standard dimming protocol.

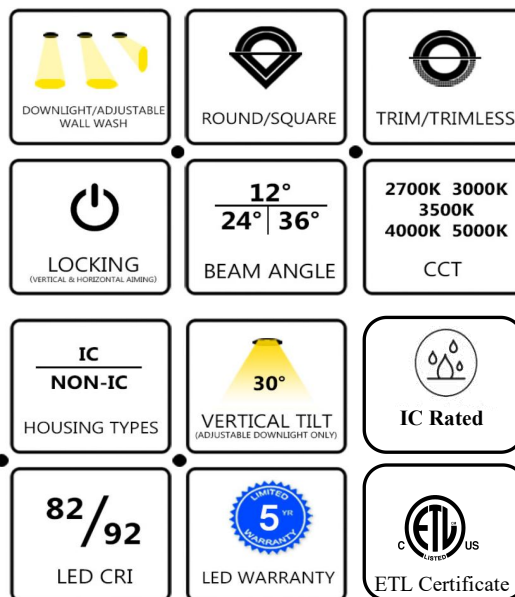

\*Other special requirements please confirm with our sales.

 <p><b>Liteharbor Lighting Technology Co., Ltd.</b> New Industry Area Hecun Danzao Town Nanhai Foshan City Guangdong China</p>	<p>TEL: +86-757-8180 8687</p>	<p>Website: <a href="http://www.liteharbor.com">www.liteharbor.com</a></p>
	<p>FAX: +86-757-8180 8685</p> <p>E-mail: <a href="mailto:info@liteharbor.com">info@liteharbor.com</a></p>	<p>Specifications subject to change w/o notice</p> <p>Revision: Sep. 2022</p>

RECESSED DOWNLIGHT

## HOUSING

Heavy duty black powder coated cold roll steel frame.  
 Design for New Construction installation.  
 Housing can be installed in 1/2" to 1-3/8" thick ceilings.  
 Housing types include IC Air-Tight or IC Rated (must specify).  
 Junction box and driver are located on opposite ends of the housing, with easy access for maintenance and installation.  
 Optional round or square aperture shape.  
 Trimless design is available.

## OPTICS



## APPLICATIONS

Widely used for commercial and residential applications.

## SPECIFICATION

DESCRIPTION	A35-M-1			
Wattage	12W	15W	20W	25w
Luminous Flux	1000lm	1300lm	1600lm	2000lm
Lumens / Watt	80lm/w			
CRI	80+ / 90+			
Colour Temperature	2700K, 3000K, 3500K, 4000K,5000K,6000K/3CCT/5CCT			
Driver Input	DC 24V /Universal 120V or 277V			
Dimming	Tunable White / Dim to Warm / TRIAC Dimming / 0-10V Dimming			
Optics	12° / 24° / 36°			
Location	Insulated Ceiling & Damp Locations			
Finish	White,Black,Satin Nickel			
Working Humidity	10% – 70%			
IP Rating	20			
UGR	<18			
Beam Angle	120°			
THD	<20%			
Installation	Recessed Ceiling Mount			
Lifespan	50,000 Hours at 70% Light Output			
Executive Standard	ETL			
Warranty	5 Year Limited			

## LED LIGHT ENGINE

Optional branded COB LED chips  
 Input DC 24V or AC 120V 230V 277V ( 90-305V is optional  
 12W 15W 20W  
 1000 1300 1600 Lumens  
 2700K, 3000K, 3500K, 4000K,5000K and 6000K at 80+ CRI  
 2700K, 3000K, 3500K, 4000K,5000K and 6000K at 90+ CRI  
 PF > 0.98  
 Dimmable options: NONE, TRIAC or RD 0-10V  
 LED mounted to die-cast / extruded aluminum heat sink w/  
 active cooling  
 50,000 hours average rated life at 70% output

## LISTING/WARRANTY

ETL listed to US and Canadian standards for damp location  
 W/Feed through.  
 5 Year Limited Warranty.



RECESSED DOWNLIGHT

\*Other special requirements please confirm with our sales.



**Liteharbor Lighting Technology Co., Ltd.**  
 New Industry Area Hecun Danzao Town  
 Nanhai Foshan City Guangdong China

TEL: +86-757-8180 8687  
 FAX: +86-757-8180 8685  
 E-mail: info@liteharbor.com

Website: www.liteharbor.com  
 Specifications subject to change w/o notice  
 Revision: Sep. 2022

## VERTICAL DOWNLIGHT

With precision optics and adjustments, luminaires put exactly the right amount of light in precisely the right places.

Round type can achieve 3 beam angles without replacing any parts.

Allow for 358 degree rotation.

Vertical downlight used with vertical reflector matched.

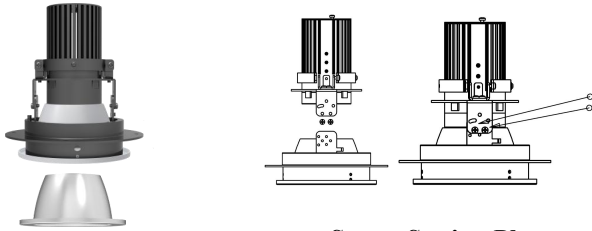

Screw Setting Place

## ADJUSTABLE DOWNLIGHT

Additional adjustability allows for locking including 0°-30° tilt and 358° rotation while always maintaining center beam candle power.

Adjustable downlight used with adjustable reflector matched.

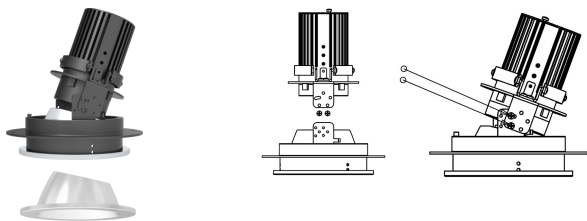

Screw Setting Place

## WALL WASH DOWNLIGHT

High performance wall wash with asymmetric distribution provides uniform illumination.

Allow for 358 degree rotation.

Wall wash downlight used with wall washing reflector matched.

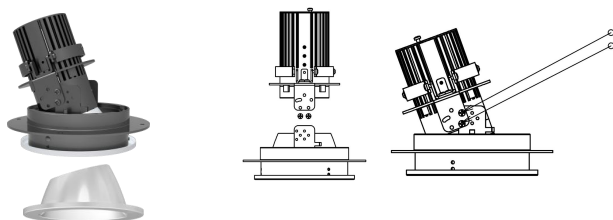

Screw Setting Place

## Downlight Beam Angles

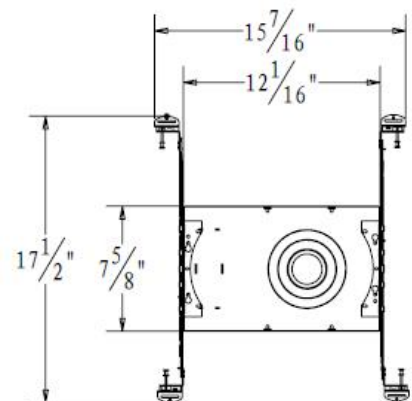
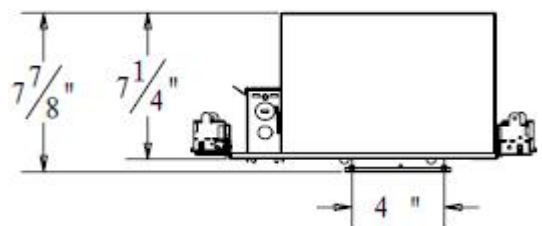
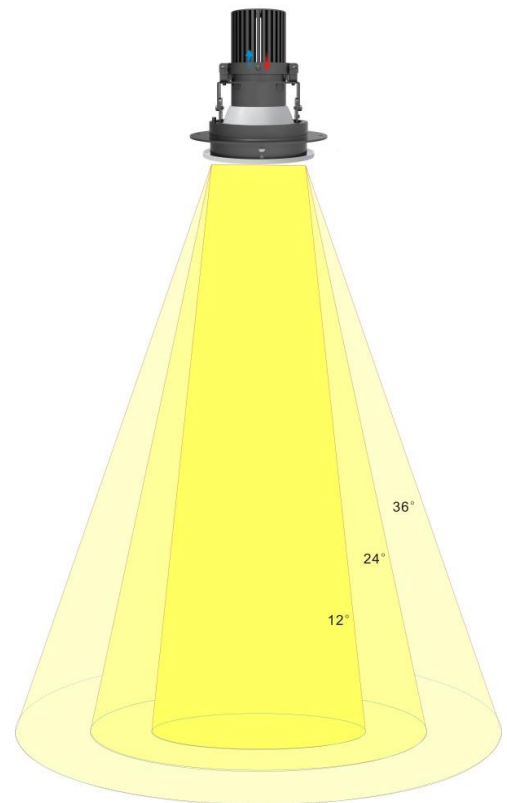

RECESSED DOWNLIGHT

\*Other special requirements please confirm with our sales.



**Liteharbor Lighting Technology Co., Ltd.**

New Industry Area Hecun Danzao Town  
Nanhai Foshan City Guangdong China

TEL: +86-757-8180 8687

FAX: +86-757-8180 8685

E-mail: info@liteharbor.com

Website: www.liteharbor.com

Specifications subject to change w/o notice

Revision: Sep. 2022

**Order Matrix** | Example: A35-M-1-S-W-IC-TL

**A B C D E F G H I J**  
**K L**

**Item No.:A35-M-1**

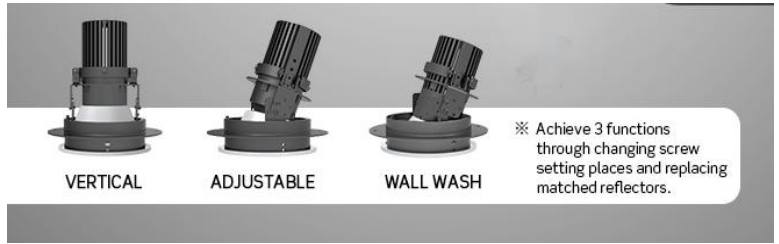

A	Series	D	IC Rated Type	B	Aperture Opening	E	Trim
A35-M-1	3.5" Downlight	IC	IC	Round		Trimmed	
		IA	IC Airtight	S	Square	TL	Trimless

K	Color Temperature	G	Finish	J	Beam Angle	F	Install
27K	2700K	WH	White	12°	12° Spot		General Bar Hanger
30K	3000K	BK	Black	24°	24° Spot	C	C-channel Bar Hanger
35K	3500K	SN	Satin Nickel	36°	36° Spot		
40K	4000K						
50K	5000K						
60K	6000K						

L	Dimmable	H	LED Available	C	Functions	I	Wattage/Lumen
	Non-Dimmable	CREE	CREE		Vertical Downlight	L12	LED 12W/1000 Lumen
TD	TRIAC Dimming	Citizen	Citizen	A	Adjustable Downlight	L15	LED 15W/1300 Lumen
D	0-10V Dimming	Epistar	Epistar	W	Wall Wash Downlight	L20	LED 20W/1600 Lumen
		Seoul	Seoul			L25	LED 25W/2000 Lumen
		Osram	Osram				

RECESSED DOWNLIGHT

\*Other special requirements please confirm with our sales.

 <p><b>Liteharbor Lighting Technology Co., Ltd.</b> New Industry Area Hecun Danzao Town Nanhai Foshan City Guangdong China</p>	TEL: +86-757-8180 8687	Website: www.liteharbor.com
	FAX: +86-757-8180 8685	Specifications subject to change w/o notice
	E-mail: info@liteharbor.com	Revision: Sep. 2022

## TOP POE BENEFITS INCLUDE

- ◆ Further Cost Savings
- ◆ Easy, Low-Voltage Installation
- ◆ Helps future-proof buildings
- ◆ Enhanced Flexibility and Control
- ◆ Enables software control integration
- ◆ Social Benefits
- ◆ Robust, Secure and Reliable

## ADVANTAGES OF POE

The primary advantage of power over ethernet is the delivery of data and power over one Cat5 or Cat6 ethernet cable.

Remote installation generally costs less than optical fiber and does not require a qualified electrician, saving building owners valuable time and labor costs.

One of the biggest advantages of PoE technology is cost savings.

PoE installation is cheaper than traditional electrical work, operating costs are lower over the course of the PoE lifetime and data can inform further decisions to save costs — all without sacrificing lighting quality for occupants.

## POWER OVER ETHERNET LIGHTING

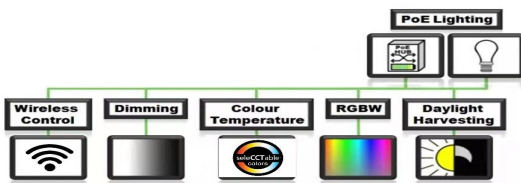

## POE SOLUTION

The wiring diagram

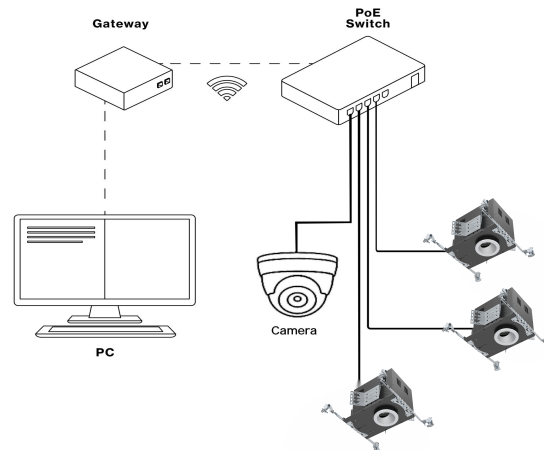

\*Other special requirements please confirm with our sales.

## WHY USE POE LIGHTING

PoE lighting reduces power, material, labor and maintenance.

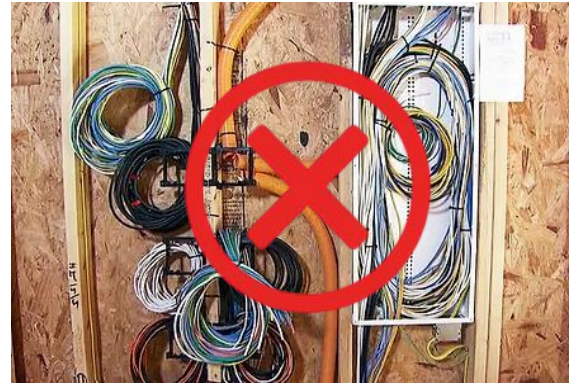

70% Cost Saving

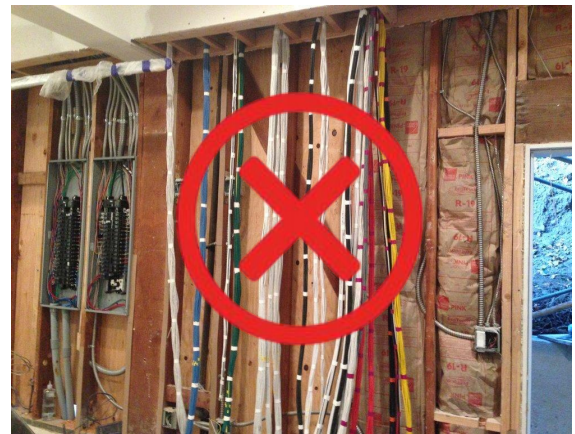

RECESSED DOWNLIGHT



**Liteharbor Lighting Technology Co., Ltd.**  
 New Industry Area Hecun Danzao Town  
 Nanhai Foshan City Guangdong China

TEL: +86-757-8180 8687  
 FAX: +86-757-8180 8685  
 E-mail: info@liteharbor.com

Website: www.liteharbor.com  
 Specifications subject to change w/o notice  
 Revision: Sep. 2022

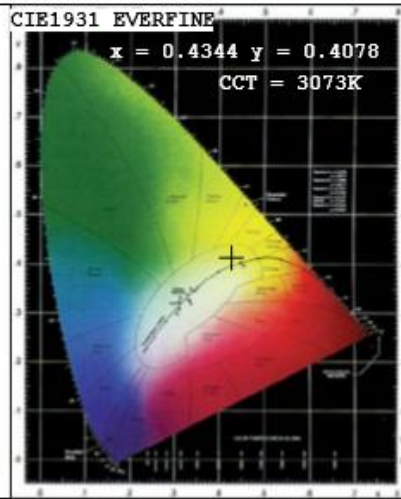
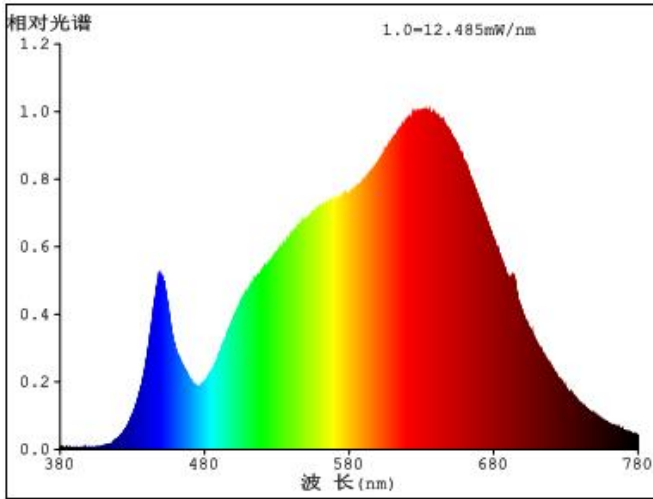

Lamp & Reflector

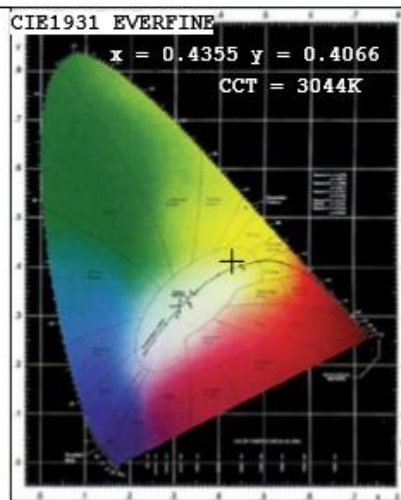
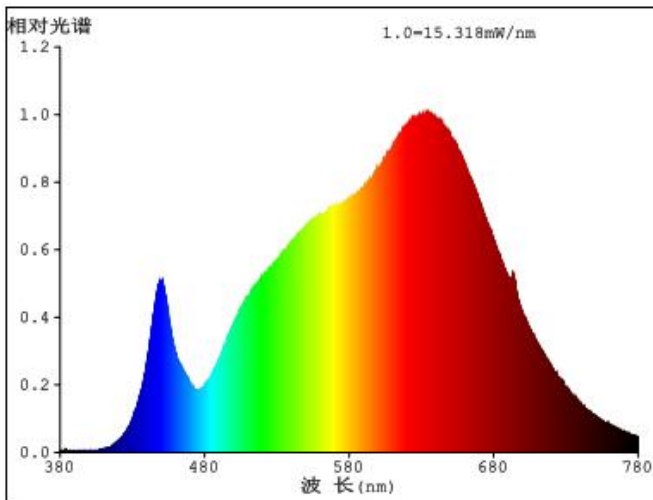

Light Source

RECESSED DOWNLIGHT

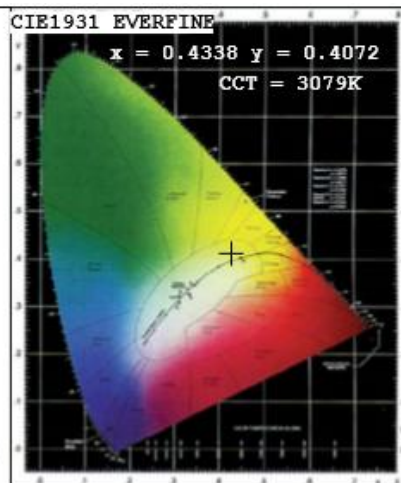
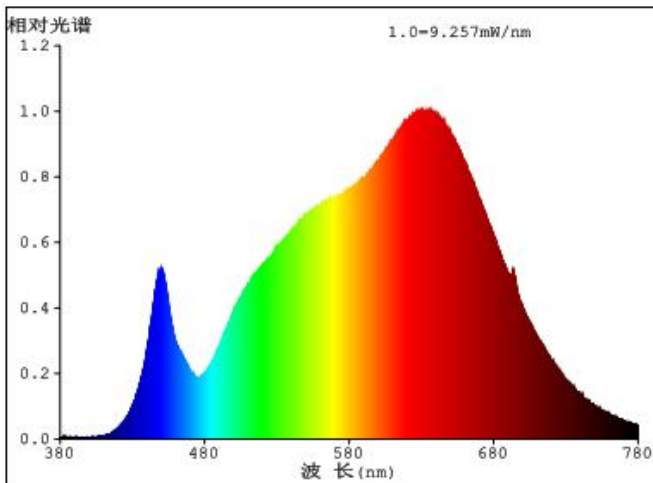

Whole Lamp

\*Other special requirements please confirm with our sales.



**Liteharbor Lighting Technology Co., Ltd.**  
 New Industry Area Hecun Danzao Town  
 Nanhai Foshan City Guangdong China

TEL: +86-757-8180 8687  
 FAX: +86-757-8180 8685  
 E-mail: info@liteharbor.com

Website: www.liteharbor.com  
 Specifications subject to change w/o notice  
 Revision: Sep. 2022

# INSTALLATION INSTRUCTION

ITEM NO.:A35-M-1

1. Read all instructions before installing.
2. System is intended for installation by a qualified electrician in accordance with the National Electrical Code and local regulations.
3. Go to the main fuse box, or circuit breaker. Place the main power switch in the “OFF” position and unscrew the fuse(s) or switch “OFF” the circuit breaker switch(es) that control the power to the fixture or room that you are working on.
4. Place the wall switch in the “OFF” position.

## NEW CONSTRUCTION HOUSING MOUNTING:

- 1). Install mounting frame using two hanger bars, (24 1/2” max).Bars are notched on the ends to fit over “T” bars in suspended ceilings.Hanger bars include a captive mounting “screw-nail” forease of installation (as Fig.1). Align the bottom of the hanger bar with the bottom of the wood joist. Secure the “screw-nail” on each end by screwdriver (as Fig.A), or by hammer (as Fig.B).
- 2). Slide fixture along bar hangers into desired location.Use locking screws to secure (as Fig.C).
- 3). Screw in the mud plate into the ceiling(Fig.3).
- 4). Connect the quick connector(Fig.4).
- 5). Push the LED engine into housing and rotate the fixed bracket 180 degree to fix the

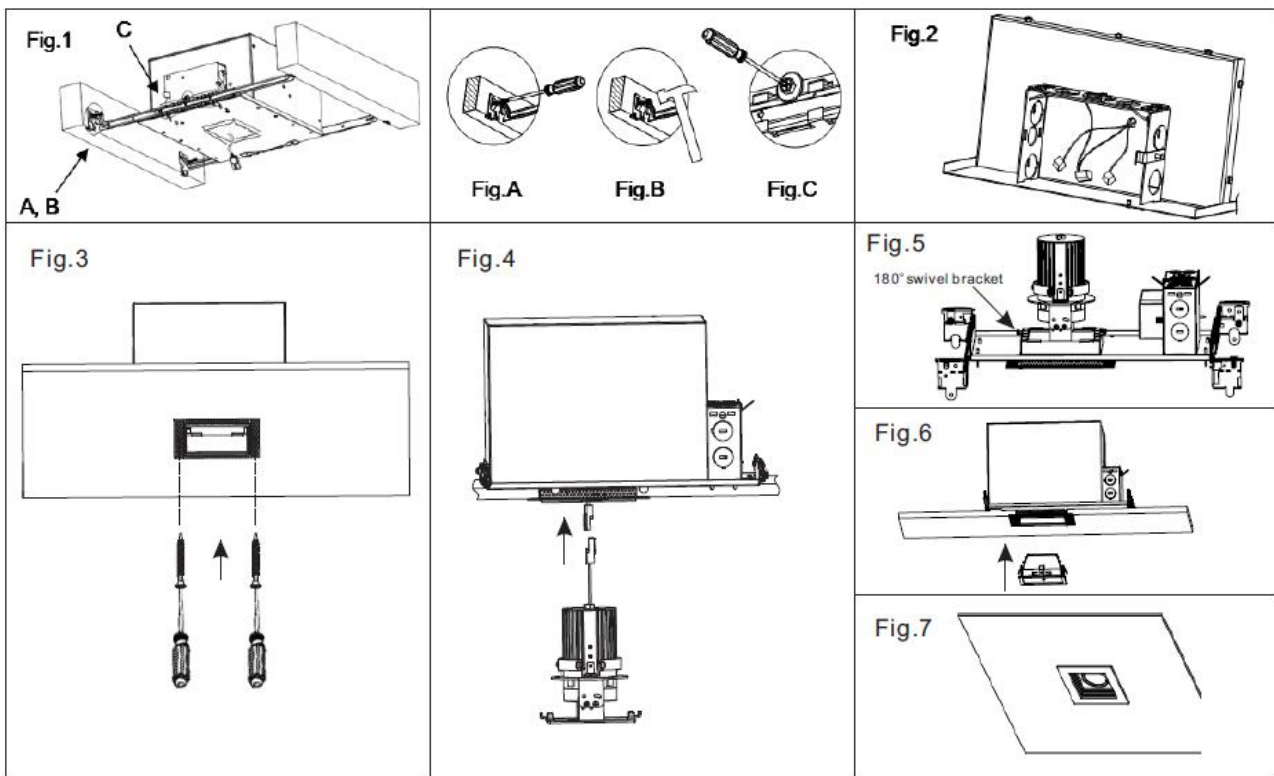

\*Other special requirements please confirm with our sales.



**Liteharbor Lighting Technology Co., Ltd.**  
New Industry Area Hecun Danzao Town  
Nanhai Foshan City Guangdong China

TEL: +86-757-8180 8687  
FAX: +86-757-8180 8685  
E-mail: info@liteharbor.com

Website: www.liteharbor.com  
Specifications subject to change w/o notice  
Revision: Sep. 2022



RECESSED DOWNLIGHT