

# AL4-FS

## POE Lighting 4" Architectural Square LED Recessed Downlight

Catalog #		Prepared by	LiteHarbor
Project		Date	
Notes			

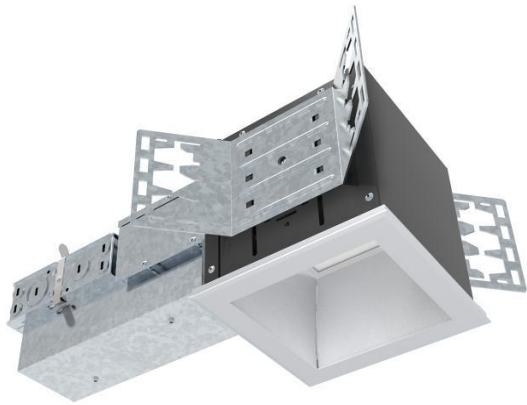









### DESCRIPTION

- Architectural LED luminaire, iron shell spray production, with anti-corrosion shell.
- Emergency system is available.
- LED light source using high quality, high lumen and high CRI LED bead.
- Square emitting surface, with uniform light distribution, high luminous efficiency.
- Energy saving, long lifespan even without maintain.
- New generation of cold light source, save power, excellent casting performance with far and high light casting compare to common fluorescent and energy saving lamp.

### APPLICATIONS

- Hospitality
- Hotels
- Offices
- Kitchens
- Indoor residential
- Shopping mall stores
- Villa
- Museum
- Commercial

Widely used for commercial and residential applications.

 ROUND/SQUARE	 TRIM/TRIMLESS	 IC NON-IC HOUSING TYPES	 ETL Certificate
 120° BEAM ANGLE	 2700K 3000K 3500K 4000K 5000K CCT	 82/92 LED CRI	 5 LED WARRANTY

\*Other special requirements please confirm with our sales.

### FEATURES

- PoE scheme or LED quick connector provided. .
- Robust, durable and lightweight.
- Power & CCT Tunable, convenient inventory and cost savings.
- No Flickering, noise or RF interference
- Easy to install to suspended ceiling grids.
- Up to 80lm/W, total 960lm to 2560lm delivered lumens (2700K-6000K) .
- 5 classic color temperatures tunable (2700K, 3000K, 3500K, 4000K, 5000K), RGB+Tunable White(2700K-6000K) and Tunable White (1800K-6000K) .
- Beam angle: 120°
- Available in trimmed or trimless.

### LAMPSHADE

- Aluminum fog reflective reflector, high light uniformity.
- With marbles design mode, the overall height of the size is controlled, smooth appearance, excellent visual effects.

### LISTING/WARRANTY

ETL listed to US and Canadian standards for damp location W/Feed through.

5 Year Limited Warranty.

### DIMENSINS

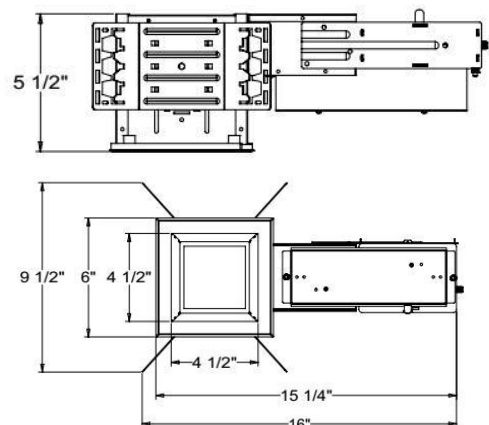

**Liteharbor Lighting Technology Co., Ltd.**  
New Industry Area Hecun Danzao Town  
Nanhai Foshan City Guangdong China

TEL: +86-757-8180 8687  
FAX: +86-757-8180 8685  
E-mail: info@liteharbor.com

Website: www.liteharbor.com  
Specifications subject to change w/o notice  
Revision: Sep. 2022

## LIGHT SOURCE \ RADIATOR

- High light transmittance, strong light diffusion performance, no shadow no glare.
- Point light source emitting turned into spherical light emitting.
- Milky white light transmission rate reach 90% above.
- Excellent concealed light source, achieve the best light transmission rate without seeing the LED lamp bead.
- Outstanding heat dissipation aluminum material, the temperature is guaranteed to be the touch temperature below.

## BEAM ANGLE

120 Degrees

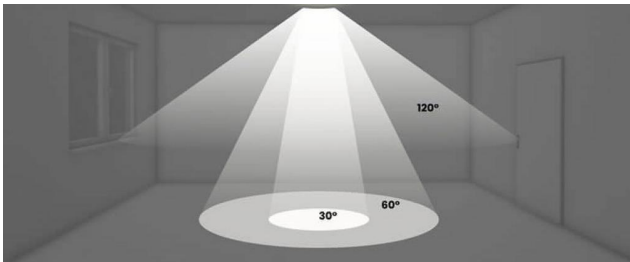

## LOCATING PART

- Locating part, easy for installation, will not cause abnormal phenomena such as deformation.
- Resolved the problem of product is not centered.

## POE SOLUTION

Liteharbor PoE solution with single/double ethernet interface “One in” or “One in One out” design. It provides RJ45 wiring system suitable for CAT5, CAT6, CAT7, CAT8 Ethernet Cable with UL listed. PoE technology sends 10/45 Gbps of data and 30W, 60W up to 90W of power budget to devices over Cat7 and Cat8 Ethernet cables for a maximum distance of 100m.



## SPECIFICATION

DESCRIPTION	AL4-FS-A			AL6-FS-A		
Wattage	12W	18	24	18W	24W	32W
Luminous Flux	960lm	1440lm	1920lm	1440lm	1920lm	2560
Lumens / Watt	80lm/w					
CRI	82+ / 92+					
Colour Temperature	2700K, 3000K, 3500K, 4000K, 5000K, 6000K /3CCT/5CCT					
Driver Input	DC 24V					
Dimming	Tunable White / Dim to Warm					
Optics	120°					
Location	Insulated Ceiling & Damp Locations					
Finish	White, Black, Satin Nickel					
Working Humidity	10% – 70%					
IP Rating	20					
UGR	<18					
THD	<20%					
Installation	Recessed Mounted					
Lifespan	50,000 Hours at 70% Light Output					
Executive Standard	ETL					
Warranty	5 Year Limited					

\*Other special requirements please confirm with our sales.



**Liteharbor Lighting Technology Co., Ltd.**

New Industry Area Hecun Danzao Town  
Nanhai Foshan City Guangdong China

TEL: +86-757-8180 8687

FAX: +86-757-8180 8685

E-mail: info@liteharbor.com

Website: www.liteharbor.com

Specifications subject to change w/o notice

Revision: Sep. 2022

**Order Matrix** | Example: AL4-FS

**A B C D E F G H I J**  
**K L**

**Item No.:AL4-SF/AL6-SF**

A	Series	D	IC Rated Type	B	Aperture Opening	E	Trim
AL4-FS	4" Architectural Downlight	IC	IC	S	Square	TD	Trimmed
AL6-FS	6" Architectural Downlight	IA	IC Airtight			TL	Trimless

C	Functions	J	Beam Angle	F	Install	L	Dimmable
	Vertical Downlight	120°	120° floodlight		General Bar Hanger	TW	Tunable White
				C	C-channel Bar Hanger	DW	Dim to Warm

I	Wattage/Lumen	G	Finish	H	LED Available
L12	LED 12W/960 Lumen	WH	White	CREE	CREE
L18	LED 18W/1440 Lumen	BK	Black	Citizen	Citizen
L24	LED 24W/1920 Lumen	SN	Satin Nickel	Epistar	Epistar
L32	LED 32W/2560 Lumen			Seoul	Seoul
				Osram	Osram

K	Color Temperature
27K	2700K
30K	3000K
35K	3500K
40K	4000K
50K	5000K
60K	6000K
3C	3CCT(3000K,4000K,5000K)
5C	5CCT(2700K,3000K,3500K,4000K,5000K)



ARCHITECTURAL DOWNLIGHT

\*Other special requirements please confirm with our sales.

 <p><b>Liteharbor Lighting Technology Co., Ltd.</b> New Industry Area Hecun Danzao Town Nanhai Foshan City Guangdong China</p>	TEL: +86-757-8180 8687 FAX: +86-757-8180 8685 E-mail: info@liteharbor.com	Website: www.liteharbor.com Specifications subject to change w/o notice Revision: Sep. 2022

## TOP POE BENEFITS INCLUDE

- ◆ Further Cost Savings
- ◆ Easy, Low-Voltage Installation
- ◆ Helps future-proof buildings
- ◆ Enhanced Flexibility and Control
- ◆ Enables software control integration
- ◆ Social Benefits
- ◆ Robust, Secure and Reliable

## ADVANTAGES OF POE

The primary advantage of power over ethernet is the delivery of data and power over one Cat5 or Cat6 ethernet cable.

Remote installation generally costs less than optical fiber and does not require a qualified electrician, saving building owners valuable time and labor costs.

One of the biggest advantages of PoE technology is cost savings.

PoE installation is cheaper than traditional electrical work, operating costs are lower over the course of the PoE lifetime and data can inform further decisions to save costs — all without sacrificing lighting quality for occupants.

## POWER OVER ETHERNET LIGHTING

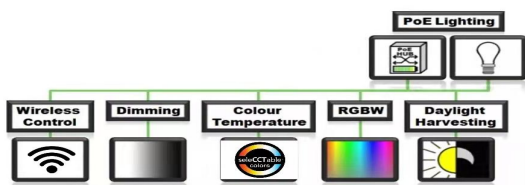

## POE SOLUTION

The wiring diagram

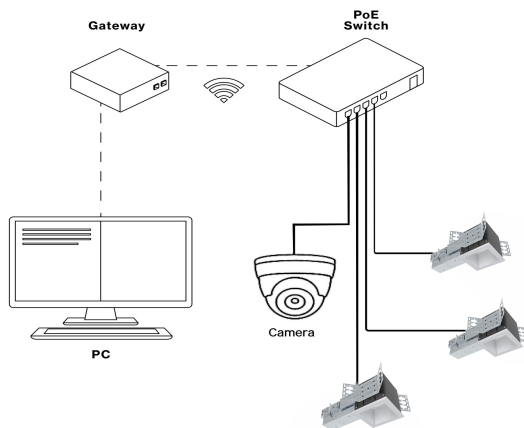

\*Other special requirements please confirm with our sales.

## WHY USE POE LIGHTING

PoE lighting reduces power, material, labor and maintenance.



70% Cost Saving

