

# BL4-301A-CFR 4" Fire Rated LED Slim Panel Light

Catalog #		Prepared by	LiteHarbor
Project		Date	
Notes			



## FEATURES

- PoE scheme or LED quick connector provided.
- Available in all 4" round openings.
- Retrofit or New Construction.
- 1/2" Thin - Install Directly Under Joists, Maximum Layout Flexibility.
- Comes with Junction Box & Driver, No Housing Required.
- Robust, durable and lightweight.
- 3CCT range changeable, 3000K, 4000K and 5000K, convenient inventory and cost savings.
- No Flickering, noise or RF interference
- Easy to install to suspended ceiling grids
- No UV, IR or Mercury
- Anti-glare

## DESCRIPTION

Liteharbor Mars Light series with 2 Hour Fire Resistance to meet and exceed strict fire safety codes with only 1/2" clearance, this ultra thin recessed LED Panel is absolutely perfect for tight spaces, soffits and insulated and dropped ceilings. This LED is 9 watts and replaces a 45 watt halogen. Save up to 80% energy for same light output. The thin Panel profile with spring clips allows for quick and easy installation. Ideal for confined spaces and suitable for damp locations.

## MOUNTING

Cut hole in ceiling and snap fixture in opening with attached spring clips. 2" above ceiling clearance required for driver.









## APPLICATIONS

- hospitality
- Retail
- Kitchens
- hotels
- Museum
- indoor / outdoor residential,
- offices
- Commercial
- shopping mall stores

## LISTING/WARRANTY

- ETL to US and Canadian standards for damp location W/Feed through.
- 3 Year Limited Warranty.

\*Other special requirements please confirm with our sales.

	<b>2 hour fire rated</b>		<b>Damp Location</b>
	<b>Color Temperature</b>		<b>Dim To Warm</b>
	<b>IC Rated</b>		<b>Airtight</b>
	<b>3 Year Limited Warranty</b>		<b>ETL Certificate</b>

## POE SOLUTION

Liteharbor PoE solution with single/double ethernet interface "One in" or "One in One out" design. It provides RJ45 wiring system suitable for CAT5, CAT6, CAT7, CAT8 Ethernet Cable with UL listed. PoE technology sends 10/45 Gbps of data and 30W, 60W up to 90W of power budget to devices over Cat7 and Cat8 Ethernet cables for a maximum distance of 100m.

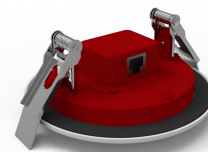

**Liteharbor Lighting Technology Co., Ltd.**  
New Industry Area Hecun Danzao Town  
Nanhai Foshan City Guangdong China

TEL: +86-757-8180 8675  
FAX: +86-757-8180 8685  
E-mail: info@liteharbor.com

Website: www.liteharbor.com  
Specifications subject to change w/o notice  
Revision: May. 2022

PANEL LIGHT

## SPECIFICATION

DESCRIPTION	BL4-301A-CFR	BL4-301B-CFR	BL4-301-CFR
Wattage	9W		9W
Luminosity	900lm		900lm
Luminous Flux	700lm		700lm
Lumens / Watt	100lm/w		100lm/w
CRI	90+		90+
Colour Temperature	3000K, 4000K, 6500K/3CCT(3000K-4000K-5000K)		3000K, 4000K, 6500K/3CCT(3000K-4000K-5000K)
Driver Input	24V		120V AC or 120V-277V AC 50/60 Hz
Power Factor	-		0.98
Dimming	RGB+W / Tunable White		TRIAC Dimmers 10%-100% (120V only)
Location	Insulated Ceiling & Damp Locations		Insulated Ceiling & Damp Locations
Finish	White,Black,Satin Nickel		White,Black,Satin Nickel
Dimensions	∅ 4.72"* H 1.10"		∅ 4.72"* H 0.35"
Wire	Cat5/Cat6		FT4/FT6
Working Temperature	-20°C to +60°C		-20°C to +60°C
Working Humidity	10% – 70%		10% – 70%
IP Rating	20		20
Input Current	-		0.7A
Output Current	-		360mA
Power Efficiency	>90%		>90%
UGR	<18		<18
Beam Angle	120°		120°
THD	<20%		<20%
Installation	Recessed Ceiling Mount		Recessed Ceiling Mount
Lifespan	50,000 Hours at 70% Light Output		50,000 Hours at 70% Light Output
Executive Standard	ETL/ENERGY STAR		ETL/ENERGY STAR
Warranty	3 Year Limited for Fixture & Driver		3 Year Limited for Fixture & Driver



PANEL LIGHT

## DIMENSINS

Ceiling cut out: 4"

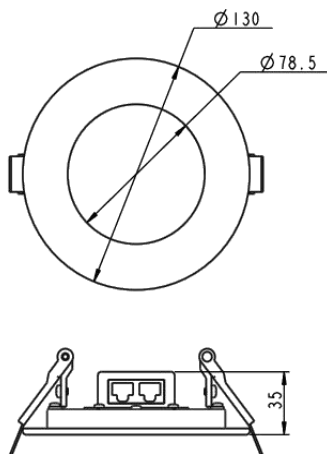

## POE SOLUTION

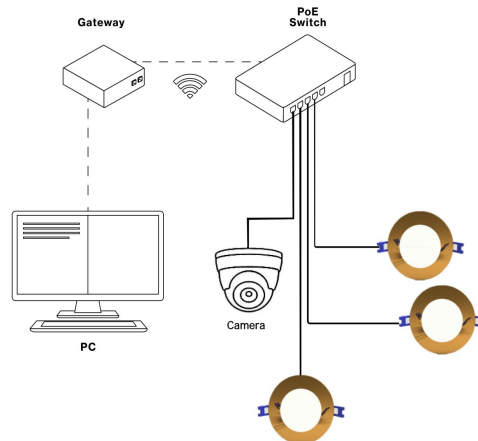

\*Other special requirements please confirm with our sales.



**Liteharbor Lighting Technology Co., Ltd.**  
 New Industry Area Hecun Danzao Town  
 Nanhai Foshan City Guangdong China

TEL: +86-757-8180 8675  
 FAX: +86-757-8180 8685  
 E-mail: info@liteharbor.com

Website: www.liteharbor.com  
 Specifications subject to change w/o notice  
 Revision: May, 2022

## COLOR TEMPERATURE

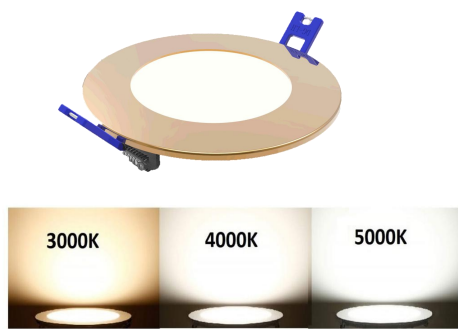

Three Colors in One Light



Handheld remote controller

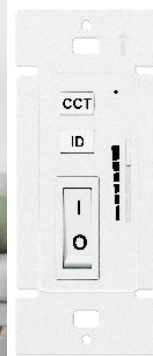

Wall typeremote controller

## MARS LIGHT SERIES

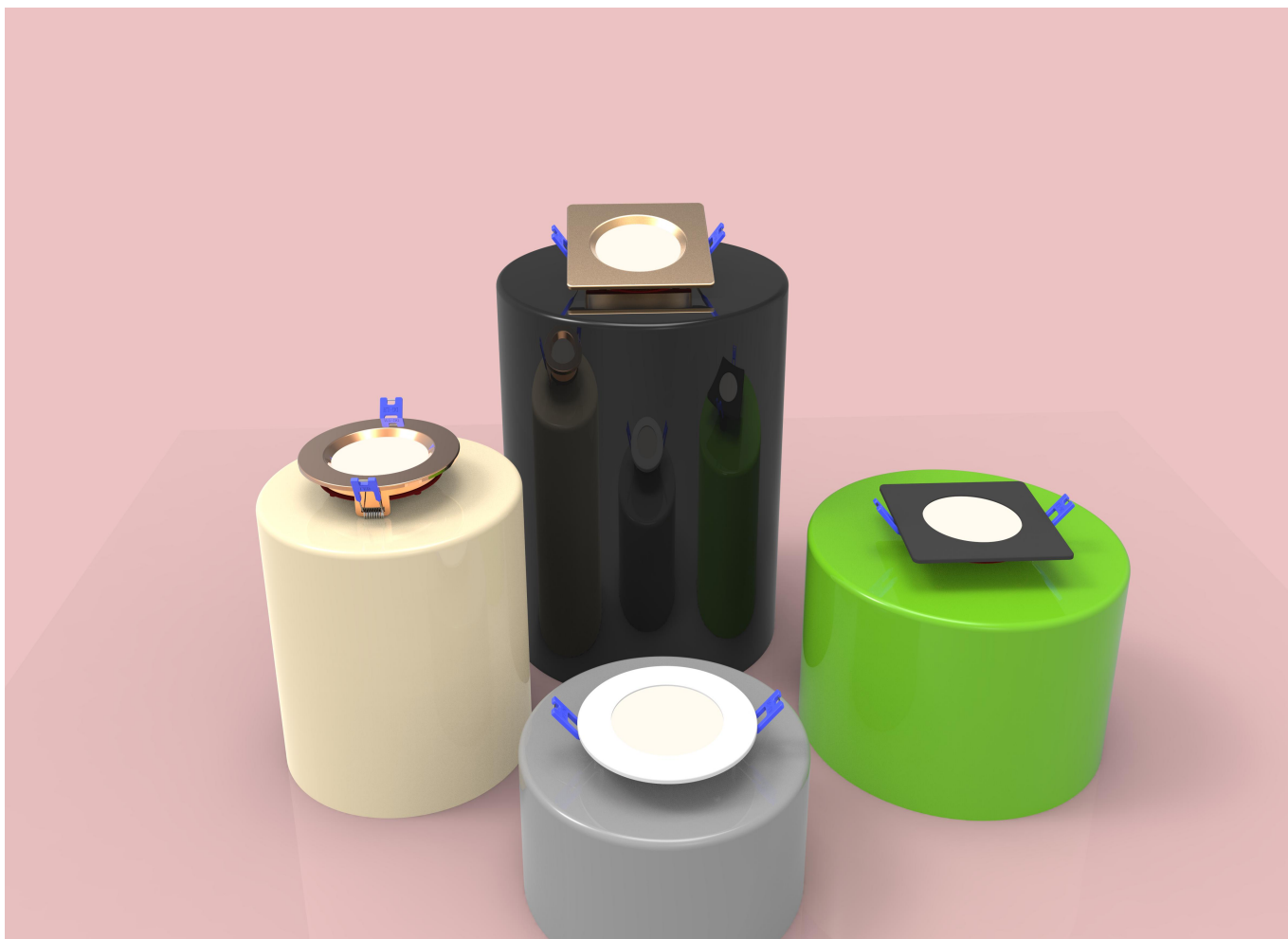

PANEL LIGHT

\*Other special requirements please confirm with our sales.



**Liteharbor Lighting Technology Co., Ltd.**

New Industry Area Hecun Danzao Town  
Nanhai Foshan City Guangdong China

TEL: +86-757-8180 8675

FAX: +86-757-8180 8685

E-mail: [info@liteharbor.com](mailto:info@liteharbor.com)

Website: [www.liteharbor.com](http://www.liteharbor.com)

Specifications subject to change w/o notice

Revision: May. 2022

## BLX-301X-F SERIES

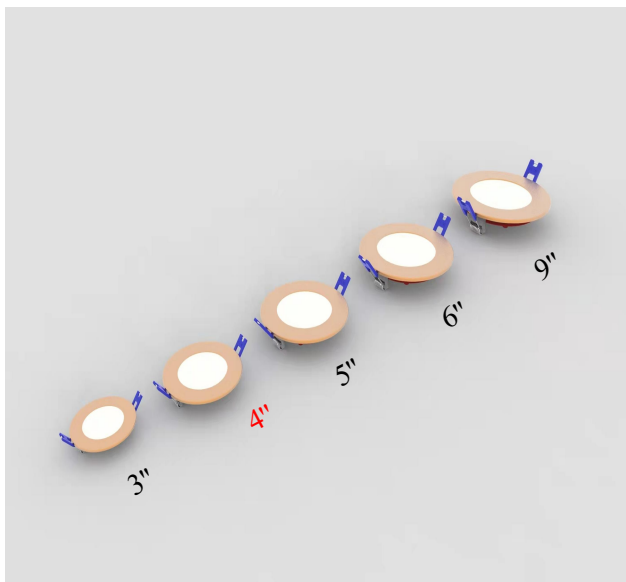

Other size coming soon

Item	Description	Lumen
BL3-301-CFR	120V/120V-277V, Triac/0-10V Dim, 6W MAX	460lm
BL3-301A-CFR	POE Single connection hole 24V, 6W MAX	460lm
BL3-301B-CFR	POE Double connection hole 24V, 6W MAX	460lm
BL4-301-CFR	120V/120V-277V, Triac/0-10V Dim, 9W MAX	700lm
BL4-301A-CFR	POE Single connection hole 24V, 9W MAX	700lm
BL4-301B-CFR	POE Double connection hole 24V, 9W MAX	700lm
BL5-301-CFR	120V/120V-277V, Triac/0-10V Dim, 12W MAX	930lm
BL5-301A-CFR	POE Single connection hole 24V, 12W MAX	930lm
BL5-301B-CFR	POE Double connection hole 24V, 12W MAX	930lm
BL6-301-CFR	120V/120V-277V, Triac/0-10V Dim, 14W MAX	1080lm
BL6-301A-CFR	POE Single connection hole 24V, 14W MAX	1080lm
BL6-301B-CFR	POE Double connection hole 24V, 14W MAX	1080lm
BL9-301-CFR	120V/120V-277V, Triac/0-10V Dim, 20W MAX	1500lm
BL9-301A-CFR	POE Single connection hole 24V, 20W MAX	1500lm
BL9-301B-CFR	POE Double connection hole 24V, 20W MAX	1500lm

## ORDERING GUIDE

Mars light Series	Mounting	Wattage	Color Temperature
<input type="checkbox"/> BL4-301-CFR	<input type="checkbox"/> R   Remodel	<input type="checkbox"/> 6   6W/lamp	<input type="checkbox"/> 30K   3000K
<input type="checkbox"/> BL4-301A-CFR	<input type="checkbox"/> NC   New Construction	<input type="checkbox"/> 9   9W/lamp	<input type="checkbox"/> 40K   4000K
<input type="checkbox"/> BL4-301B-CFR		<input type="checkbox"/> 12   12W/lamp	<input type="checkbox"/> 50K   5000K
		<input type="checkbox"/> 14   14W/lamp	<input type="checkbox"/> 65K   6500K
		<input type="checkbox"/> 20   20W/lamp	<input type="checkbox"/> DW   Dim to Warm
			<input type="checkbox"/> TW   Tunable White

Input Voltage	Dimmable	Luminous Flux	Finish
<input type="checkbox"/> 120   120V	<input type="checkbox"/> Triac   Triac dimming	<input type="checkbox"/> 460lm	<input type="checkbox"/> WH   White
<input type="checkbox"/> U   120V-277V	<input type="checkbox"/> 0-10V   0-10V dimming	<input type="checkbox"/> 700lm	<input type="checkbox"/> BK   Black
<input type="checkbox"/> PoE   24V (PoE Scheme)		<input type="checkbox"/> 930lm	<input type="checkbox"/> SN   Satin Nickel
		<input type="checkbox"/> 1080lm	
		<input type="checkbox"/> 1500lm	

Cable	CRI	Light Source	Install Accessories
<input type="checkbox"/> C4   FT4	<input type="checkbox"/> 90   90+	<input type="checkbox"/> CREE	<input type="checkbox"/> Ceiling Tapper
<input type="checkbox"/> C6   FT6		<input type="checkbox"/> Citizen	<input type="checkbox"/> Ethernet Cable
<input type="checkbox"/> CT5   Cat5		<input type="checkbox"/> Epistar	<input type="checkbox"/> RJ45 Connectors
<input type="checkbox"/> CT6   Cat8		<input type="checkbox"/> Seoul	<input type="checkbox"/> RJ45 Crimp Tool Kit
		<input type="checkbox"/> Osram	

\*Other special requirements please confirm with our sales.



**Liteharbor Lighting Technology Co., Ltd.**

New Industry Area Hecun Danzao Town  
Nanhai Foshan City Guangdong China

TEL: +86-757-8180 8675

FAX: +86-757-8180 8685

E-mail: info@liteharbor.com

Website: www.liteharbor.com

Specifications subject to change w/o notice

Revision: May. 2022



## INSTALL ACCESSORIES

### Ethernet Cables Reference



Attribute	Cat 6	Cat 7	Cat 8
Frequency	250 MHz	600MHz	2000MHz
Transmission speed	1Gbps/10 Gbps	10 Gbps	25 Gbps/40 Gbps
Distance	100m	100m	30m
Number of Connectors in	4	4	2
Cable Construction	UTP or Shielded	Shielded	Shielded
Connector Type	RJ45	RJ45	RJ45
AWG	24 AWG	30 AWG	26AWG

### RJ45 Connectors

Modular plug clear plastic easy to DIY ethernet cable when you need.

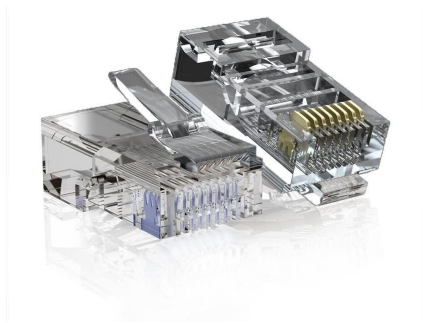

### Ceiling Tapper

Patented circular tooth tapper, Simple operation, the ceiling cut hole quickly.

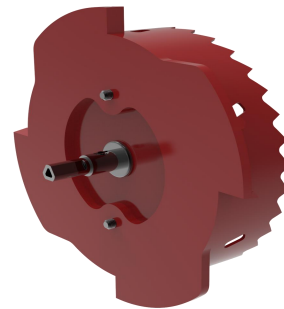

### Crimp Tool Kit

All-in-one RJ11/RJ12/RJ45 Modular Tool, Pass-Through Wire Stripper Cutter Crimper for Cat5/5e Cat6/6a Cat7 Cat8 Modular Plugs Connectors with Dovetail Clip.

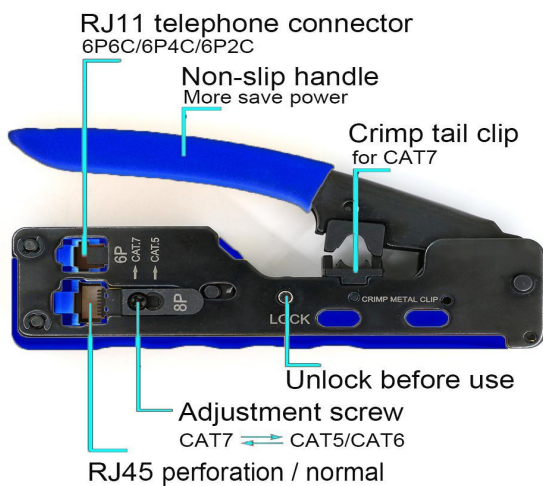

### Ethernet Cables

Cat 6/Cat 7/Cat 8 for option.



### PoE Switch

Not supplied by Liteharbor.



\*Other special requirements please contact with our sales.



**Liteharbor Lighting Technology Co., Ltd.**

New Industry Area Hecun Danzao Town  
Nanhai Foshan City Guangdong China

TEL: +86-757-8180 8687

FAX: +86-757-8180 8685

E-mail: [info@liteharbor.com](mailto:info@liteharbor.com)

Website: [www.liteharbor.com](http://www.liteharbor.com)

Specifications subject to change w/o notice

Revision: May. 2022



## BLX-301A-CFR INSTALLATION INSTRUCTIONS

1. Determine the location for installation and cut ceiling hole in accordance with cut-hole dimensions. Refer to *Hole Diameter* table for appropriate sizes. (Fig. 1)

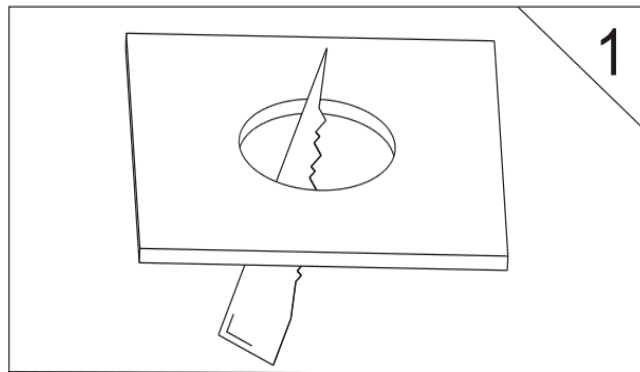

ROUND	Hole Size	SQUARE	Hole Size
Φ4.25"	4"	.25"*4.25	4"*4"

2. Run Ethernet cable from the rack to the fixture location and insert the fixture.(Fig. 2)

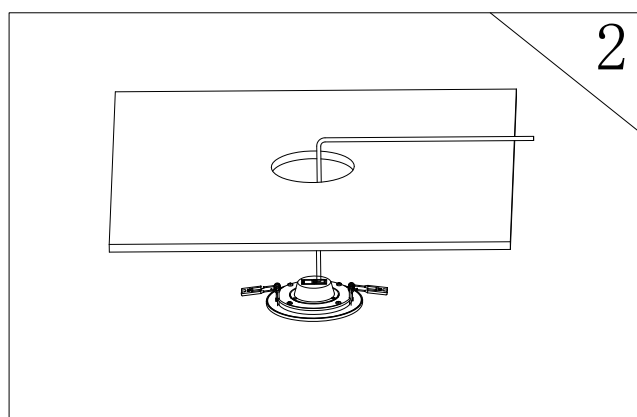

\*Other special requirements please contact with our sales.



**Liteharbor Lighting Technology Co., Ltd.**

New Industry Area Hecun Danzao Town

Nanhai Foshan City Guangdong China

TEL: +86-757-8180 8675

FAX: +86-757-8180 8685

E-mail: [info@liteharbor.com](mailto:info@liteharbor.com)

Website: [www.liteharbor.com](http://www.liteharbor.com)

Specifications subject to change w/o notice

Revision: May. 2022