



PROFESSIONAL IN LIGHTING
MANUFACTURING
SINCE 2006



A Liteharbor Lighting Technology Co., Ltd(Factory A)

Liteharbor Lighting Technology Co., Ltd was founded in 2006, Its predecessor is Yalle Lighting, We are a manufacturer with 15-year experiences in designing, developing and supplying wide selections of lighting products.

Liteharbor factory covers an area of 2,6000m2 , There are hardware factory, mold factory, carton factory, assembly plant and LED factory and many other factories, and all those factory are well-equipped.

LiteharborLighting offers 38 product Series, 3000 varieties of products (Mirror Light, Exit& Emergency Light, Recessed Downlight, LED Retrofit Downlight, Multiple Downlight, Ceiling Light, Track Light ,LED Linear Light, and a lot kinds of outdoor lights). All Liteharbor products are strictly conforming to international standards. Liteharborobtained over 200 international and domestic certification(cULus, cETLus, Energy Star, DLC, CE, RoHS). We add 30 new product patents annually. At present, we have acquired the ISO9001 International Quality System Certificate.We have been awarded "national high-tech enterprise", "green lighting enterprise", "enterprise technology center", etc.

www.liteharbor.com

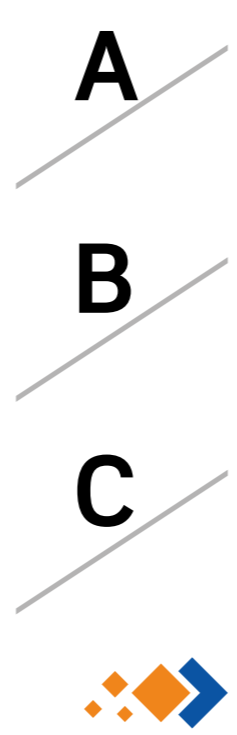

B Liteharbor Lighting marketing & sales headquarter

Liteharbor products are mainly exported to developed countries such as the US and Canada, 14 years accumulated a wealth of products in developed countries and industry experience, and in June 2011, We have established a domestic and Eurasian marketing center to undertake highend lighting projects, lighting projects and lighting solutions.

14 years, we have been committed to providing customers with professional, leading high-quality lighting products and quality, excellent efficient service.

C Liteharbor Lighting college of commerce

Liteharbor Business School is invested in December 25, 2015, Founded by Liteharbor lighting technology co., LTD. In the initial stage, there were 16 internal lecturers. Course contents include the marketing, e-commerce, network operations, business skills, enterprise culture, enterprise management, lighting and photovoltaic and other professional knowledge and experience to share content.

Liteharbor Business School is multifaceted create a learning environment and atmosphere, let more enterprise staff here can rapid growth, so that the business school has become the effective brand incubator company.

The Year of 2006



In May, Yalic Lighting (Nanhai Hardware Products Co., Ltd.) was founded. (Liteharbor's predecessor)

In June, Authorized by cULus cETLus

In August, The plant has been moved, the area expanded to 3500 square meters

Establishment of Sino-US Joint Venture Company

The Year of 2009



In June, Liteharbor Lighting Technology Co., Ltd was founded.

In June, Became a PHILIPS OEM channel business

In June, Became an OSRAM OEM channel business

In September, Establishment of marketing center

In October, win the bidding of the Project of the United States Consulate in Guangzhou.

The Year of 2010



In January, ERP management software was introduced

In February, Newly added 8600 square meter plant

Became a supplier and partner of Thomas & Betts

Establishment of LED Workshop

Establishment of Plant Growth Lamp Workshop

The Year of 2011



In April, LITEHARBOR brand was registered in North America, Hongkong and China

In May, Became director of Foshan Lighting Association

In July, integrated hardware factory, powder coating factory, spinning factory, mold factory

The Year of 2012



In March, Established Hong Kong (Hongkong) International Company

In December, established packaging and printing Factory

The Project of the United States Consulate in Guangzhou completed

Won the lighting project of Chengdu Qingyang Square

The Year of 2013



In May, Passed the ISO9001:2008 international standard quality management system certification

In September, Founded Foshan network business association, Liteharbor became executive chairman of the unit

In September, win the bidding of Beichen lighting project.

In September, Became BRIDGELUX channel business

In November, win the bidding of tide courtyard lighting project

The Year of 2014



In March, established Guangdong Intance Energy Technology Co Ltd

In June, win the bidding of the Qingyang Plaza lighting project

In July, the warehouse and office were rebuilt

In August, recognized as Nanhai green lighting enterprises

The Year of 2015



In April, win the bidding of the U.S. Embassy in Beijing lighting engineering projects

In May, became the world's top 500 well-known brands lighting products and solutions provider

In August, won the lighting project of Li Zhuang

In October, certified 22 cULus/cETLus/CE/CCC/TUV/CQC and obtained 11 patents.

The Year of 2016



The title of "Guangdong high-tech enterprise" was recognized

Identification of "provincial enterprise technology center"

Won the Top 12 of Alibaba New Foreign Trade Competition and won the Best Popularity Award

The Year of 2017



The name of "private technology enterprise in Guangdong province" organized by the Guangdong science and Technology Department

Obtain the title of "quality brand enterprise" issued by ten ministries and commissions

Selected "top 100 enterprises of LED lighting applications in China" selection"

Won the "2017 China lighting industry's ten major commercial lighting brand" title

Selected as "China's top 100 LED lighting applications and Top 100 lighting project" title

The Year of 2018



Won "Guangdong LED benchmarking enterprise"

Won the title of "2018 China Top 10 LED lighting brand"

Newly established die-cast branch company

Won the high tech LED Golden Globe award"

Billy was appointed as the 6th General Manager of Liteharbor

Newly established LED lighted Mirror branch company

Awarded "top ten real estate company a-class supplier" honor

Won "professionality, delicacy, specialty, novelty" enterprise of Foshan

The Year of 2019



Establishment of Indonesian factory

Became a supplier and partner of Rexel

Obtain "annual China Top 10 LED lighting application enterprises" title

Establishment of Vietnam factory

In June, Upgrade ISO9001:2008 to ISO9001:2015 International Standard Quality Management System Certification

Establishment of Cambodia factory

The Year of 2020



Future

COMPANY DEVELOPMENT History

Liteharbor Harbor of Light!

CORPORATE CULTURE

Liteharbor declaration:

I love myself, I will always cherish a warm, thanksgiving, kind and tolerant heart. Sincere treatment with my colleagues, rain and wind, and go beyond self! I will rely on my wisdom and efforts, the immediate work to the utmost, and speak with results! In my life, I must do it, no corruption, no waste, no abuse of power! I must do: no manufacturing, no passing and no accepting bad products, I must do: knowing the truth, the real, do practical work, seek practical results; I must: reduce the cost, improve efficiency, obey management, obey the rules, keep the secret! I take Liteharbor as my home, and Liteharbor is proud of me. I am an excellent Liteharbor family member.

Mission:

To provide advanced and scientific lighting technology and light environment

Vision:

Where there is a need of lighting, where there is Liteharbor

Value:

The customer is supreme, action, innovation, unity and progress, integrity



Open office environment



Liteharbor Business School Start Ceremony



“Mo Hai Shu Xiang” Reading Month Start Meeting



Liteharbor Lighting was invited to participate in China (Guangdong) - Canada (Great Britain, Columbia) economic and trade cooperation and exchange meeting

On May 9, 2016, chairman Billy Liang was invited to attend the China (Guangdong) - Canada (British Columbia) (BC) economic and trade cooperation conference, and posed for pictures with all business and political parties. The exchange was held at the Vancouver Convention and Exhibition center. Political, commercial, academic and media circles, more than 500 people attended.



Address by Secretary of the CPC Guangdong Provincial Committee (ChunhuaHu)



Liteharbor Lighting's enterprise representatives participated in the cooperation and communication meeting



Foshan network operators association inaugural meeting - Executive Chairman (Billy Liang) speech

Foshan network business association is a non-profit organization initiated by members. It was established in November 11, 2013. Since its establishment, the chamber of Commerce has 300 member enterprises, more than 60 members of the Council, the total output value of 10 billion yuan. Chamber of commerce is committed to the rapid growth of member enterprises, to promote complementary advantages among members of enterprises, win-win cooperation, and strengthen relations between members, enterprises and government.

As the Foshan municipal network Liteharbor Lighting Association executive president at the beginning of the "unit", chairman Billy Liang served as executive president of association, we witnessed the growth of the association and the association, together to share a total growth!



Big love activities to help poor families



Liteharbor won the Foshan network operators association "executive chairman unit"



Liteharbor Lighting was invited to participate in the press conference of Foshan e-commerce Expo

2014 Chinese (Foshan) international e-commerce Expo in November 28 - 29 at the Foshan International Conference and Exhibition Center, through the online platform, service providers to demonstrate experience offline mode O2O, enterprise or business owners can make more in-depth understanding of e-commerce, e-commerce for enterprises is not difficult to do. The Expo aims to build an effective communication platform for platform providers, service providers and traditional enterprises. As a leader in the electricity supplier industry, Liteharbor has actively organized and participated in the exposition. Liteharbor has confidence that it can develop further and further on the road of e-commerce in the future



Foshan e-commerce Expo site



Liteharbor Team won the championship at the Alibaba foreign trade horse race"



Visit remote mountain village Hope Primary School

in the development of enterprise at the same time, Liteharbor lighting help charityfor many years, chairman Billy Liang repeatedly visited a remote village hope primary school to bring the team, take up supplies for the children in poor mountainous areas; and in the holiday day, lead the team go to the orphanage to visit the elderly, send them warmth and love; in the Wenchuan earthquake and Ludian earthquake, is donated more than 1 million of the goods, In the future, Liteharborlighting will continue to give charity, stick to it, to help more people who need help.



Accompany the welfare of the elderly for Christmas



Liteharbor Team offer love to the afflicted compatriots in Ludian



Integrating sphere test room

Fully meet the various photochromic performance test and analysis of related test sources, spectral power distribution, measurement of LED chromaticity coordinates, color temperature, color rendering index, color difference, peak wavelength, spectral half width, dominant wavelength, color purity, luminous flux, luminous intensity, luminous efficiency, forward voltage, reverse leakage current etc. light electric performance parameters; fully meet the CIE measurement of light and color requirements.



Color difference test



Salt spray test



Testing of electrical parameters of products at different voltages



Temperature rise test



Lamps assembly workshop

Hardware Factory | Mold Factory | Carton Factory | Assembly Plant | Led Factory
 Liteharbor lighting assembly workshop set up 6 assembly lines, strictly abide by the ISO9001 quality management measures management operations, mainly assembled lamps, finished products and product packaging, but also set up a finished product inspection workshop. This scale of production provides a solid backing for our capacity assurance, quality control, high efficiency, low consumption and cost control.



Laser Cutting Machine



Numerical Control Press Machine



Horizontal Cold Pressure Chamber Die Casting Machine

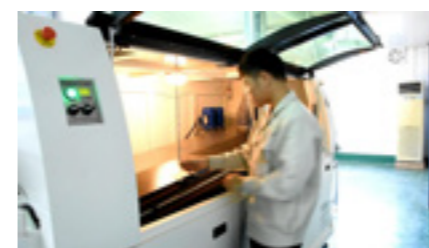

Full-Automatic Energy Saving Wave Soldering Equipment



Laser Marking Machine



Intelligent Monitoring Type Power Aging Test Equipment

GLOBAL STRATEGIC PARTNER FOR LITEHARBOR LIGHTING

www.liteharbor.com

CREATING GREEN FOR ENVIRONMENT
AND CREATING
VALUE FOR CUSTOMERS



OSRAM



PHILIPS



3M Science



LEDIA Lighting



CIMC



LITEHARBOR



LESSO



SYLVANIA



THORN



MEAN WELL



OPPLE



IDEAL



NVC

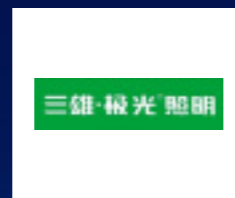

PAK



HUAYI LIGHTING



KINGSUN



TCL



LUMILEDS



CREE



EPISTAR

PROJECT LIGHTING SOLUTION

Liteharbor Harbor of Light!

THE QUALIFICATION Of The Enterprise

Over the past 12 years, Liteharbor has made gratifying achievements, both of which are the crystallization of the wisdom and actions of the people of Liteharbor, all of which are designed to enable customers to enjoy better and more advanced products and services.

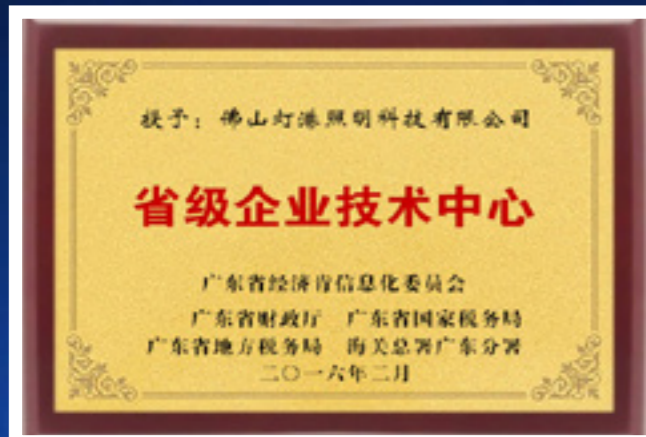
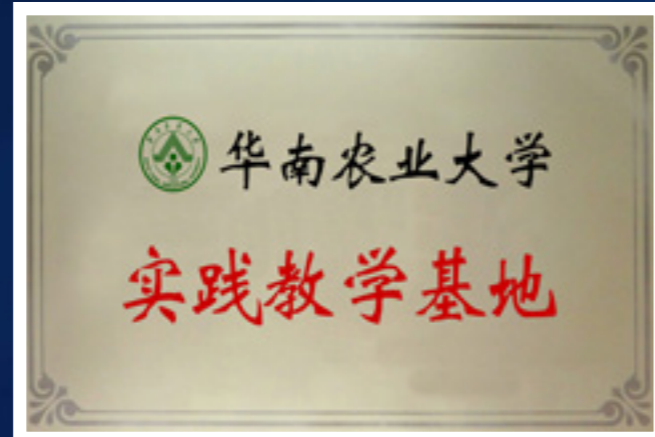



26

X-LIGHT SERIES LED MINI SPOTLIGHT

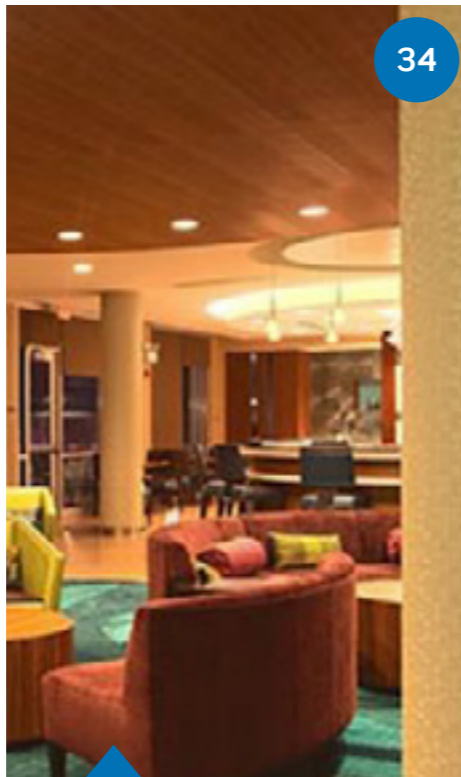

34

COB LED RECESSED DOWNLIGHT



54

COMMERCIAL DOWNLIGHT



96

RESIDENTIAL MULTIPLE DOWNLIGHT

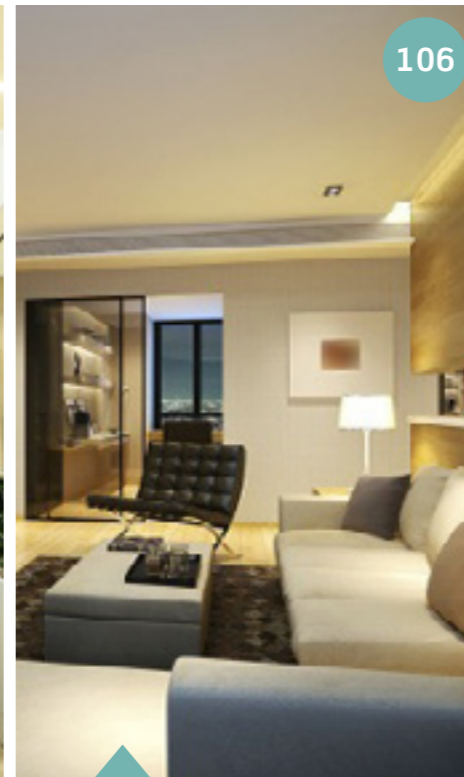

106

COMMERCIAL MULTIPLE DOWNLIGHT



124

MINI LED MULTIPLE DOWNLIGHT



60

ARCHITECTURAL DOWNLIGHT

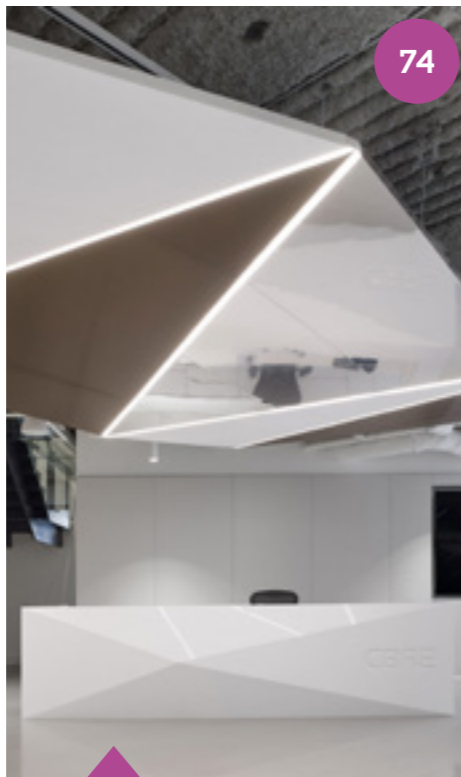

74

CYLINDERS PENDANT LED DOWNLIGHT



80

SURFACE MOUNTED LED DOWNLIGHT



139

LED WIRELESS SPEAKER LIGHT

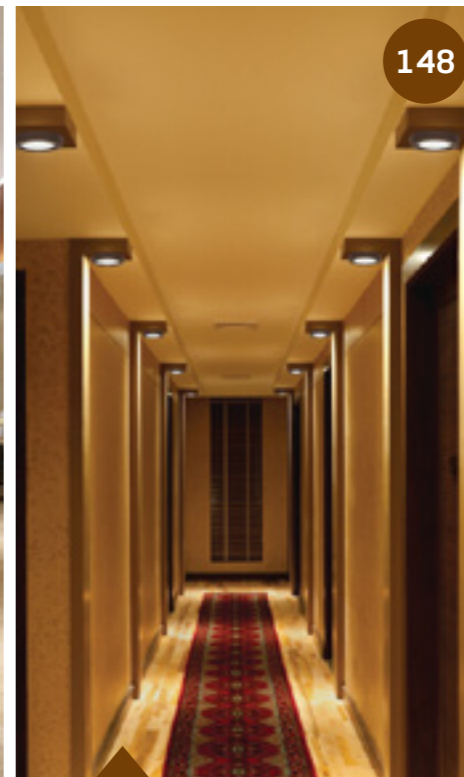

148

LED CEILING FIXTURES



167

LED PENDANT LIGHT



LED TRACK LIGHT

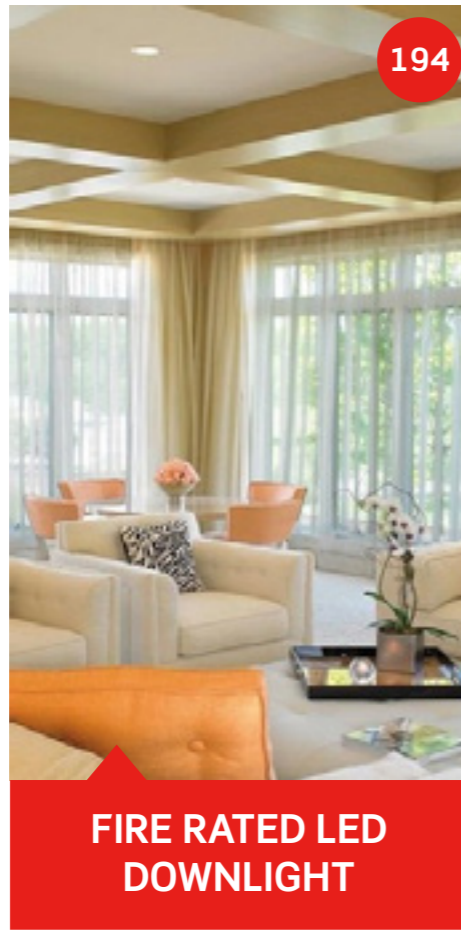

FIRE RATED LED DOWNLIGHT

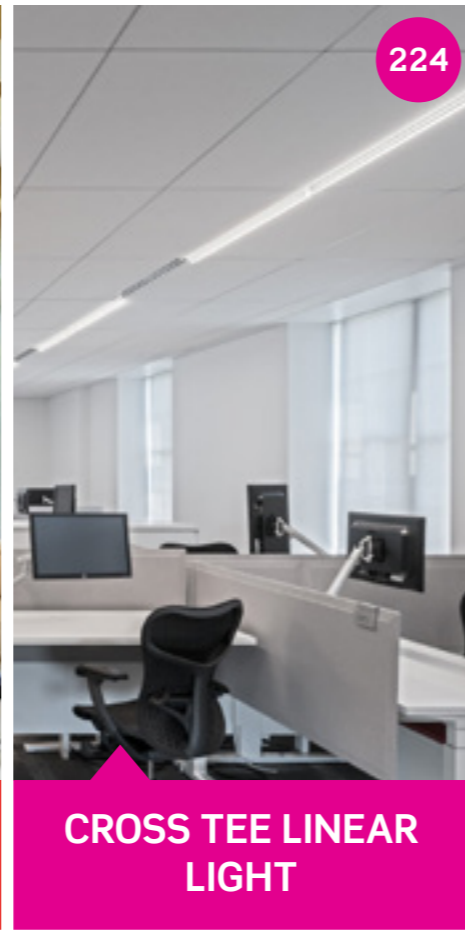

CROSS TEE LINEAR LIGHT

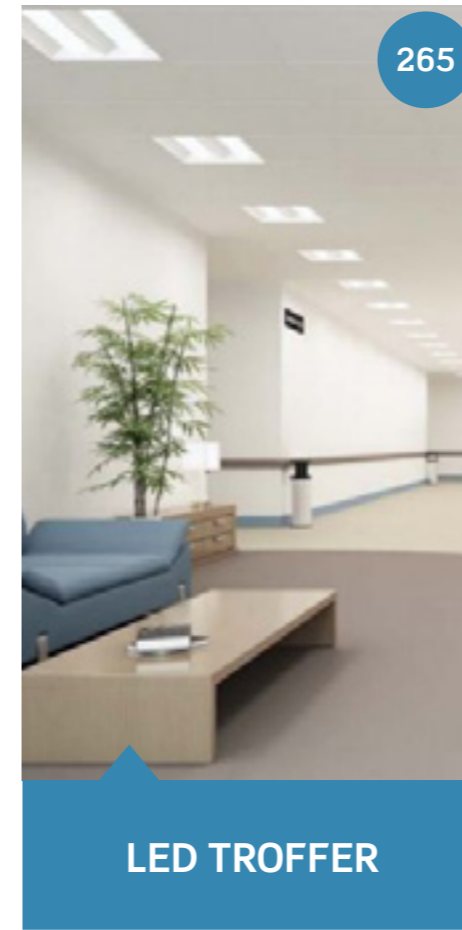

LED TROFFER



LOW PROFILE LED PANEL LIGHT



LED VANITY LIGHT



LED LINEAR WRAP LIGHT



LED TRI-PROOF LIGHT



LED EXIT SIGN

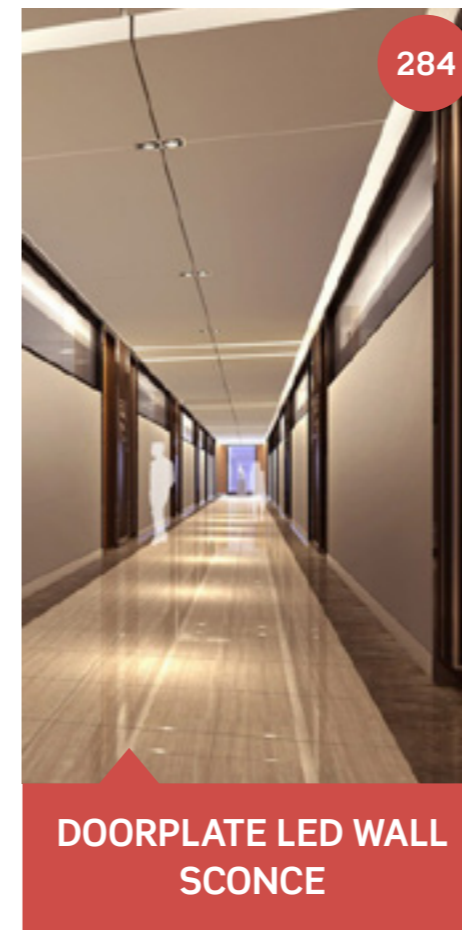

DOORPLATE LED WALL SCNCE

LED MINI SPOTLIGHT / COMMERCIAL

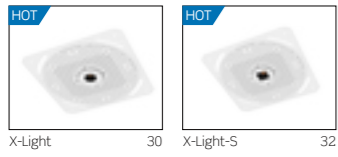

3.5" COB LED RECESSED DOWNLIGHT / COMMERCIAL / RESIDENTIAL

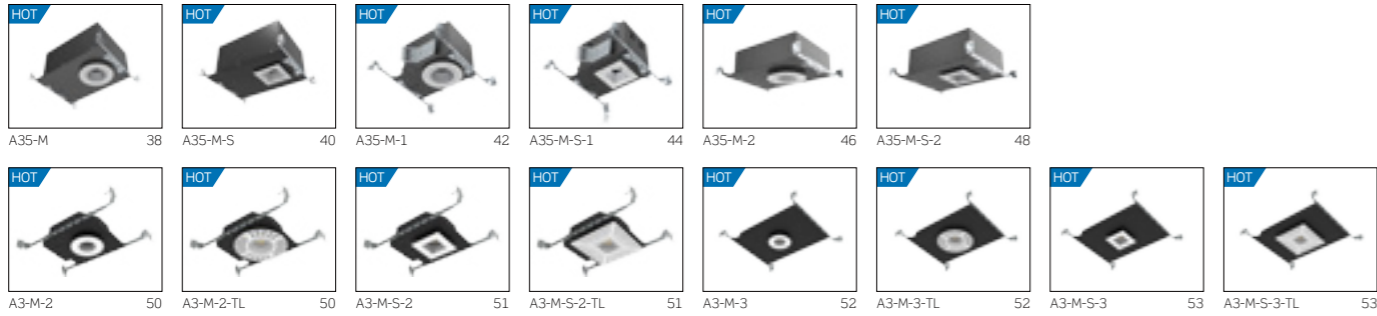

COMMERCIAL DOWNLIGHT / COMMERCIAL



ARCHITECTURAL DOWNLIGHT / COMMERCIAL



DECORATIVE CYLINDERS PENDANT LED DOWNLIGHT / COMMERCIAL/RESIDENTIAL

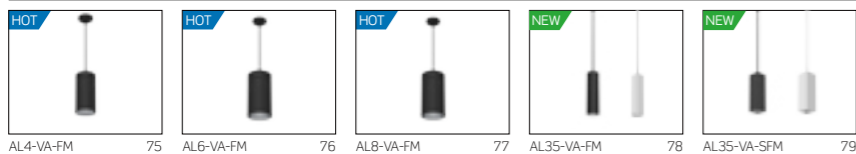

SURFACE MOUNTED LED DOWNLIGHT / COMMERCIAL/RESIDENTIAL



RESIDENTIAL MULTIPLE DOWNLIGHT / RESIDENTIAL



COMMERCIAL MULTIPLE DOWNLIGHT / COMMERCIAL



MINI LED MULTIPLE DOWNLIGHT / COMMERCIAL/RESIDENTIAL



LED WIRELESS SPEAKER LIGHT / COMMERCIAL / RESIDENTIAL



BL10-BS01 144 BL12-BS01-S 145 BL16-BS01 146 BL16-BS01-S 147

DECORATIVE FLUSH MOUNT LED CEILING FIXTURES / COMMERCIAL / RESIDENTIAL



BL4-FM55 152 BL4-SFM55 153 BL6-FM7 154 BL6-SFM7 155 BL8-FM9 156 BL8-SFM9 157 BL12-F11 158 BL12-SFM11 159
BL16-FM15 160 BL16-SFM15 161 BL24-FM24 162 BL24-SFM24 163 BL4-FM55-TL 164 BL4-FM55-TL 165

LED PENDANT LIGHT / COMMERCIAL / RESIDENTIAL

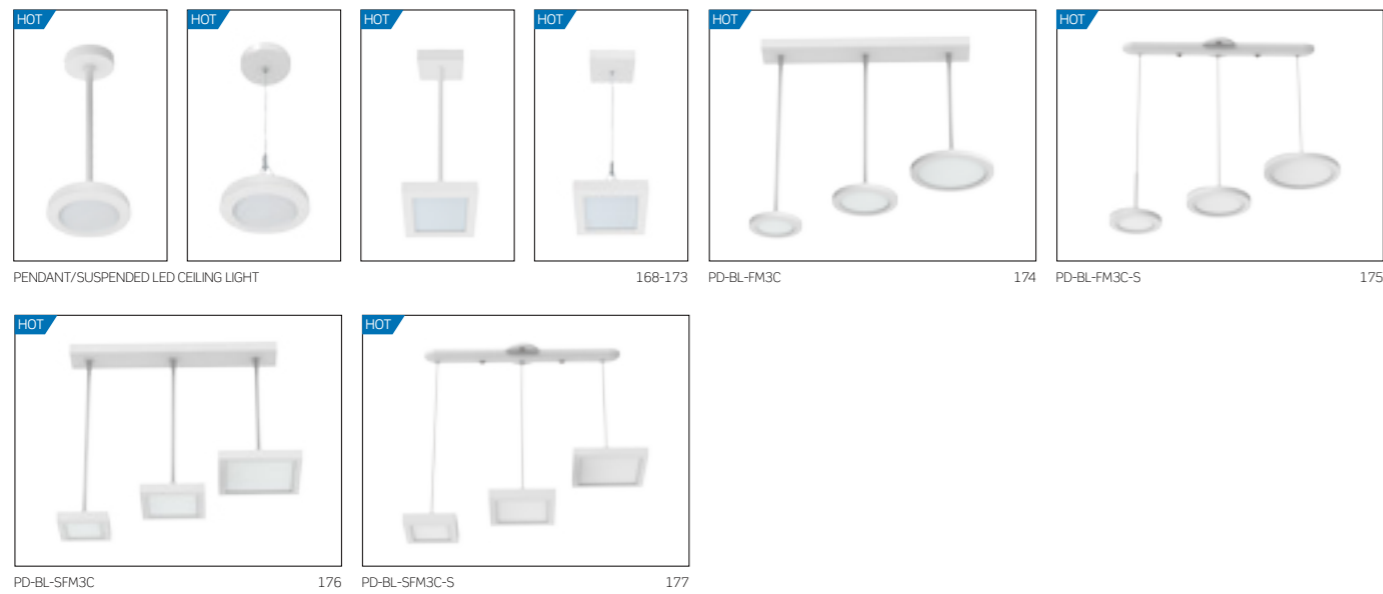

PENDANT/SUSPENDED LED CEILING LIGHT 168-173 PD-BL-FM3C 174 PD-BL-FM3C-S 175
PD-BL-SFM3C 176 PD-BL-SFM3C-S 177

LED TRACK LIGHT / COMMERCIAL / RESIDENTIAL



K3023S 184 K3023M 185 K3023M2 186 K3023L 187 FM3024 188 FM3024A 189 FM3023M 190

LED TRACK LIGHT / COMMERCIAL / RESIDENTIAL

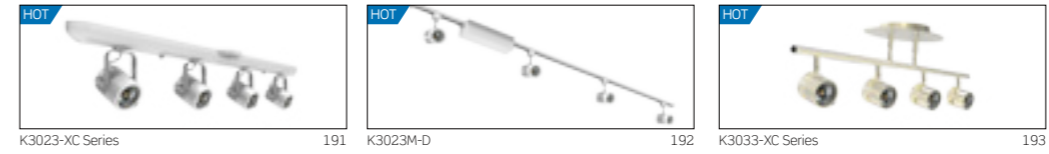

K3023-XC Series 191 K3023M-D 192 K3033-XC Series 193

FIRE RATED LED DOWNLIGHT / COMMERCIAL/RESIDENTIAL

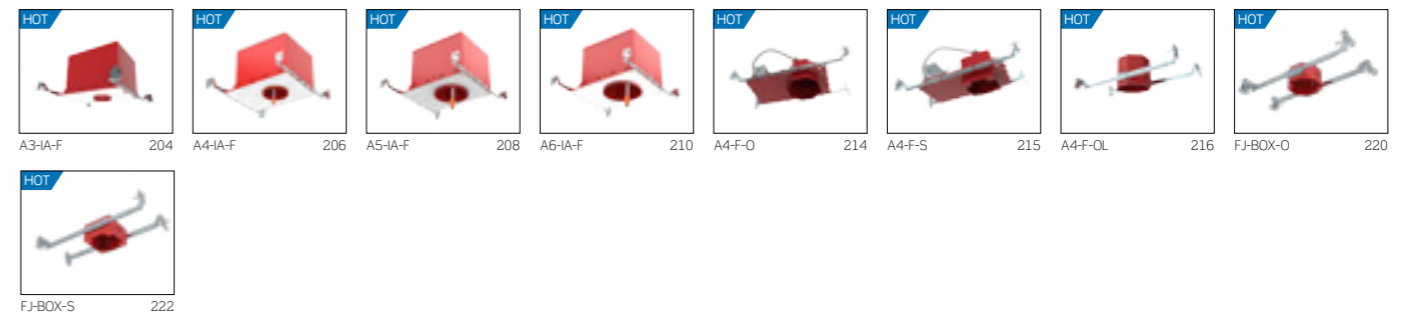

A3-IA-F 204 A4-IA-F 206 A5-IA-F 208 A6-IA-F 210 A4-F-O 214 A4-F-S 215 A4-F-OL 216 FJ-BOX-O 220
FJ-BOX-S 222

CROSS TEE LINEAR LIGHT/ COMMERCIAL / RESIDENTIAL

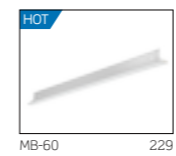

MB-60 229

LED LINEAR WRAP LIGHT/ COMMERCIAL / RESIDENTIAL

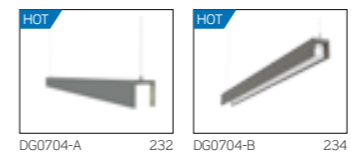

DG0704-A 232 DG0704-B 234

LED TRI-PROOF LIGHT/ COMMERCIAL / RESIDENTIAL

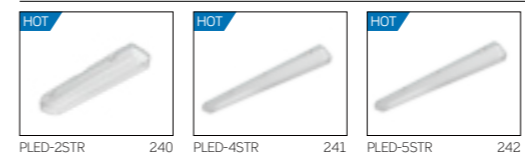

PLED-2STR 240 PLED-4STR 241 PLED-5STR 242

LED EXIT EMERGENCY LIGHT / COMMERCIAL

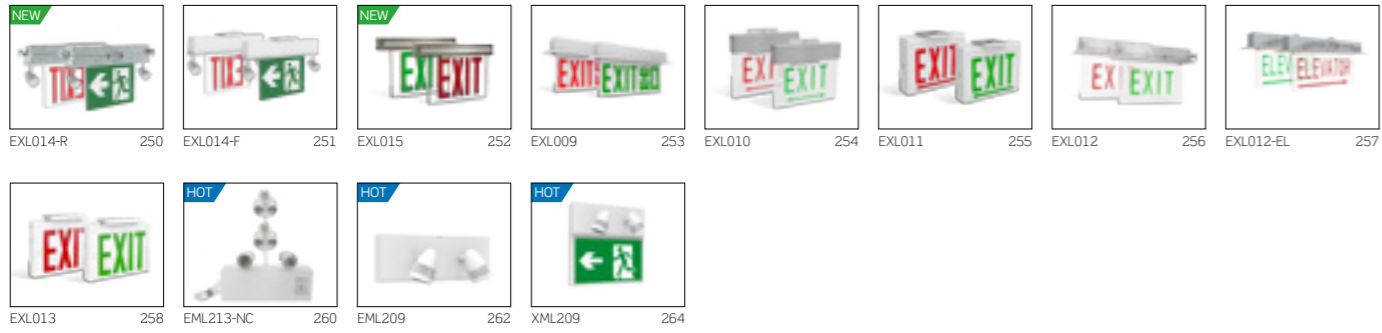

LED TROFFER / COMMERCIAL

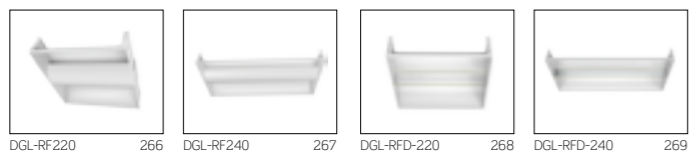

LOW PROFILE LED PANEL LIGHT / COMMERCIAL



LED VANITY LIGHT/ COMMERCIAL



DOORPLATE LED WALL SCNCE / COMMERCIAL / RESIDENTIAL



**HIGH-END
COMMERCIAL/
ARCHITECTURAL
LUMINAIRES**



SUPER MINI



1 inch

Round

Square

X-LIGHT SERIES LED MINI SPOTLIGHT

Liteharbor X-Light is a new design of LED mini spotlight and provides a big breakthrough solution for commercial lighting and architectural lighting. The 1 inch light emitting surface achieves the most extreme mini size.

X-SHAPE
Unique Patent Design Radiator

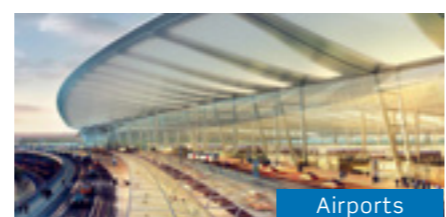
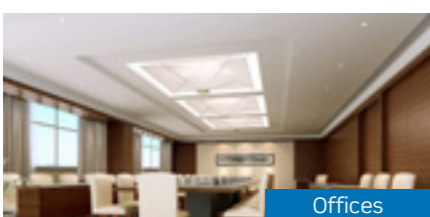
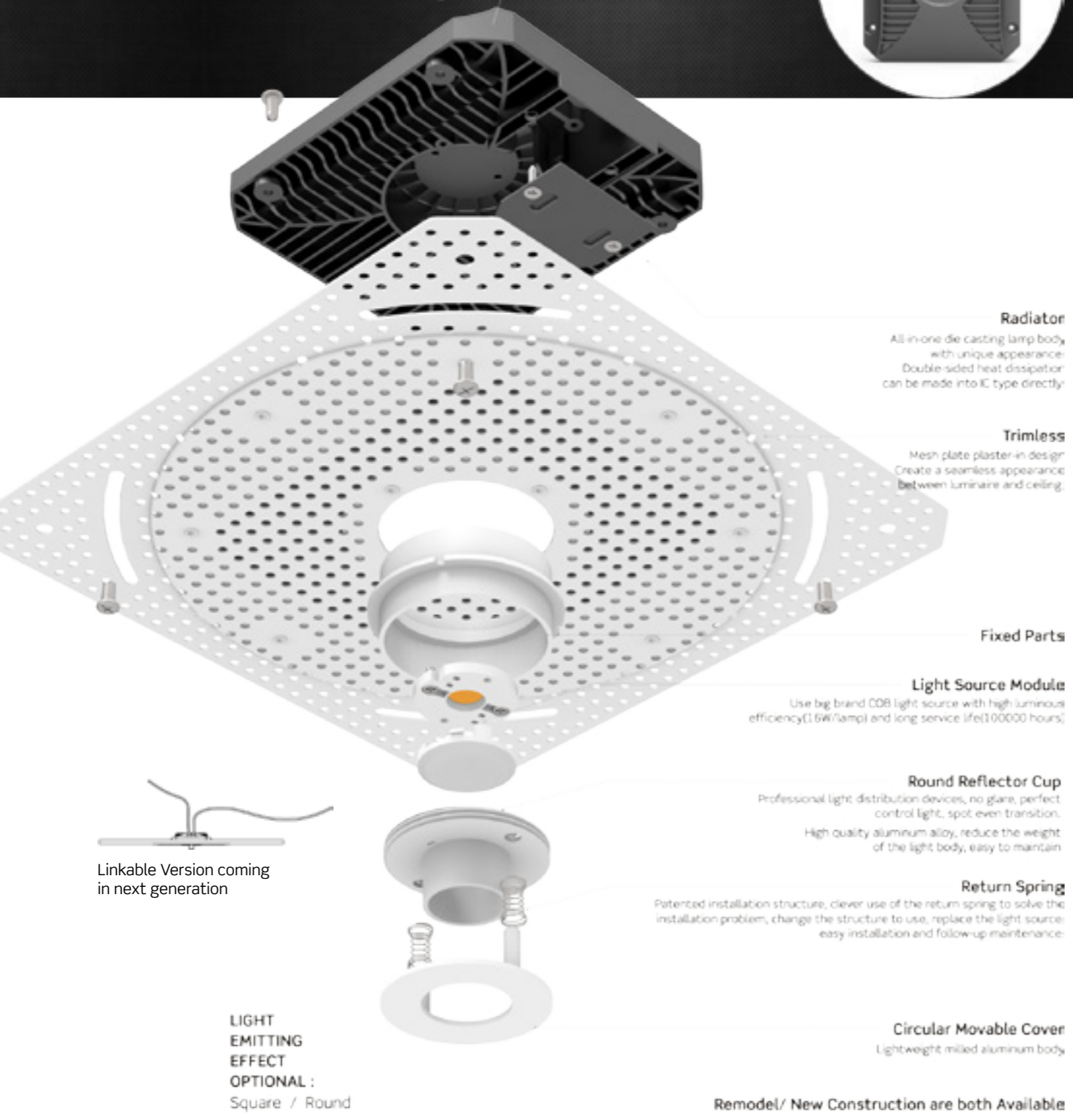

SURFACE MOUNTED



RECESSED MOUNTED



PENDANT MOUNTED

ROUND LED MINI SPOTLIGHT



New Products Coming Soon

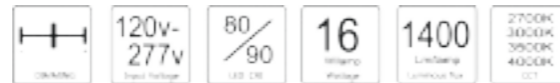

DESCRIPTION

Xiangfei X-Light series, it provides a quick and convenient installation method, provides the solution of the edge of architecture lighting, and makes a big breakthrough in the use and design. 1 inch (Φ25mm) of the light-emitting surface the size to achieve the ultimate.

FEATURES

Xiangfei X-light series with square and round light emission effect. Use big brand COB light source with high luminous efficiency (140lm/w) and long service life (100000 hours). Professional light distribution devices, no glare, perfect control light, spot even transition.

LAMP BODY

Ultra thin, the height of the whole lamp is only 23mm. Ultra small light emitting surface, only 1 inch (Φ25mm). All-in-one die casting lamp body with unique appearance. Double-sided heat dissipation, can be made into IC type directly. The anti-pull device is hidden inside the lamp body.

POWER SUPPLY

Wide voltage input 120-277VAC, 50/60 Hz, 0-10V dimming, constant voltage and constant current mode. The power has UL listed, can be applied to a variety of applications. Integrated power supply, easy to replace the power supply. The input voltage of each lamp is 36V, the load termin can be used independently. Each luminaire is connected in parallel, one power supply can simultaneously control the use of five lamps.

MOUNTING AND MAINTENANCE

Remodel and new construction optional. Wide range of applications, it can be installed in different ceiling thickness, is the real universal type downlight. Cut-out dimensions 142*142mm. The subsequent decoration is also convenient and quick. There is no welding between the light source and the power supply, can replace the LED lamp beads according to the demand.

DIMENSIONS

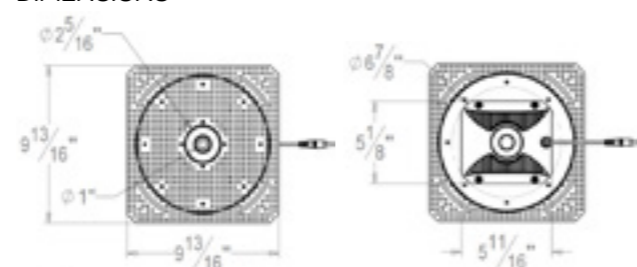

Liteharbor Harbor of Light!

POWER SUPPLY

Wattage	120W Max.
Input Voltage	120-277V AC
Frequency	50/60 Hz
Output Voltage	24V
Electric current	3.4A Max.
Power Factor	>0.9
Dimming	0-10V Dimming

LAMP

Wattage	16W Max./lamp
Input Voltage	24V
CCT	2700K/3000K/3500K/4000K
CRI	80+/90+
Luminous flux	1400lm/lamp
Light source	COB
Dimming	0-10V Dimming
Life span	100000Hours

LISTING / WARRANTY

ETL listed to US and Canadian standards for damp location W/Feed through. 5 Years Limited Warranty.



ROUND LED MINI SPOTLIGHT

SPECTROGRAM

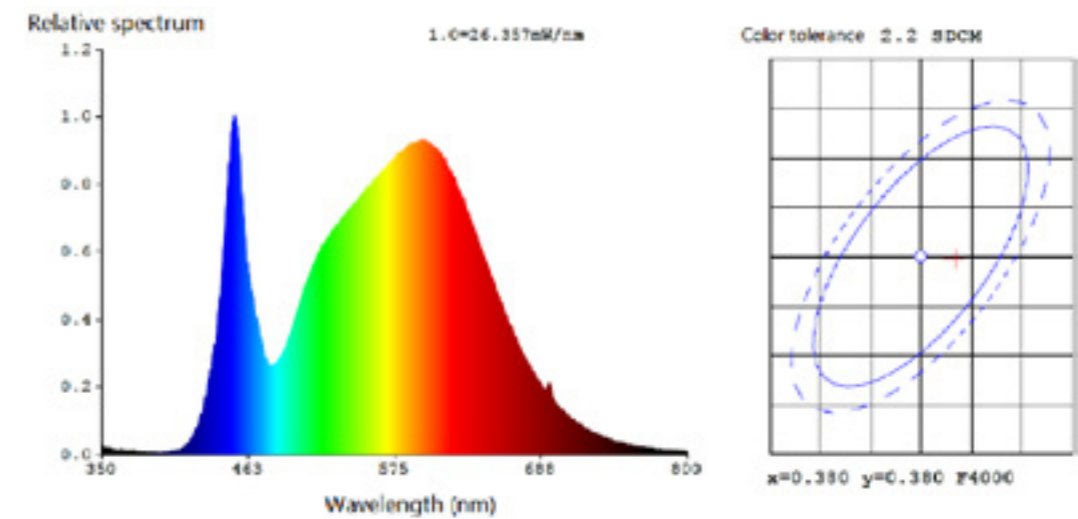

This is the naked test results of the light source and driver.

WIRING DIAGRAM

Each luminaire is connected in parallel, one power supply can simultaneously control the use of Five lamps. The input voltage of each lamp is 24V, the load termin can be used independently.

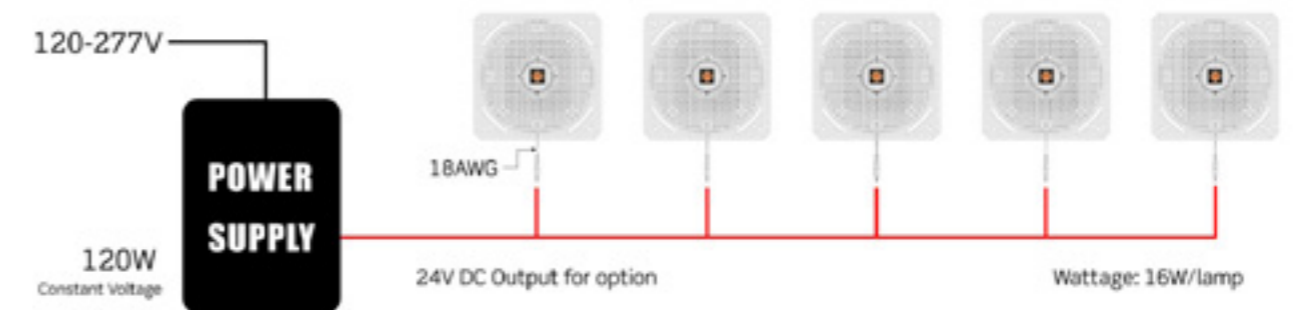

Line Pressure Drop Reference Table

Standard line length Option: 1.5m, 2.5m, 5m, 10m or free combination

What is the maximum wiring distance allowed between the lighting load? It depends on the wire.

Power(W)	Voltage(V)	American wire gage(AWG)	Line length(M)	IP-drop(V)
16W Max.	24V DC Max.	20	≤75	≤5%
		18	≤120	
		16	≤200	
		14	≤300	

Drive power supply output line voltage drop reference table (Uout=24V Plamp=16W Voltage drop≤5)

ORDERING GUIDE / YOUR PRODUCT CODE

SERIES	MOUNTING	CCT	DIMMABLE	CRI	LIGHT SOURCE	CONTROL SYSTEM
<ul style="list-style-type: none"> X-light Round LED Mini Spotlight 	<ul style="list-style-type: none"> Remodel New Construction 	<ul style="list-style-type: none"> 2700K 3000K 3500K 4000K ... RGB RGBW 	<ul style="list-style-type: none"> Non-Dimmable 0-10V dimming 	<ul style="list-style-type: none"> 80+ 90+ 	<ul style="list-style-type: none"> Cree Citizen Epistar Seoul Osram 	<ul style="list-style-type: none"> 0-10V & 1-10V DMX512 3CCT(3500K,4500K,6000K) DALI GRPS Control LED Power Controller PLC SCR SPI WIFI ZIGBEE

* Customized Also Available



www.liteharbor.com

E-mail: info@liteharbor.com



SQUARE LED MINI SPOTLIGHT

LIGHT SOURCE COB LED X-Light-S



New Products Coming Soon

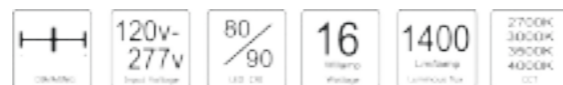

DESCRIPTION

Xiangfei X-Light series, it provides a quick and convenient installation method, provides the solution of the edge of architecture lighting, and makes a big breakthrough in the use and design. 1 inch (Φ25mm) of the light-emitting surface the size to achieve the ultimate.

FEATURES

Xiangfei X-light series with square and circular light emission effect. Use big brand COB light source with high luminous efficiency (140lm/w) and long service life (100000 hours). Professional light distribution devices, no glare, perfect control light, spot even transition.

LAMP BODY

Ultra thin, the height of the whole lamp is only 23mm. Ultra small light emitting surface, only 1 inch (Φ25mm). All-in-one die casting lamp body with unique appearance. Double-sided heat dissipation, can be made into IC type directly. The anti-pull device is hidden inside the lamp body.

POWER SUPPLY

Wide voltage input 120-277VAC, 50/60 Hz, 0-10V dimming, constant voltage and constant current mode. The power has UL listed, can be applied to a variety of applications. Integrated power supply, easy to replace the power supply. The input voltage of each lamp is 36V, the load termin can be used independently. Each luminaire is connected in parallel, one power supply can simultaneously control the use of five lamps.

MOUNTING AND MAINTENANCE

Remodel and new construction optional. Wide range of applications, it can be installed in different ceiling thickness, is the real universal type downlight. Cut-out dimensions 142*142mm. The subsequent decoration is also convenient and quick. There is no welding between the light source and the power supply, can replace the LED lamp beads according to the demand.

DIMENSIONS

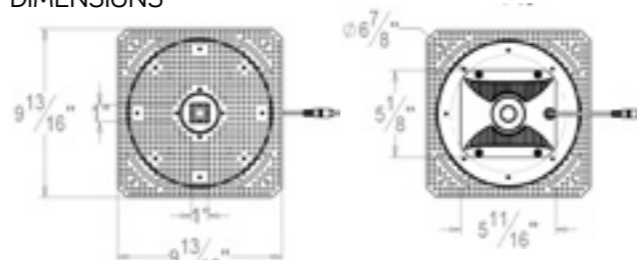

POWER SUPPLY

Wattage	120W Max.
Input Voltage	120-277V AC
Frequency	50/60 Hz
Output Voltage	24V
Electric current	3.4A Max.
Power Factor	>0.9
Dimming	0-10V Dimming

LAMP

Wattage	16W Max./lamp
Input Voltage	24V
CCT	2700K/3000K/3500K/4000K
CRI	80+/90+
Luminous flux	1400lm/lamp
Light source	COB
Dimming	0-10V Dimming
Life span	100000Hours

LISTING / WARRANTY

ETL listed to US and Canadian standards for damp location W/Feed through. 5 Years Limited Warranty.



SQUARE LED MINI SPOTLIGHT

SPECTROGRAM

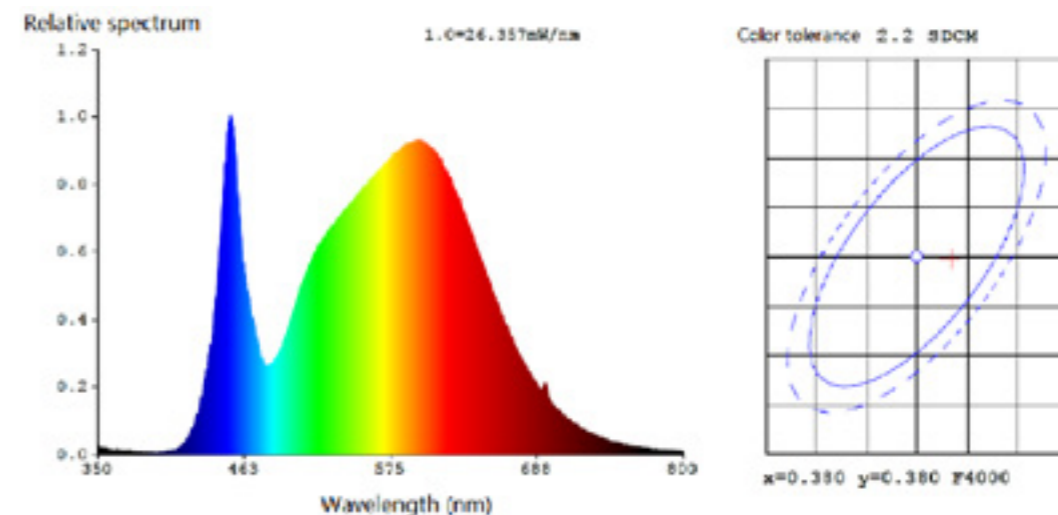

This is the naked test results of the light source and driver.

WIRING DIAGRAM

Each luminaire is connected in parallel, one power supply can simultaneously control the use of Five lamps. The input voltage of each lamp is 24V, the load termin can be used independently.

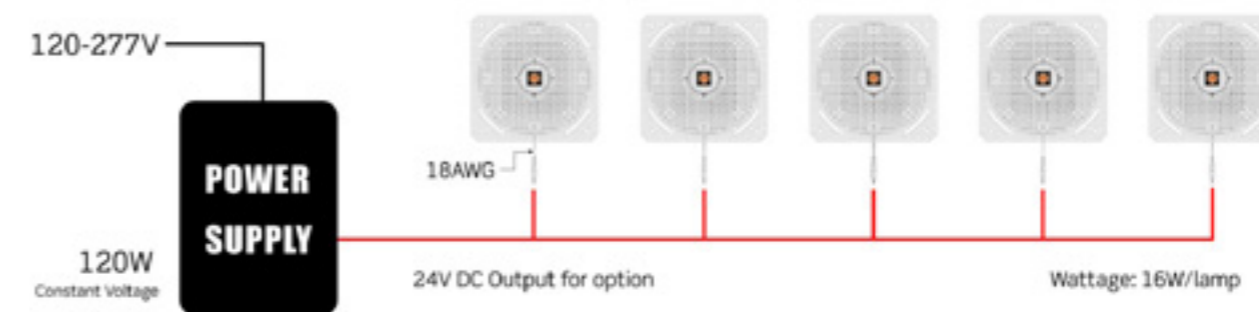

Line Pressure Drop Reference Table

Standard line length Option: 1.5m, 2.5m, 5m, 10m or free combination

What is the maximum wiring distance allowed between the lighting load? It depends on the wire.

Power(W)	Voltage(V)	American wire gage(AWG)	Line length(M)	IP-drop(V)
16W Max.	24V DC Max.	20	≤75	≤5%
		18	≤120	
		16	≤200	
		14	≤300	

Drive power supply output line voltage drop reference table (Uout=24V Plamp=16W Voltage drop≤5)

ORDERING GUIDE / YOUR PRODUCT CODE

SERIES	MOUNTING	CCT	DIMMABLE	CRI	LIGHT SOURCE	CONTROL SYSTEM
<input type="radio"/> X-light-S Square LED Mini Spotlight	<input type="radio"/> Remodel <input type="radio"/> New Construction	<input type="radio"/> 2700K <input type="radio"/> 3000K <input type="radio"/> 3500K <input type="radio"/> 4000K <input type="radio"/> ... <input type="radio"/> RGB <input type="radio"/> RGBW	<input type="radio"/> 0-10V dimming	<input type="radio"/> 80+ <input type="radio"/> 90+	<input type="radio"/> Cree <input type="radio"/> Citizen <input type="radio"/> Epistar <input type="radio"/> Seoul <input type="radio"/> Osram	<input type="radio"/> 0-10V & 1-10V <input type="radio"/> DMX512 <input type="radio"/> 3CCT(3500K,4500K,6000K) <input type="radio"/> DALI <input type="radio"/> GRPS Control <input type="radio"/> LED Power Controller <input type="radio"/> PLC <input type="radio"/> SCR <input type="radio"/> SPI <input type="radio"/> WIFI <input type="radio"/> ZIGBEE

* Customized Also Available



www.liteharbor.com

E-mail: info@liteharbor.com





**COMMERCIAL & RESIDENTIAL
COB LED RECESSED DOWNLIGHT**

3.5 inch LED recessed fixtures with round or square apertures offer energy-efficient, precision lighting for accent, task, or wall wash applications.

LAMP
PERFECT FOR YOUR PROJECT



SMALLER BUT BRIGHTER

3 DIFFERENT BEAM ANGLES TO HELP YOU ACHIEVE PRECISION
LIGHTING SPOT IN EVERY WAY.



Vertical Downlight

The lamp is locked by screw inside and offers vertical down lighting. Round type can achieve 3 beam angles without replacing any parts. Allow for 358 degree rotation. Vertical downlight used with vertical reflector matched.

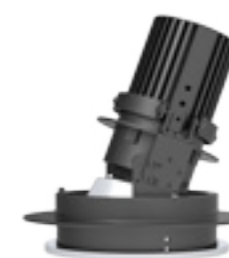

Adjustable Downlight

The lamp can be adjusted by locking to different screw holes. Additional adjustability allows for locking including 30° tilt and 358° rotation. Adjustable downlight used with adjustable reflector matched.

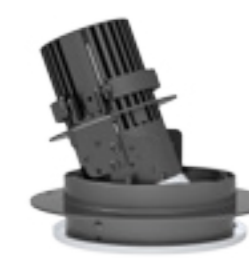

Wall Wash Downlight

High performance wall wash with asymmetric distribution provides uniform illumination. Allow for 358 degree rotation. Wall wash downlight used with wall washing reflector matched.

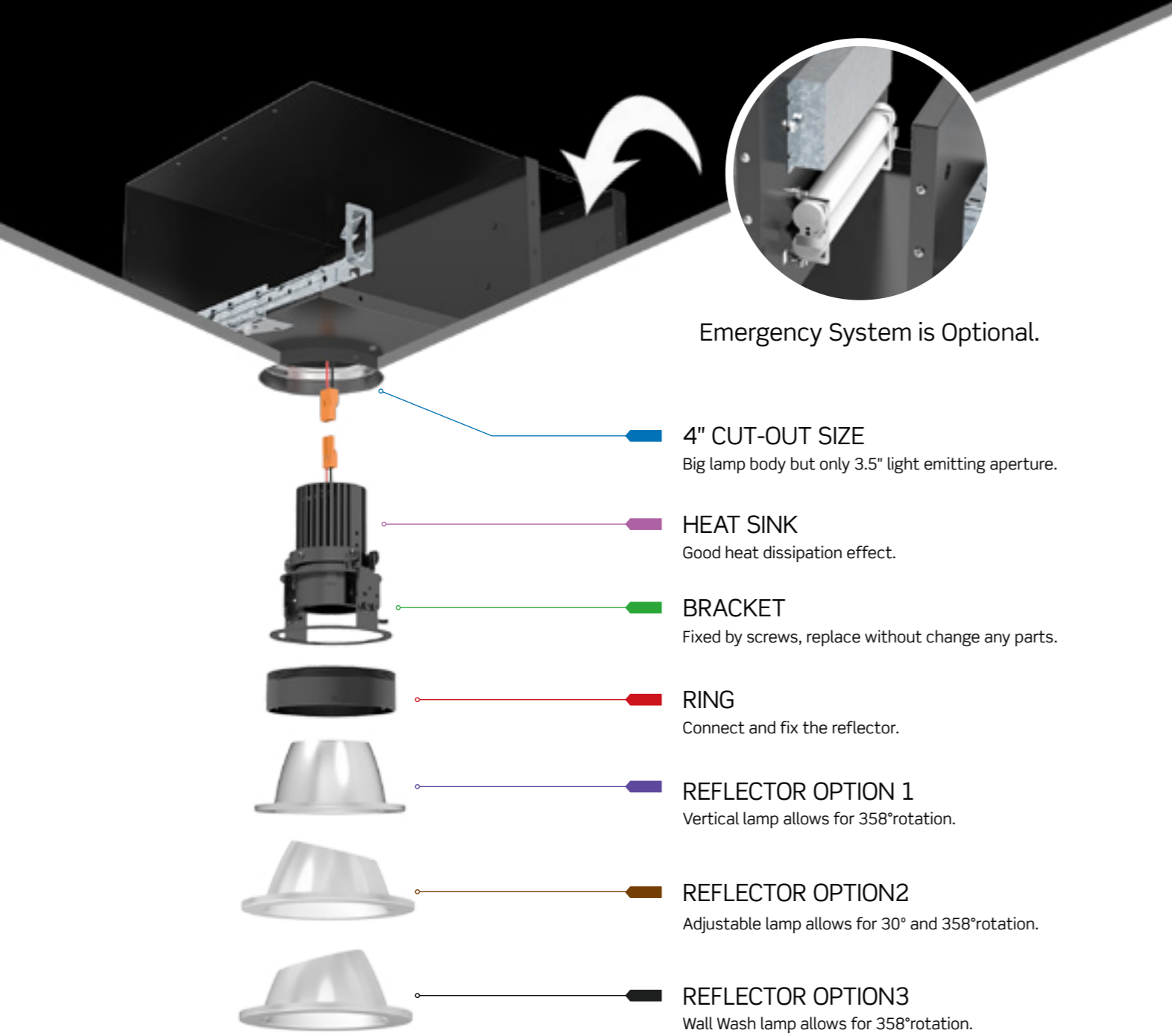

HIGH-END MULTIFUNCTIONAL 3.5 INCH COB LED RECESSED DOWNLIGHT

AVAILABLE FOR RESIDENTIAL & COMMERCIAL APPLICATION

Energy Saving: Ultra energy-efficient, consumes just one-fourth the energy.

Smooth Lighting Effect: Small aperture downlight, provides excellent shielding and glare control.

High Cost Performance: One fixture offers multi-function lighting for accent, task, or wall wash applications.

Extensive Application: Widely used for commercial and residential applications.

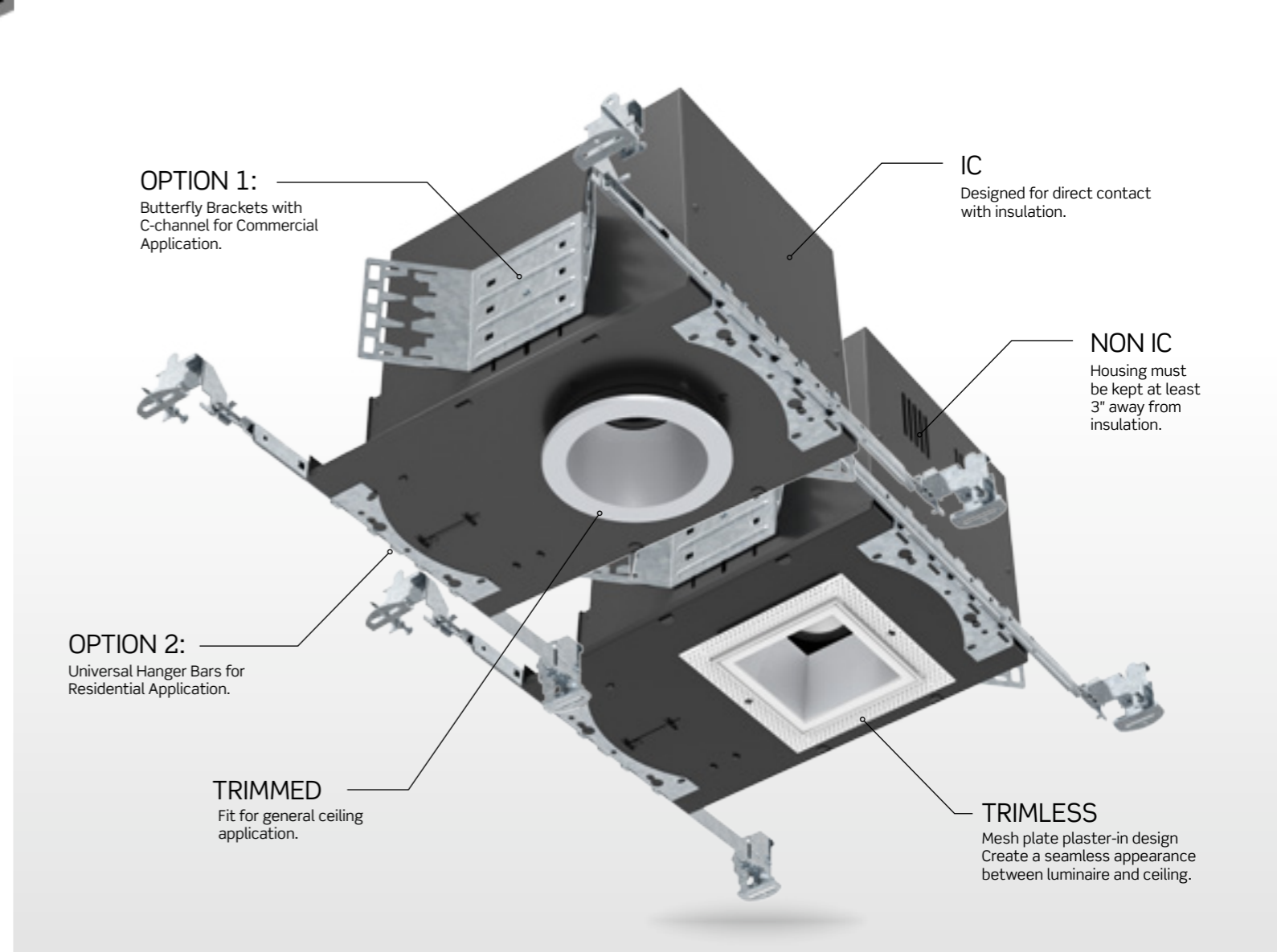

OPTIONAL TOPICS:

1. Round or square aperture is optional.
2. Trimless design is available.
3. NON-IC or IC rated type is optional.
4. Butterfly brackets with C-channel for commercial application

ADJUSTMENT:



358° of rotation



30° of tilt
(for adjustable downlight only)

※ Achieve 3 functions through changing screw setting places and replacing matched reflectors.

3.5" ROUND COB LED RECESSED DOWNLIGHT WITH EMERGENCY SYSTEM



A35-M

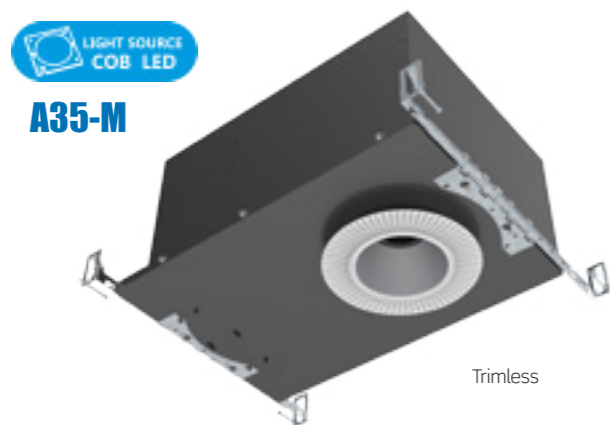

Trimless



Vertical

Adjustable

Wall Wash

※ Achieve 3 functions through changing screw setting places and replacing matched reflectors.

Mounting Type	Recessed Mount
Wattage	12W/15W/20W
Lumen Efficiency	100lm/W
CRI	80+/90+
CCT	2700K/3000K/3500K/4000K
Input Voltage	AC 120V/277V/120-277V
Power Factor	>0.9
Dimming	None/TRIAC/RD 0-10V Dimming
Location	Insulated Ceiling & Damp Locations
Lifespan	50000 Hours at 70% Light Output
Optics	12°/24°/36°



Trimmed



DESCRIPTION

3.5 inch LED recessed fixtures with round or square apertures offer energy-efficient, precision lighting for accent, task, or wall wash applications. This type LED luminaire approximates the performance of 50W halogen, but at only 12-watts input, consumes just one-fourth the energy. A feature enriched, small aperture downlight, the innovative design allows the LED to be positioned closer to the aperture for maximum light output and efficiency or higher to minimize glare and flash on the trim.

FEATURES

Separable rotating reflector design makes it easy for replacement. Provide unique high-low lamp positioning with the simple twist of a screwdriver. Optimize the design of emergency power supply to ensure the battery life. Power supply using isolation scheme, driver can achieve high power factor and conversion efficiency, constant current output. Universal 120V-277V driver with optional 0-10V standard dimming protocol.

HOUSING

Heavy duty black powder coated cold roll steel frame. Design for New Construction installation. Standard housing accommodates 1/2" ceiling thickness. Housing types include IC Air-Tight or Non-IC Rated (must specify). Junction box and driver are located on opposite ends of the housing, with easy access for maintenance and installation.

EMERGENCY OPTION

Remote test switch included. Emergency driver operates LED load of up to 7.0 Watts at a maximum rated current (270 mA) for a minimum of 90 minutes.

OPTICS

12° Spot, 24° Narrow Flood and 36° Flood.

APPLICATIONS

Widely used for commercial and residential applications.

DIMENSIONS

L: 16 7/8"
W: 11 5/16"
H: 8 1/16"
Ø: 4"

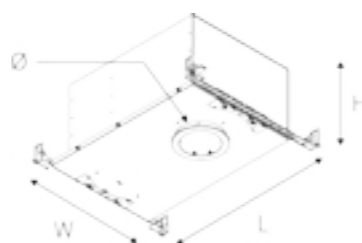

LISTING / WARRANTY

ETL listed to US and Canadian standards for damp location W/Feed through. 5 Years Limited Warranty.



3.5" ROUND COB LED RECESSED DOWNLIGHT WITH EMERGENCY SYSTEM

LIGHT DISTRIBUTION CURVE

For Vertical Lamp

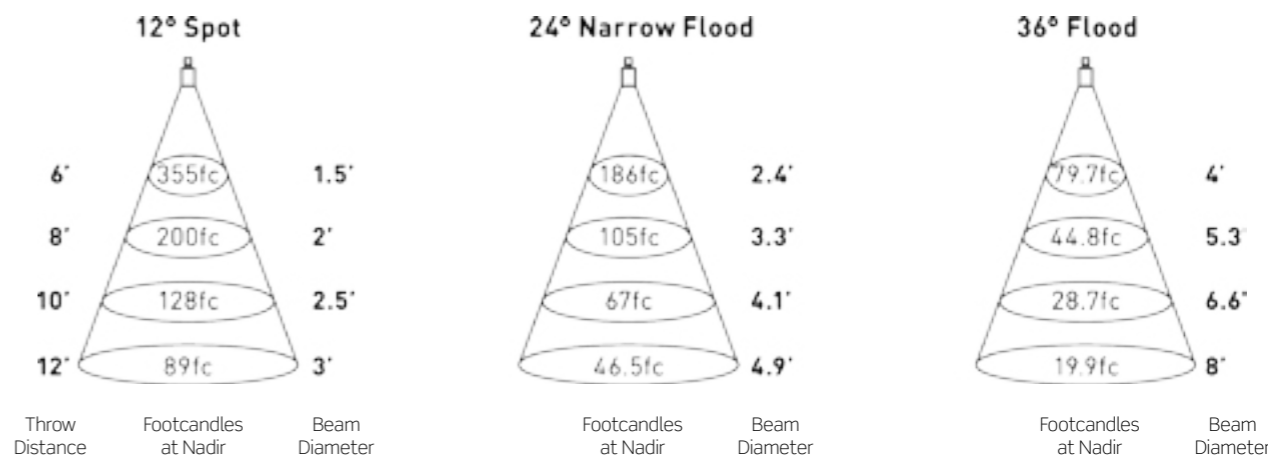

COLOR TEMPERATURE

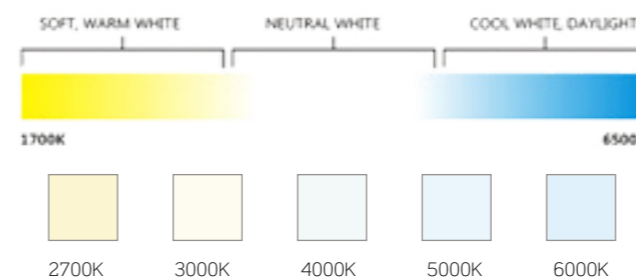

PACKING



- CTN Size:
L:415xW:400xH:270mm
- Inner Box Size:
L:385xW:200xH:245mm
- 2 PCS/CTN

ORDERING GUIDE / YOUR PRODUCT CODE

SERIES	TRIM	HOUSING TYPE	FRAME	FUNCTIONS	OPTICS	CONTROL SYSTEM
<input type="radio"/> A35-M 3.5" Round Downlight	<input type="radio"/> TRIMMED <input type="radio"/> TRIMLESS	<input type="radio"/> NON-IC <input type="radio"/> IC	<input type="radio"/> Butterfly Brackets with C-channel <input type="radio"/> Universal Hanger Bar	<input type="radio"/> Vertical Downlight <input type="radio"/> Adjustable Downlight <input type="radio"/> Wall Wash Downlight	<input type="radio"/> 12° Spot <input type="radio"/> 24° Narrow Flood <input type="radio"/> 36° Flood	<input type="radio"/> 0-10V & 1-10V <input type="radio"/> DMX512 <input type="radio"/> 3CCT (3500K,4500K,6000K) <input type="radio"/> DALI <input type="radio"/> GRPS Control <input type="radio"/> LED Power Controller <input type="radio"/> PLC <input type="radio"/> SCR <input type="radio"/> SPI <input type="radio"/> WIFI <input type="radio"/> ZIGBEE
INPUT VOLTAGE	WATTAGE	CCT	LED AVAILABLE	DIMMABLE	FINISH	
<input type="radio"/> 120V <input type="radio"/> 277V <input type="radio"/> 120-277V	<input type="radio"/> LED 12W <input type="radio"/> LED 15W <input type="radio"/> LED 20W	<input type="radio"/> 2700K <input type="radio"/> 3000K <input type="radio"/> 3500K <input type="radio"/> 4000K <input type="radio"/> ... <input type="radio"/> RGB <input type="radio"/> RGBW	<input type="radio"/> Cree <input type="radio"/> Citizen <input type="radio"/> Epistar <input type="radio"/> Seoul <input type="radio"/> Osram	<input type="radio"/> Non-Dimmable <input type="radio"/> TRIAC Dimming <input type="radio"/> 0-10V Dimming	<input type="radio"/> White <input type="radio"/> Black <input type="radio"/> Satin Nickel	

* Customized Also Available

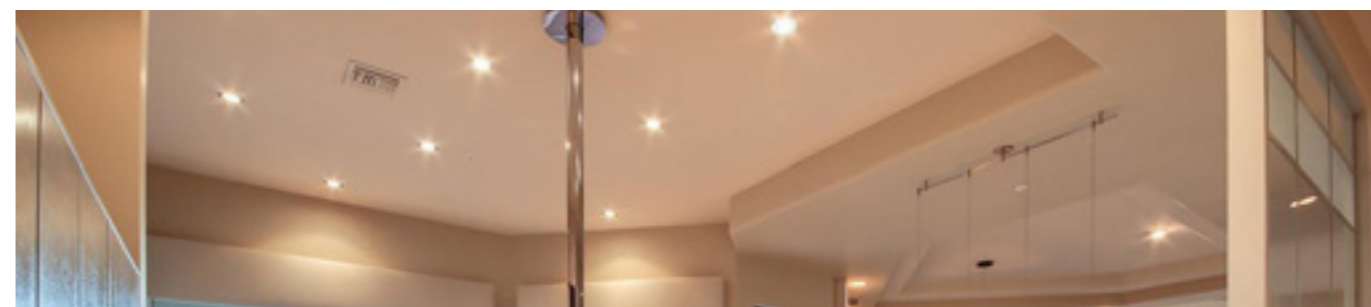

3.5" SQUARE COB LED RECESSED DOWNLIGHT WITH EMERGENCY SYSTEM



A35-M-S

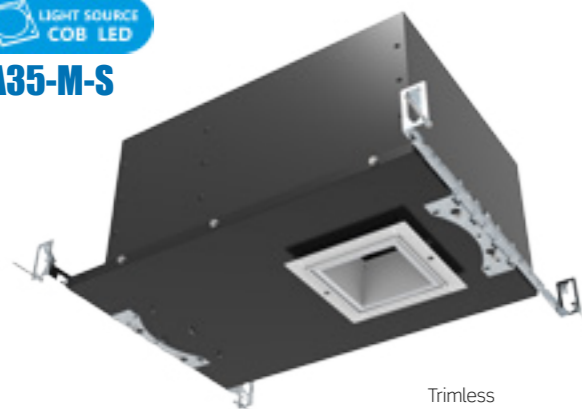

Trimless

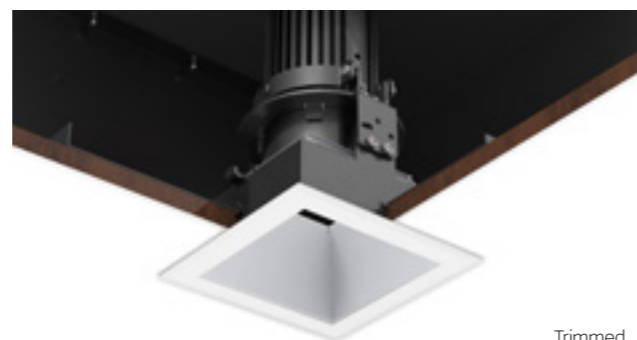

Trimmed



Vertical

Adjustable

Wall Wash

※ Achieve 3 functions through changing screw setting places and replacing matched reflectors.

Mounting Type	Recessed Mount
Wattage	12W/15W/20W
Lumen Efficiency	100lm/W
CRI	80+/90+
CCT	2700K/3000K/3500K/4000K
Input Voltage	AC 120V/277V/120-277V
Power Factor	>0.9
Dimming	None/TRIAC/RD 0-10V Dimming
Location	Insulated Ceiling & Damp Locations
Lifespan	50000 Hours at 70% Light Output
Optics	12°/24°/36°

DESCRIPTION

3.5 inch LED recessed fixtures with round or square apertures offer energy-efficient, precision lighting for accent, task, or wall wash applications. This type LED luminaire approximates the performance of 50W halogen, but at only 12-watts input, consumes just one-fourth the energy. A feature enriched, small aperture downlight, the innovative design allows the LED to be positioned closer to the aperture for maximum light output and efficiency or higher to minimize glare and flash on the trim.

FEATURES

Separable rotating reflector design makes it easy for replacement. Provide unique high-low lamp positioning with the simple twist of a screwdriver. Optimize the design of emergency power supply to ensure the battery life. Power supply using isolation scheme, driver can achieve high power factor and conversion efficiency, constant current output. Universal 120V-277V driver with optional 0-10V standard dimming protocol.

HOUSING

Heavy duty black powder coated cold roll steel frame. Design for New Construction installation. Standard housing accommodates 1/2" ceiling thickness. Housing types include IC Air-Tight or Non-IC Rated (must specify). Junction box and driver are located on opposite ends of the housing, with easy access for maintenance and installation.

EMERGENCY OPTION

Remote test switch included. Emergency driver operates LED load of up to 7.0 Watts at a maximum rated current (270 mA) for a minimum of 90 minutes.

OPTICS

12° Spot, 24° Narrow Flood and 36° Flood.

APPLICATIONS

Widely used for commercial and residential applications.

DIMENSIONS

L: 16 9/16"

W: 11 11/16"

H: 7 3/4"

a: 4 1/16"

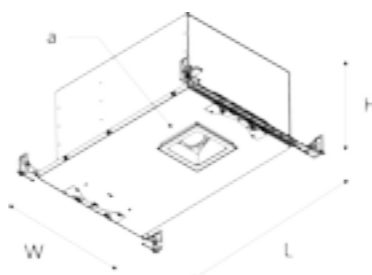

LISTING / WARRANTY

ETL listed to US and Canadian standards for damp location W/Feed through. 5 Years Limited Warranty.



3.5" SQUARE COB LED RECESSED DOWNLIGHT WITH EMERGENCY SYSTEM

LIGHT DISTRIBUTION CURVE For Vertical Lamp

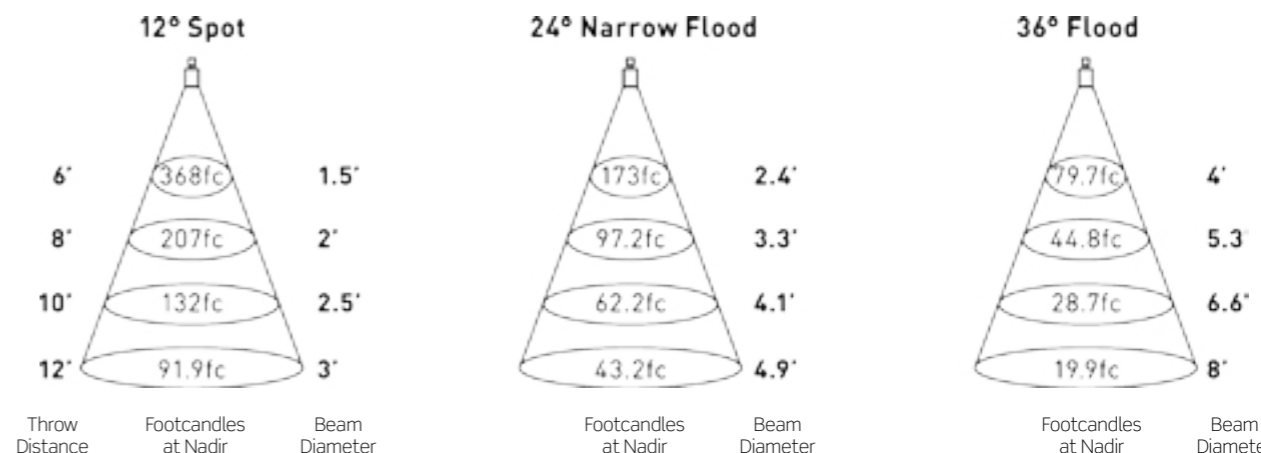

COLOR TEMPERATURE

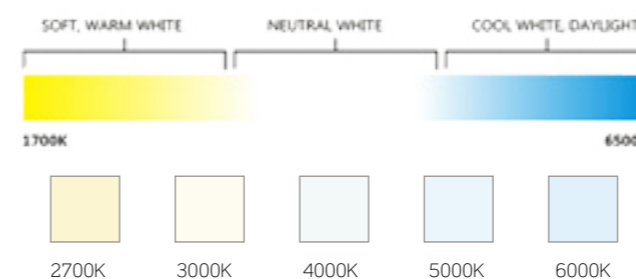

PACKING

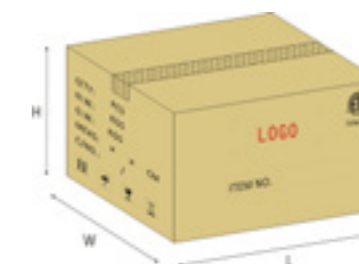

- CTN Size:
L:415xW:400xH:270mm

- Inner Box Size:
L:385xW:200xH:245mm

- 2 PCS/CTN

ORDERING GUIDE / YOUR PRODUCT CODE

SERIES	TRIM	HOUSING TYPE	FRAME	FUNCTIONS	OPTICS	CONTROL SYSTEM
<input type="radio"/> A35-M-S 3.5" Square Downlight	<input type="radio"/> TRIMMED <input type="radio"/> TRIMLESS	<input type="radio"/> NON-IC <input type="radio"/> IC	<input type="radio"/> Butterfly Brackets with C-channel <input type="radio"/> Universal Hanger Bar	<input type="radio"/> Vertical Downlight <input type="radio"/> Adjustable Downlight <input type="radio"/> Wall Wash Downlight	<input type="radio"/> 12° Spot <input type="radio"/> 24° Narrow Flood <input type="radio"/> 36° Flood	<input type="radio"/> 0-10V & 1-10V <input type="radio"/> DMX512 <input type="radio"/> 3CCT (3500K,4500K,6000K) <input type="radio"/> DALI <input type="radio"/> GRPS Control <input type="radio"/> LED Power Controller <input type="radio"/> PLC <input type="radio"/> SCR <input type="radio"/> SPI <input type="radio"/> WIFI <input type="radio"/> ZIGBEE
INPUT VOLTAGE	WATTAGE	CCT	LED AVAILABLE	DIMMABLE	FINISH	
<input type="radio"/> 120V <input type="radio"/> 277V <input type="radio"/> 120-277V	<input type="radio"/> LED 12W <input type="radio"/> LED 15W <input type="radio"/> LED 20W	<input type="radio"/> 2700K <input type="radio"/> 3000K <input type="radio"/> 3500K <input type="radio"/> 4000K <input type="radio"/> ... <input type="radio"/> RGB <input type="radio"/> RGBW	<input type="radio"/> Cree <input type="radio"/> Citizen <input type="radio"/> Epistar <input type="radio"/> Seoul <input type="radio"/> Osram	<input type="radio"/> Non-Dimmable <input type="radio"/> TRIAC Dimming <input type="radio"/> 0-10V Dimming	<input type="radio"/> White <input type="radio"/> Black <input type="radio"/> Satin Nickel	

* Customized Also Available

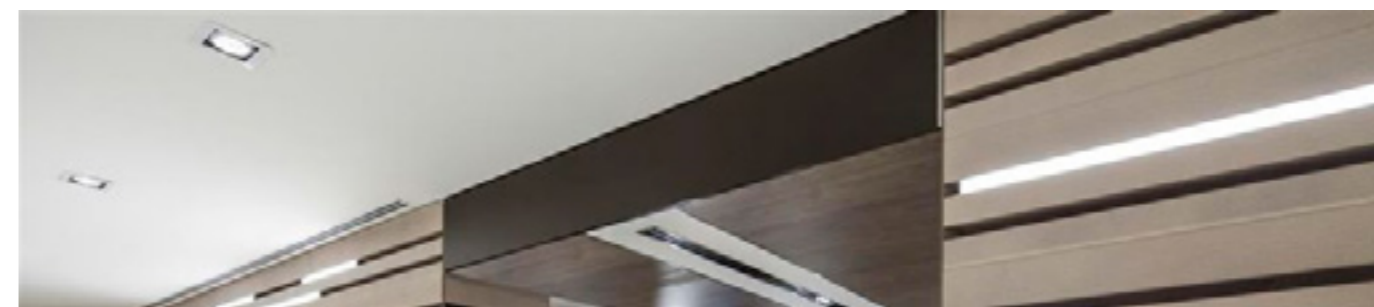

HIGH PERFORMANCE 3.5" ROUND COB LED RECESSED DOWNLIGHT KITS



A35-M-1



※ Achieve 3 functions through changing screw setting places and replacing matched reflectors.



DESCRIPTION

3.5 inch LED recessed fixtures with round or square apertures offer energy-efficient, precision lighting for accent, task, or wall wash applications. This type LED luminaire approximates the performance of 50W halogen, but at only 12-watts input, consumes just one-fourth the energy. A feature enriched, small aperture downlight, the innovative design allows the LED to be positioned closer to the aperture for maximum light output and efficiency or higher to minimize glare and flash on the trim.

FEATURES

Separable rotating reflector design makes it easy for replacement. Provide unique high-low lamp positioning with the simple twist of a screwdriver. Power supply using isolation scheme, driver can achieve high power factor and conversion efficiency, constant current output. Universal 120V-277V driver with optional 0-10V standard dimming protocol.

HOUSING

Heavy duty black powder coated cold roll steel frame. Design for New Construction installation. Standard housing accommodates 1/2" ceiling thickness. Housing types include IC Air-Tight or Non-IC Rated (must specify). Junction box and driver are located on opposite ends of the housing, with easy access for maintenance and installation. Optional round or square aperture shape. Trimless design is available.

OPTICS

12° Spot, 24° Narrow Flood and 36° Flood.

APPLICATIONS

Widely used for commercial and residential applications.

DIMENSIONS

L: 12 1/16"
W: 7 1/2"
H: 7 7/8"
Ø: 4"

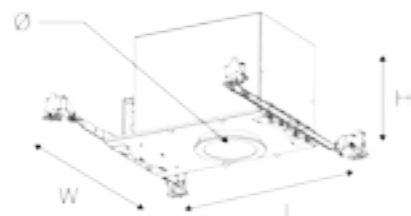

Mounting Type	Recessed Mount
Wattage	12W/15W/20W
Lumen Efficiency	100lm/W
CRI	80+/90+
CCT	2700K/3000K/3500K/4000K
Input Voltage	AC 120V/277V/120-277V
Power Factor	>0.9
Dimming	None/TRIAC/RD 0-10V Dimming
Location	Insulated Ceiling & Damp Locations
Lifespan	50000 Hours at 70% Light Output
Optics	12°/24°/36°

LISTING / WARRANTY

ETL listed to US and Canadian standards for damp location W/Feed through. 5 Years Limited Warranty.



HIGH PERFORMANCE 3.5" ROUND COB LED RECESSED DOWNLIGHT KITS

LIGHT DISTRIBUTION CURVE For Adjustable Lamp

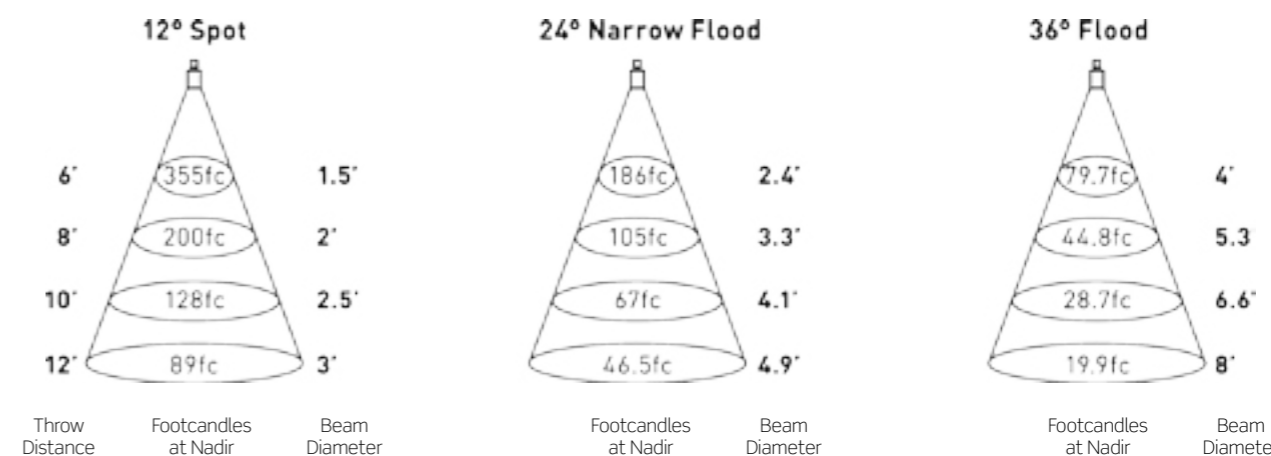

COLOR TEMPERATURE

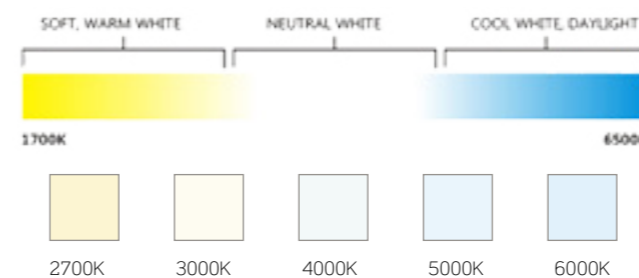

PACKING

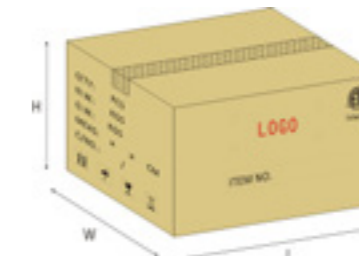

- CTN Size:
L:415xW:400xH:270mm

- Inner Box Size:
L:385xW:200xH:245mm

- 2 PCS/CTN

ORDERING GUIDE / YOUR PRODUCT CODE

SERIES	TRIM	HOUSING TYPE	FRAME	FUNCTIONS	OPTICS	CONTROL SYSTEM
<input type="radio"/> A35-M-1 3.5" Downlight	<input type="radio"/> TRIMMED <input type="radio"/> TRIMLESS	<input type="radio"/> NON-IC <input type="radio"/> IC	<input type="radio"/> Butterfly Brackets with C-channel <input type="radio"/> Universal Hanger Bar	<input type="radio"/> Vertical Downlight <input type="radio"/> Adjustable Downlight <input type="radio"/> Wall Wash Downlight	<input type="radio"/> 12° Spot <input type="radio"/> 24° Narrow Flood <input type="radio"/> 36° Flood	<input type="radio"/> 0-10V & 1-10V <input type="radio"/> DMX512 <input type="radio"/> 3CCT (3500K,4500K,6000K) <input type="radio"/> DALI <input type="radio"/> GRPS Control <input type="radio"/> LED Power Controller <input type="radio"/> PLC <input type="radio"/> SCR <input type="radio"/> SPI <input type="radio"/> WIFI <input type="radio"/> ZIGBEE
INPUT VOLTAGE	WATTAGE	CCT	LED AVAILABLE	DIMMABLE	FINISH	
<input type="radio"/> 120V <input type="radio"/> 277V <input type="radio"/> 120-277V	<input type="radio"/> LED 12W <input type="radio"/> LED 15W <input type="radio"/> LED 20W	<input type="radio"/> 2700K <input type="radio"/> 3000K <input type="radio"/> 3500K <input type="radio"/> 4000K <input type="radio"/> ... <input type="radio"/> RGB <input type="radio"/> RGBW	<input type="radio"/> Cree <input type="radio"/> Citizen <input type="radio"/> Epistar <input type="radio"/> Seoul <input type="radio"/> Osram	<input type="radio"/> Non-Dimmable <input type="radio"/> TRIAC Dimming <input type="radio"/> 0-10V Dimming	<input type="radio"/> White <input type="radio"/> Black <input type="radio"/> Satin Nickel	

* Customized Also Available



HIGH PERFORMANCE 3.5" SQUARE COB LED RECESSED DOWNLIGHT KITS

LIGHT SOURCE
COB LED
A35-M-S-1



DESCRIPTION

3.5 inch LED recessed fixtures with round or square apertures offer energy-efficient, precision lighting for accent, task, or wall wash applications. This type LED luminaire approximates the performance of 50W halogen, but at only 12-watts input, consumes just one-fourth the energy. A feature enriched, small aperture downlight, the innovative design allows the LED to be positioned closer to the aperture for maximum light output and efficiency or higher to minimize glare and flash on the trim.

FEATURES

Separable rotating reflector design makes it easy for replacement. Provide unique high-low lamp positioning with the simple twist of a screwdriver. Power supply using isolation scheme, driver can achieve high power factor and conversion efficiency, constant current output. Universal 120V-277V driver with optional 0-10V standard dimming protocol.

HOUSING

Heavy duty black powder coated cold roll steel frame. Design for New Construction installation. Standard housing accommodates 1/2" ceiling thickness. Housing types include IC Air-Tight or Non-IC Rated (must specify). Junction box and driver are located on opposite ends of the housing, with easy access for maintenance and installation. Optional round or square aperture shape. Trimless design is available.

OPTICS

12° Spot, 24° Narrow Flood and 36° Flood.

APPLICATIONS

Widely used for commercial and residential applications.

DIMENSIONS

L: 12 1/16"
W: 7 1/2"
H: 7 3/4"
a: 4 1/16"

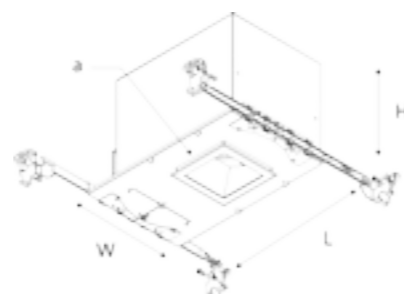

Mounting Type	Recessed Mount
Wattage	12W/15W/20W
Lumen Efficiency	100lm/W
CRI	80+/90+
CCT	2700K/3000K/3500K/4000K
Input Voltage	AC 120V/277V/120-277V
Power Factor	>0.9
Dimming	None/TRIAC/RD 0-10V Dimming
Location	Insulated Ceiling & Damp Locations
Lifespan	50000 Hours at 70% Light Output
Optics	12°/24°/36°

LISTING / WARRANTY

ETL listed to US and Canadian standards for damp location W/Feed through. 5 Years Limited Warranty.



HIGH PERFORMANCE 3.5" SQUARE COB LED RECESSED DOWNLIGHT KITS

LIGHT DISTRIBUTION CURVE For Adjustable Lamp

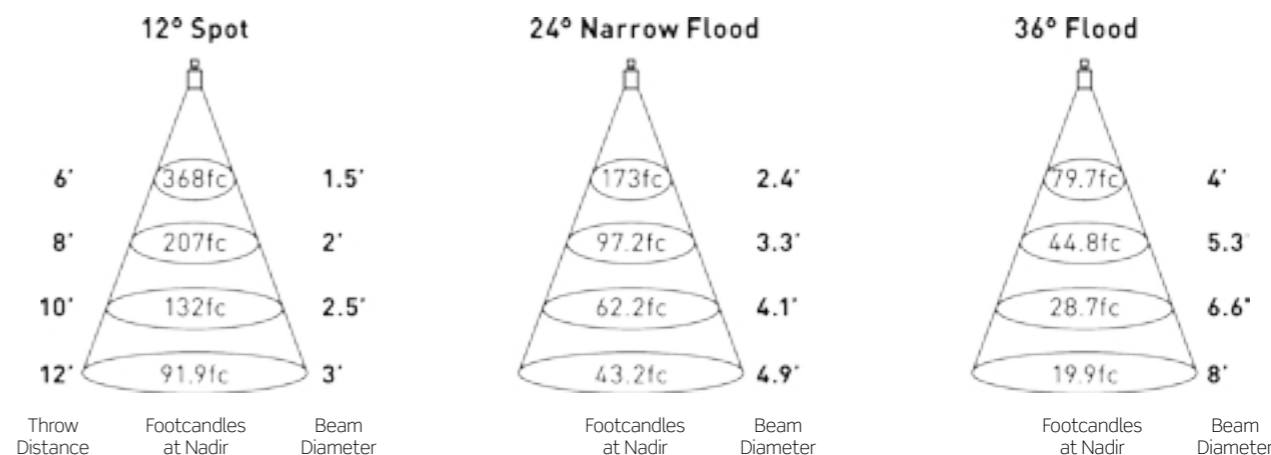

COLOR TEMPERATURE

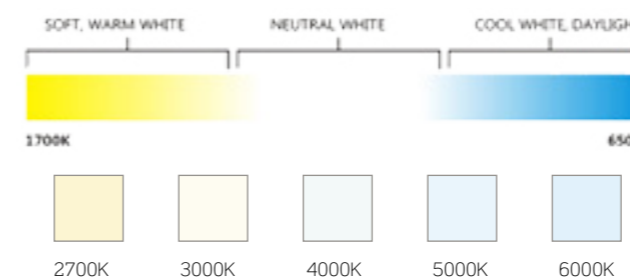

PACKING



- CTN Size:
L:415xW:400xH:270mm
- Inner Box Size:
L:385xW:200xH:245mm
- 2 PCS/CTN

ORDERING GUIDE / YOUR PRODUCT CODE

SERIES	TRIM	HOUSING TYPE	FRAME	FUNCTIONS	OPTICS	CONTROL SYSTEM
<input type="radio"/> A35-M-S-1 3.5" Downlight	<input type="radio"/> TRIMMED <input type="radio"/> TRIMLESS	<input type="radio"/> NON-IC <input type="radio"/> IC	<input type="radio"/> Butterfly Brackets with C-channel <input type="radio"/> Universal Hanger Bar	<input type="radio"/> Vertical Downlight <input type="radio"/> Adjustable Downlight <input type="radio"/> Wall Wash Downlight	<input type="radio"/> 12° Spot <input type="radio"/> 24° Narrow Flood <input type="radio"/> 36° Flood	<input type="radio"/> 0-10V & 1-10V <input type="radio"/> DMX512 <input type="radio"/> 3CCT (3500K,4500K,6000K) <input type="radio"/> DALI <input type="radio"/> GRPS Control <input type="radio"/> LED Power Controller <input type="radio"/> PLC <input type="radio"/> SCR <input type="radio"/> SPI <input type="radio"/> WIFI <input type="radio"/> ZIGBEE
INPUT VOLTAGE	WATTAGE	CCT	LED AVAILABLE	DIMMABLE	FINISH	
<input type="radio"/> 120V <input type="radio"/> 277V <input type="radio"/> 120-277V	<input type="radio"/> LED 12W <input type="radio"/> LED 15W <input type="radio"/> LED 20W	<input type="radio"/> 2700K <input type="radio"/> 3000K <input type="radio"/> 3500K <input type="radio"/> 4000K <input type="radio"/> ... <input type="radio"/> RGB <input type="radio"/> RGBW	<input type="radio"/> Cree <input type="radio"/> Citizen <input type="radio"/> Epistar <input type="radio"/> Seoul <input type="radio"/> Osram	<input type="radio"/> Non-Dimmable <input type="radio"/> TRIAC Dimming <input type="radio"/> 0-10V Dimming	<input type="radio"/> White <input type="radio"/> Black <input type="radio"/> Satin Nickel	

* Customized Also Available

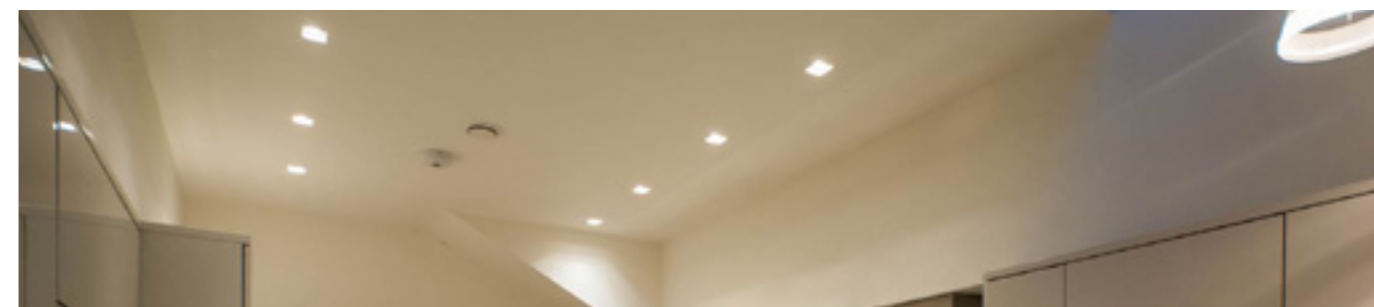

3.5" ROUND COB LED SHALLOW RECESSED DOWNLIGHT KITS

LIGHT SOURCE
COB LED
A35-M-2



Trimless



Trimmed

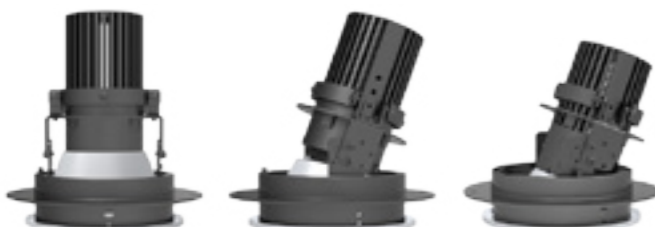

Vertical

Adjustable

Wall Wash

※ Achieve 3 functions through changing screw setting places and replacing matched reflectors.

Mounting Type	Recessed Mount
Wattage	10W
Lumen Efficiency	100lm/W
CRI	80+/90+
CCT	2700K/3000K/3500K/4000K
Input Voltage	AC 120V/277V/120-277V
Power Factor	>0.9
Dimming	None/TRIAC/RD 0-10V Dimming
Location	Insulated Ceiling & Damp Locations
Lifespan	50000 Hours at 70% Light Output
Optics	12°/24°/36°

DESCRIPTION

3.5 inch Shallow LED recessed fixtures with round or square apertures offer energy-efficient, precision lighting for accent, task, or wall wash applications. This dimmable LED recessed light is designed with only a 4-5/8" high housing to easily fit into new construction tight plenums. A feature enriched, small aperture downlight, the innovative design allows the LED to be positioned closer to the aperture for maximum light output and efficiency or higher to minimize glare and flash on the trim. This low profile LED downlight delivers about 950 lumens of award-winning lighting performance while using minimal plenum space. Let your ceilings stand tall, and give them the room they deserve.

FEATURES

Separable rotating reflector design makes it easy for replacement. Provide unique high-low lamp positioning with the simple twist of a screwdriver. Power supply using isolation scheme, driver can achieve high power factor and conversion efficiency, constant current output. Universal 120V-277V driver with optional 0-10V standard dimming protocol.

HOUSING

Heavy duty black powder coated cold roll steel frame. Design for New Construction installation. Standard housing accommodates 1/2" ceiling thickness. Housing types include IC Air-Tight or Non-IC Rated (must specify). Junction box and driver are located on opposite ends of the housing, with easy access for maintenance and installation. Optional round or square aperture shape. Trimless design is available.

OPTICS

12° Spot, 24° Narrow Flood and 36° Flood.

APPLICATIONS

Widely used for commercial and residential applications.

DIMENSIONS

L: 16 9/16"
W: 11 5/16"
H: 4 5/8"
Ø: 4"

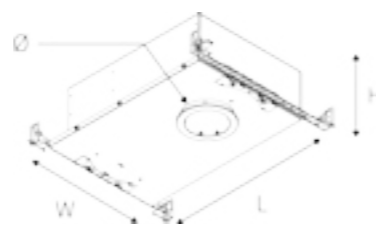

LISTING / WARRANTY

ETL listed to US and Canadian standards for damp location W/Feed through. 5 Years Limited Warranty.



3.5" ROUND COB LED SHALLOW RECESSED DOWNLIGHT KITS

LIGHT DISTRIBUTION CURVE For Wall Wash Lamp

DISTRIBUTION CURVE

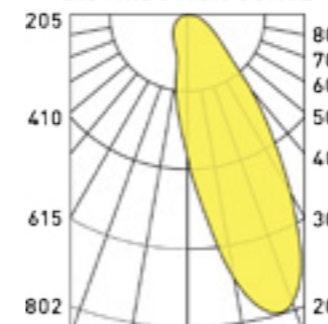

Watts: 15.1
Lumens: 579
LPW: 38
CCT: 3000K
CRI: 82

DISTRIBUTION FROM WALL

DISTANCE FROM CEILING	2' From Wall On 2' Centers			3' From Wall On 2' Centers			3' From Wall On 3' Centers		
	2'	2'	2'	2'	2'	2'	3'	3'	3'
1'	12	12	12	4	4	4	3	3	3
2'	19	20	19	8	8	8	6	7	6
3'	23	25	23	10	11	10	8	9	8
4'	20	22	20	12	13	12	10	11	10
5'	15	16	15	12	13	12	10	11	10
6'	10	11	10	11	12	11	9	10	9
7'	7	8	7	9	9	9	7	8	7
8'	5	5	5	7	7	7	6	6	6
9'	3	4	3	5	5	5	5	5	5
10'	3	3	3	4	4	4	4	4	4
11'	2	2	2	3	3	3	3	3	3
12'	1	1	1	2	2	2	2	2	2

COLOR TEMPERATURE

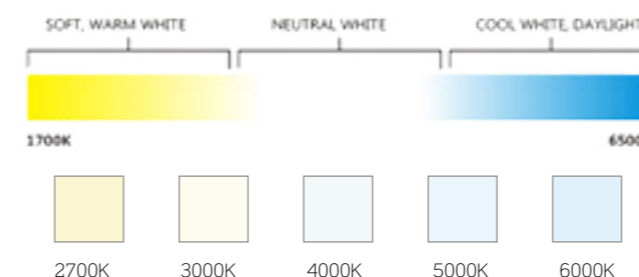

PACKING

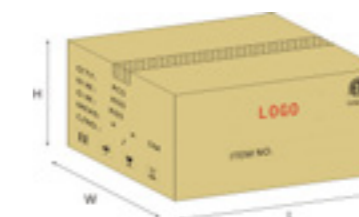

- CTN Size:
L:450xW:400xH:275mm
- Inner Box Size:
L:435xW:385xH:125mm
- 2 PCS/CTN

ORDERING GUIDE / YOUR PRODUCT CODE

SERIES	TRIM	HOUSING TYPE	FRAME	FUNCTIONS	OPTICS	CONTROL SYSTEM
○ A35-M-2 3.5" Downlight	○ TRIMMED ○ TRIMLESS	○ NON-IC ○ IC	○ Butterfly Brackets with C-channel ○ Universal Hanger Bar	○ Vertical Downlight ○ Adjustable Downlight ○ Wall Wash Downlight	○ 12° Spot ○ 24° Narrow Flood ○ 36° Flood	○ 0-10V & 1-10V ○ DMX512 ○ 3CCT (3500K,4500K,6000K) ○ DALI ○ GRPS Control ○ LED Power Controller ○ PLC ○ SCR ○ SPI ○ WIFI ○ ZIGBEE
INPUT VOLTAGE	WATTAGE	CCT	LED AVAILABLE	DIMMABLE	FINISH	
○ 120V ○ 277V ○ 120-277V	○ LED 10W	○ 2700K ○ 3000K ○ 3500K ○ 4000K ○ ... ○ RGB ○ RGBW	○ Cree ○ Citizen ○ Epistar ○ Seoul ○ Osram	○ Non-Dimmable ○ TRIAC Dimming ○ 0-10V Dimming	○ White ○ Black ○ Satin Nickel	

* Customized Also Available

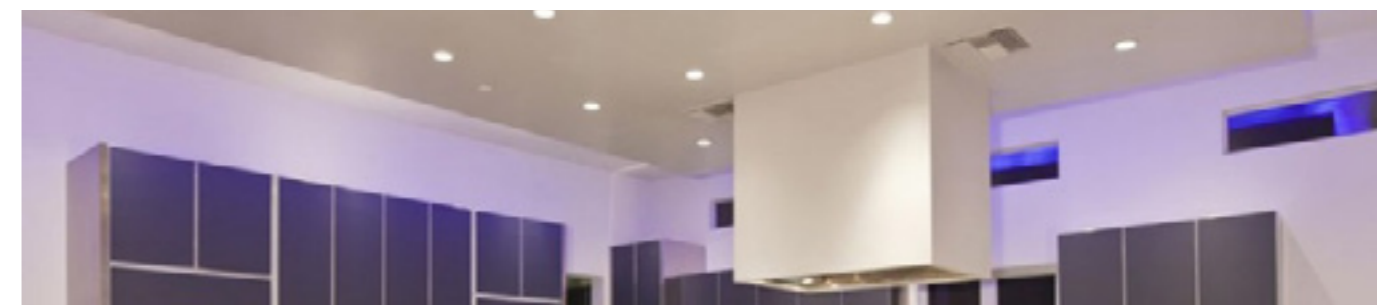

3.5" SQUARE COB LED SHALLOW RECESSED DOWNLIGHT KITS



A35-M-S-2



Trimless

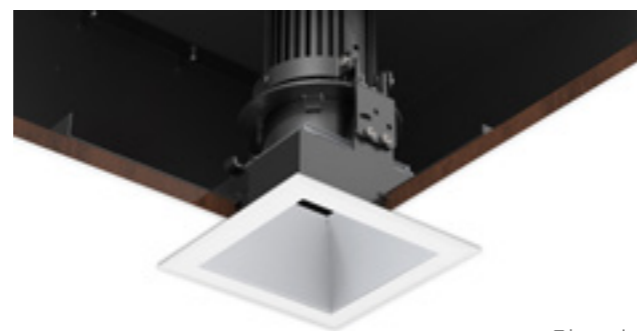

Trimmed

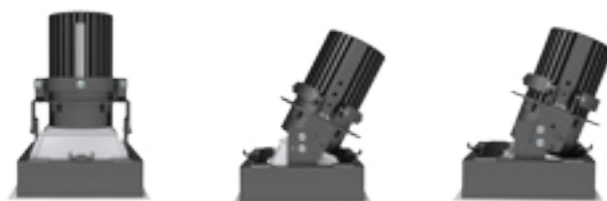

Vertical

Adjustable

Wall Wash

※ Achieve 3 functions through changing screw setting places and replacing matched reflectors.

Mounting Type	Recessed Mount
Wattage	10W
Lumen Efficiency	100lm/W
CRI	80+/90+
CCT	2700K/3000K/3500K/4000K
Input Voltage	AC 120V/277V/120-277V
Power Factor	>0.9
Dimming	None/TRIAC/RD 0-10V Dimming
Location	Insulated Ceiling & Damp Locations
Lifespan	50000 Hours at 70% Light Output
Optics	12°/24°/36°

DESCRIPTION

3.5 inch Shallow LED recessed fixtures with round or square apertures offer energy-efficient, precision lighting for accent, task, or wall wash applications. This dimmable LED recessed light is designed with only a 4-5/8" high housing to easily fit into new construction tight plenums. A feature enriched, small aperture downlight, the innovative design allows the LED to be positioned closer to the aperture for maximum light output and efficiency or higher to minimize glare and flash on the trim. This low profile LED downlight delivers about 950 lumens of award-winning lighting performance while using minimal plenum space. Let your ceilings stand tall, and give them the room they deserve.

FEATURES

Separable rotating reflector design makes it easy for replacement. Provide unique high-low lamp positioning with the simple twist of a screwdriver. Power supply using isolation scheme, driver can achieve high power factor and conversion efficiency, constant current output. Universal 120V-277V driver with optional 0-10V standard dimming protocol.

HOUSING

Heavy duty black powder coated cold roll steel frame. Design for New Construction installation. Standard housing accommodates 1/2" ceiling thickness. Housing types include IC Air-Tight or Non-IC Rated (must specify). Junction box and driver are located on opposite ends of the housing, with easy access for maintenance and installation. Optional round or square aperture shape. Trimless design is available.

OPTICS

12° Spot, 24° Narrow Flood and 36° Flood.

APPLICATIONS

Widely used for commercial and residential applications.

DIMENSIONS

- L: 15 3/8"
- W: 11 5/16"
- H: 4 7/8"
- a: 4 1/16"

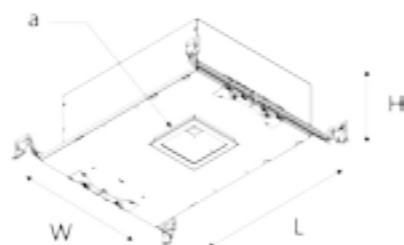

LISTING / WARRANTY

ETL listed to US and Canadian standards for damp location W/Feed through. 5 Years Limited Warranty.



3.5" SQUARE COB LED SHALLOW RECESSED DOWNLIGHT KITS

LIGHT DISTRIBUTION CURVE

For Wall Wash Lamp

DISTRIBUTION CURVE

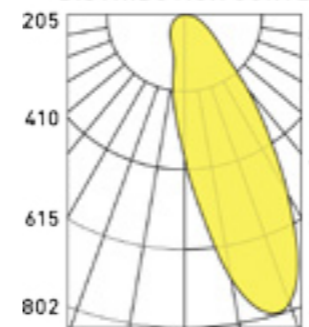

Watts: 15.1
 Lumens: 579
 LPW: 38
 CCT: 3000K
 CRI: 82

DISTRIBUTION FROM WALL

DISTANCE FROM CEILING	2' From Wall On 2' Centers			3' From Wall On 2' Centers			3' From Wall On 3' Centers		
	2'	2'	2'	2'	2'	2'	3'	3'	3'
1'	12	12	12	4	4	4	3	3	3
2'	19	20	19	8	8	8	6	7	6
3'	23	25	23	10	11	10	8	9	8
4'	20	22	20	12	13	12	10	11	10
5'	15	16	15	12	13	12	10	11	10
6'	10	11	10	11	12	11	9	10	9
7'	7	8	7	9	9	9	7	8	7
8'	5	5	5	7	7	7	6	6	6
9'	3	4	3	5	5	5	5	5	5
10'	3	3	3	4	4	4	4	4	4
11'	2	2	2	3	3	3	3	3	3
12'	1	1	1	2	2	2	2	2	2

COLOR TEMPERATURE

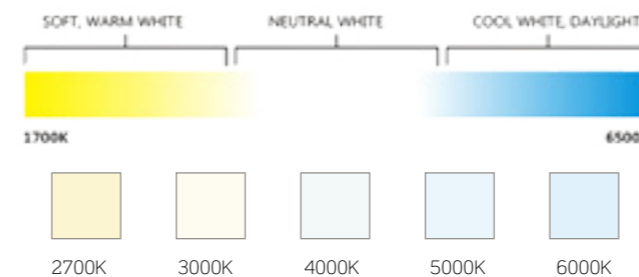

PACKING



- CTN Size: L:450xW:400xH:275mm
- Inner Box Size: L:435xW:385xH:125mm
- 2 PCS/CTN

ORDERING GUIDE / YOUR PRODUCT CODE

SERIES	TRIM	HOUSING TYPE	FRAME	FUNCTIONS	OPTICS	CONTROL SYSTEM
○ A35-M-S-2 3.5" Downlight	○ TRIMMED ○ TRIMLESS	○ NON-IC ○ IC	○ Butterfly Brackets with C-channel ○ Universal Hanger Bar	○ Vertical Downlight ○ Adjustable Downlight ○ Wall Wash Downlight	○ 12° Spot ○ 24° Narrow Flood ○ 36° Flood	○ 0-10V & 1-10V ○ DMX512 ○ 3CCT (3500K,4500K,6000K) ○ DALI ○ GRPS Control ○ LED Power Controller ○ PLC ○ SCR ○ SPI ○ WIFI ○ ZIGBEE
INPUT VOLTAGE	WATTAGE	CCT	LED AVAILABLE	DIMMABLE	FINISH	
○ 120V ○ 277V ○ 120-277V	○ LED 10W	○ 2700K ○ 3000K ○ 3500K ○ 4000K ○ ... ○ RGB ○ RGBW	○ Cree ○ Citizen ○ Epistar ○ Seoul ○ Osram	○ Non-Dimmable ○ TRIAC Dimming ○ 0-10V Dimming	○ White ○ Black ○ Satin Nickel	

* Customized Also Available

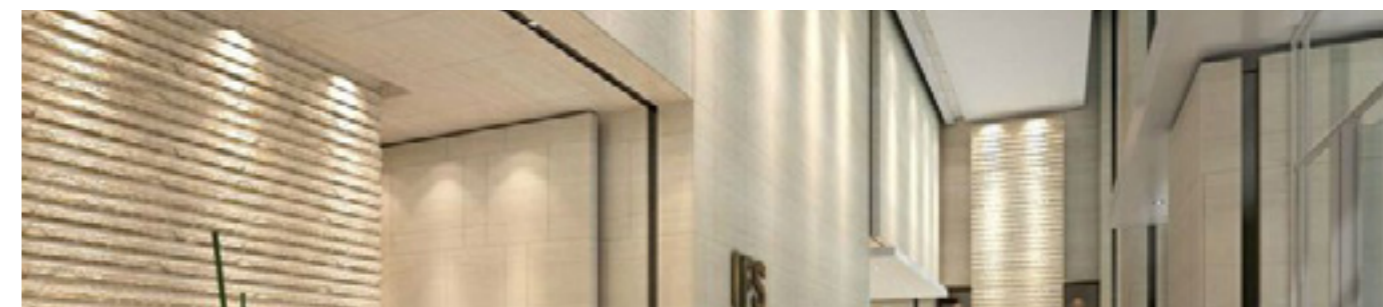

SHALLOW NEW CONSTRUCTION LED DOWNLIGHT

LIGHT SOURCE
COB LED **A3-M-2**



Trimmed

A3-M-2-TL



Trimless

FEATURES

LED Downlights with shallow housings for recessed LED lighting. The finished ceiling is 2 or 3" high and can help you easily combine quality lighting with piping, building infrastructure and electrical equipment in any ventilated space anywhere. Meet the new thinnest LED housing in the world, measuring less than 3" tall from top to bottom. 850 to 1150 delivered lumens, 5 classic white color temperatures (2700K, 3000K, 3500K, 4000K, 5000K). Isolated constant current drive power supply, safe and stable guarantee without strobe, standard dimming control, matching most dimmers. Beam angle: 12/24/36°. Available in trimmed or trimless.

CEILING THICKNESS

Accommodates ceiling thickness 1/2"
Delivered lumens are maintained through entire range

APPLICATIONS

Apply to automotive and parking, education, government, healthcare, hospitality, offices and banks, religious, retail.

LISTING / WARRANTY

ETL listed to US and Canadian standards for damp location W/Feed through. 5 Years Limited Warranty.



DIMMING	80/90	12/15/20W	AC 120V /277V	2700K 3000K 3500K 4000K CCT
---------	-------	-----------	---------------	---

DIMENSIONS

Round Trimmed

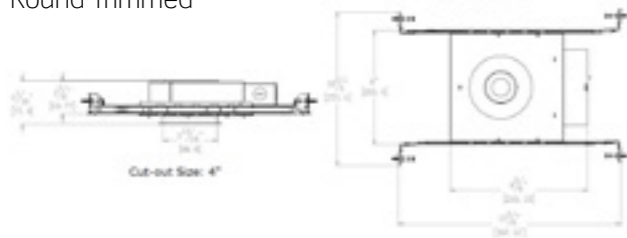

Round Trimless

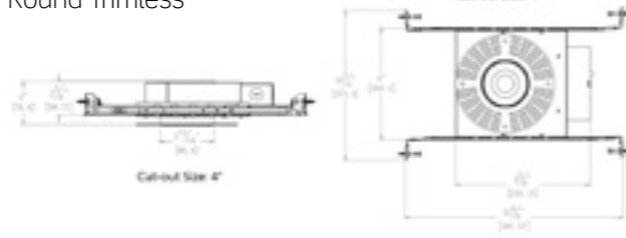

ORDERING GUIDE / YOUR PRODUCT CODE

SERIES/TRIM	WATT	VOLTAGE	CCT	CRI	DIMMING
<input type="radio"/> A3-M-2/Trimmed	<input type="radio"/> 12W	<input type="radio"/> AC 120V	<input type="radio"/> 2700K	<input type="radio"/> 80+	<input type="radio"/> Non-dimming
<input type="radio"/> A3-M-2-TL/Trimless	<input type="radio"/> 15W	<input type="radio"/> AC 277V	<input type="radio"/> 3000K	<input type="radio"/> 90+	<input type="radio"/> TRIAC Dimming
LED Downlight Seires	<input type="radio"/> 20W		<input type="radio"/> 3500K		<input type="radio"/> 0~10V Dimming
			<input type="radio"/> 4000K		

* Other Special Requirements Please Contact with Our Factory



SHALLOW NEW CONSTRUCTION LED DOWNLIGHT

LIGHT SOURCE
COB LED **A3-M-S-2**



Trimmed

A3-M-S-2-TL



Trimless

FEATURES

LED Downlights with shallow housings for recessed LED lighting. The finished ceiling is 2 or 3" high and can help you easily combine quality lighting with piping, building infrastructure and electrical equipment in any ventilated space anywhere. Meet the new thinnest LED housing in the world, measuring less than 3" tall from top to bottom. 850 to 1150 delivered lumens, 5 classic white color temperatures (2700K, 3000K, 3500K, 4000K, 5000K). Isolated constant current drive power supply, safe and stable guarantee without strobe, standard dimming control, matching most dimmers. Beam angle: 12/24/36°. Available in trimmed or trimless.

CEILING THICKNESS

Accommodates ceiling thickness 1/2"
Delivered lumens are maintained through entire range

APPLICATIONS

Apply to automotive and parking, education, government, healthcare, hospitality, offices and banks, religious, retail.

LISTING / WARRANTY

ETL listed to US and Canadian standards for damp location W/Feed through. 5 Years Limited Warranty.



DIMMING	80/90	12/15/20W	AC 120V /277V	2700K 3000K 3500K 4000K CCT
---------	-------	-----------	---------------	---

DIMENSIONS

Square Trimmed

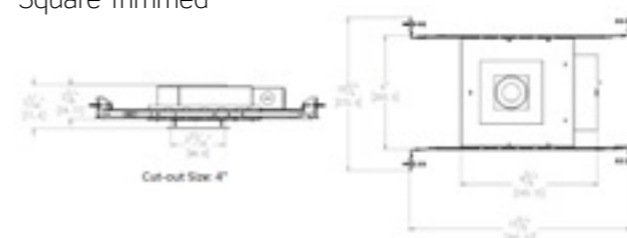

Square Trimless

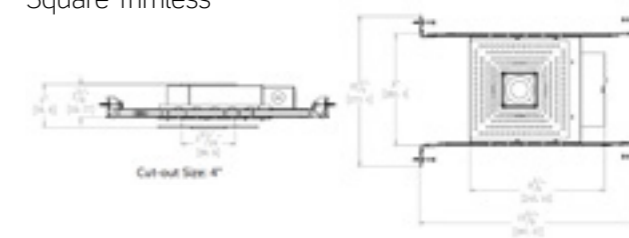

ORDERING GUIDE / YOUR PRODUCT CODE

SERIES/TRIM	WATT	VOLTAGE	CCT	CRI	DIMMING
<input type="radio"/> A3-M-S-2/Trimmed	<input type="radio"/> 12W	<input type="radio"/> AC 120V	<input type="radio"/> 2700K	<input type="radio"/> 80+	<input type="radio"/> Non-dimming
<input type="radio"/> A3-M-S-2-TL/Trimless	<input type="radio"/> 15W	<input type="radio"/> AC 277V	<input type="radio"/> 3000K	<input type="radio"/> 90+	<input type="radio"/> TRIAC Dimming
LED Downlight Seires	<input type="radio"/> 20W		<input type="radio"/> 3500K		<input type="radio"/> 0~10V Dimming
			<input type="radio"/> 4000K		

* Other Special Requirements Please Contact with Our Factory

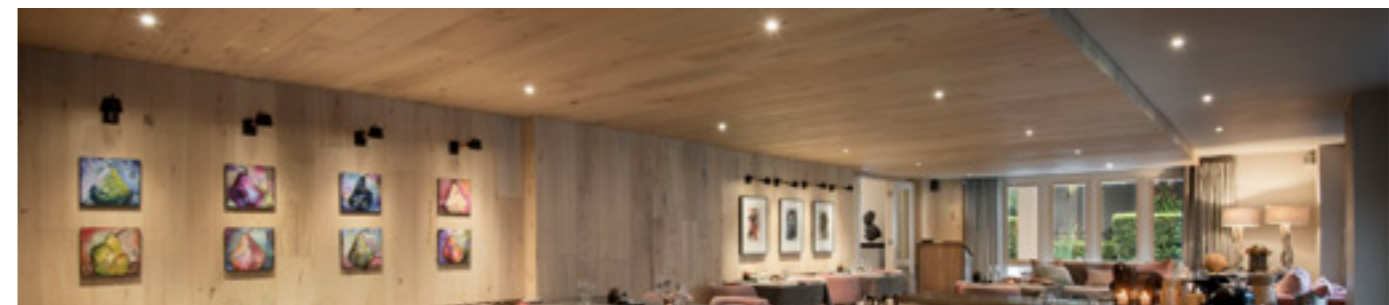

SHALLOW NEW CONSTRUCTION LED DOWNLIGHT

LIGHT SOURCE
COB LED **A3-M-3**

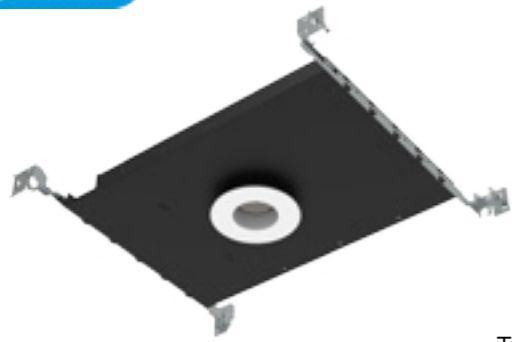

Trimmed

A3-M-3-TL

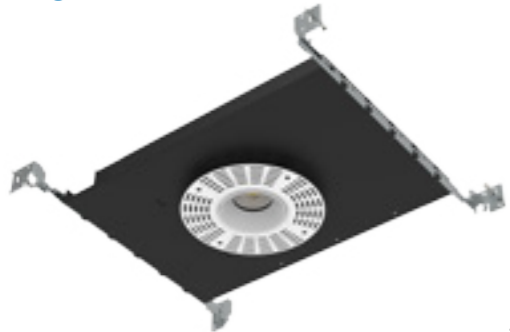

Trimless

FEATURES

LED Downlights with shallow housings for recessed LED lighting. The finished ceiling is 2 or 3" high and can help you easily combine quality lighting with piping, building infrastructure and electrical equipment in any ventilated space anywhere. Meet the new thinnest LED housing in the world, measuring less than 3" tall from top to bottom. 850 to 1150 delivered lumens, 5 classic white color temperatures (2700K, 3000K, 3500K, 4000K, 5000K). Isolated constant current drive power supply, safe and stable guarantee without strobe, standard dimming control, matching most dimmers. Beam angle: 12/24/36°. Available in trimmed or trimless.

CEILING THICKNESS

Accommodates ceiling thickness 1/2"
Delivered lumens are maintained through entire range

APPLICATIONS

Apply to automotive and parking, education, government, healthcare, hospitality, offices and banks, religious, retail.

LISTING / WARRANTY

ETL listed to US and Canadian standards for damp location W/Feed through. 5 Years Limited Warranty.



DIMMING	80/90	12/15/20W	AC 120V /277V	2700K 3000K 3500K 4000K CCT
---------	-------	-----------	---------------	---

DIMENSIONS

Round Trimmed

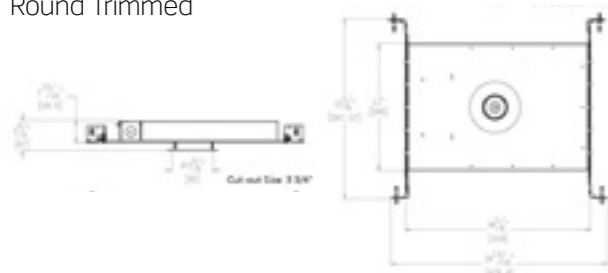

Round Trimless

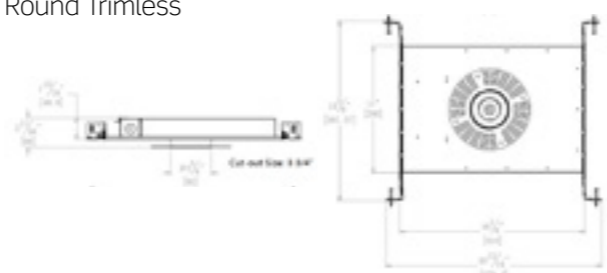

ORDERING GUIDE / YOUR PRODUCT CODE

SERIES/TRIM	WATT	VOLTAGE	CCT	CRI	DIMMING
<input type="radio"/> A3-M-3/Trimmed	<input type="radio"/> 12W	<input type="radio"/> AC 120V	<input type="radio"/> 2700K	<input type="radio"/> 80+	<input type="radio"/> Non-dimming
<input type="radio"/> A3-M-3-TL/Trimless	<input type="radio"/> 15W	<input type="radio"/> AC 277V	<input type="radio"/> 3000K	<input type="radio"/> 90+	<input type="radio"/> TRIAC Dimming
LED Downlight Seires		<input type="radio"/> 20W	<input type="radio"/> 3500K		<input type="radio"/> 0~10V Dimming
			<input type="radio"/> 4000K		

* Other Special Requirements Please Contact with Our Factory

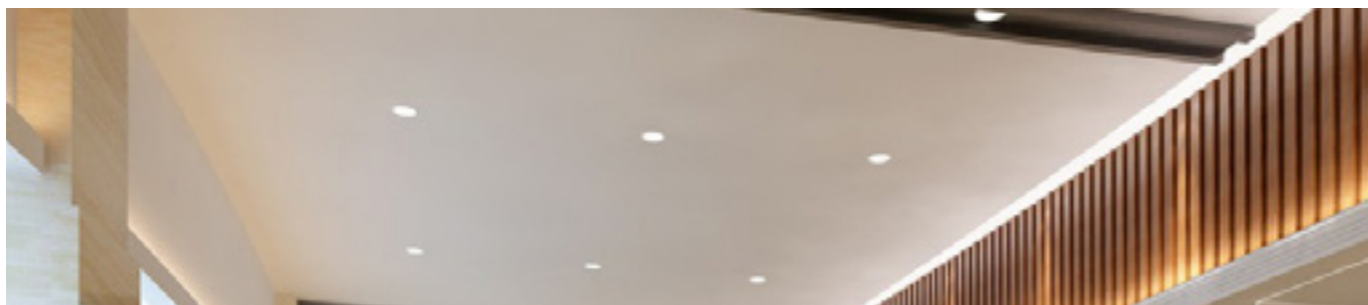

SHALLOW NEW CONSTRUCTION LED DOWNLIGHT

LIGHT SOURCE
COB LED **A3-M-S-3**

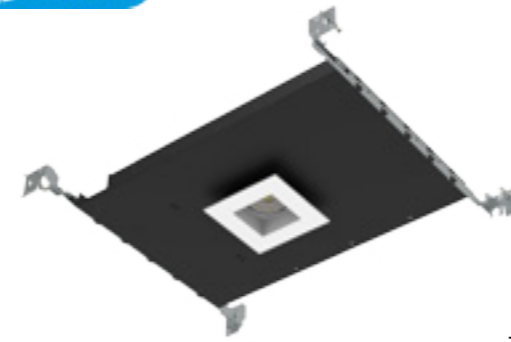

Trimmed

A3-M-S-3-TL

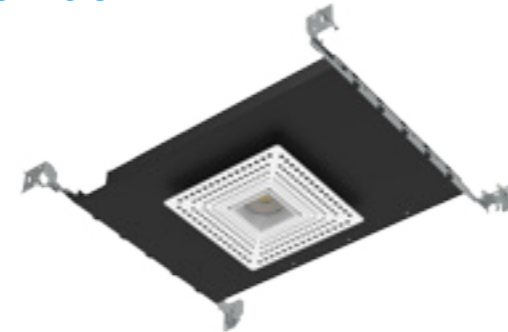

Trimless

FEATURES

LED Downlights with shallow housings for recessed LED lighting. The finished ceiling is 2 or 3" high and can help you easily combine quality lighting with piping, building infrastructure and electrical equipment in any ventilated space anywhere. Meet the new thinnest LED housing in the world, measuring less than 3" tall from top to bottom. 850 to 1150 delivered lumens, 5 classic white color temperatures (2700K, 3000K, 3500K, 4000K, 5000K). Isolated constant current drive power supply, safe and stable guarantee without strobe, standard dimming control, matching most dimmers. Beam angle: 12/24/36°. Available in trimmed or trimless.

CEILING THICKNESS

Accommodates ceiling thickness 1/2"
Delivered lumens are maintained through entire range

APPLICATIONS

Apply to automotive and parking, education, government, healthcare, hospitality, offices and banks, religious, retail.

LISTING / WARRANTY

ETL listed to US and Canadian standards for damp location W/Feed through. 5 Years Limited Warranty.



DIMMING	80/90	12/15/20W	AC 120V /277V	2700K 3000K 3500K 4000K CCT
---------	-------	-----------	---------------	---

DIMENSIONS

Square Trimmed

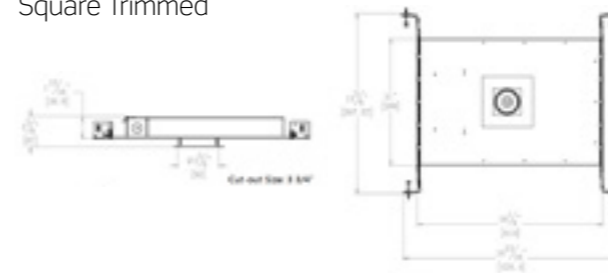

Square Trimless

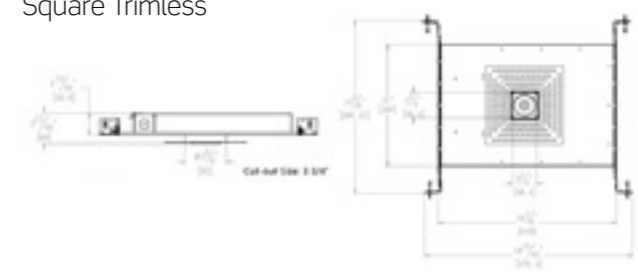

ORDERING GUIDE / YOUR PRODUCT CODE

SERIES/TRIM	WATT	VOLTAGE	CCT	CRI	DIMMING
<input type="radio"/> A3-M-S-3/Trimmed	<input type="radio"/> 12W	<input type="radio"/> AC 120V	<input type="radio"/> 2700K	<input type="radio"/> 80+	<input type="radio"/> Non-dimming
<input type="radio"/> A3-M-S-3-TL/Trimless	<input type="radio"/> 15W	<input type="radio"/> AC 277V	<input type="radio"/> 3000K	<input type="radio"/> 90+	<input type="radio"/> TRIAC Dimming
LED Downlight Seires		<input type="radio"/> 20W	<input type="radio"/> 3500K		<input type="radio"/> 0~10V Dimming
			<input type="radio"/> 4000K		

* Other Special Requirements Please Contact with Our Factory

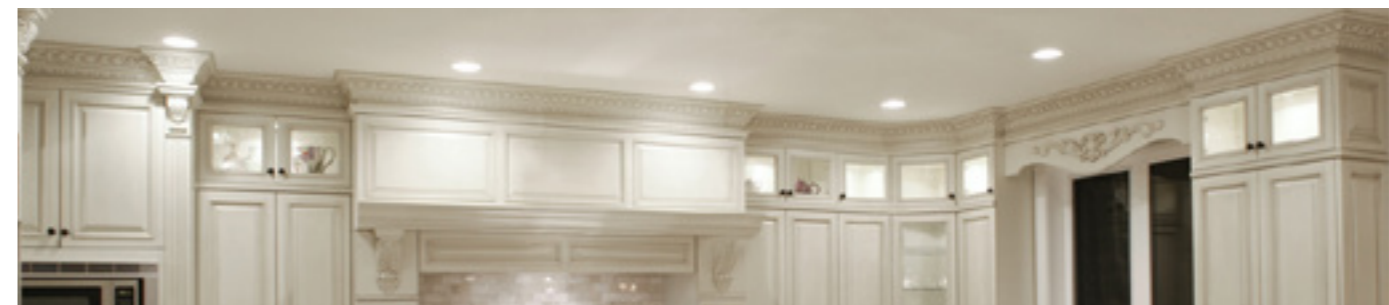

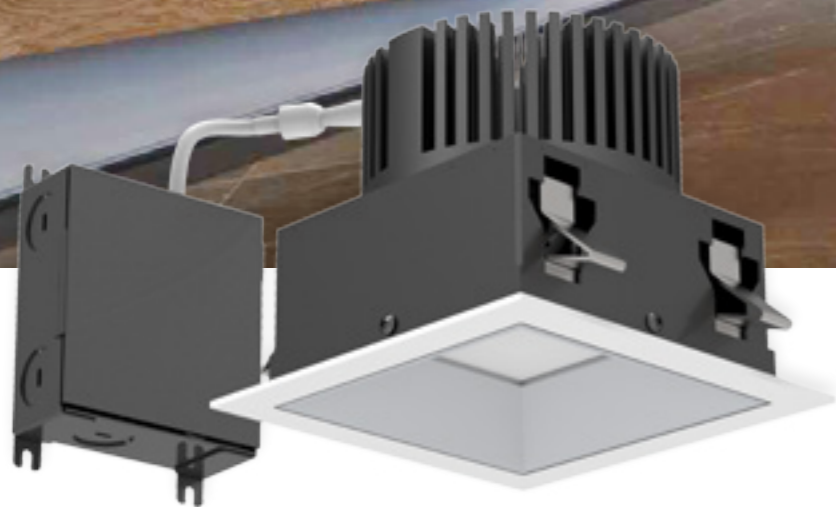

COMMERCIAL DOWNLIGHT

ADJUSTABLE LED RECESSED DOWNLIGHT

Liteharbor commercial LED recessed downlight, flexible adjustable design for different ceiling thickness. This commercial LED solution provides soft lighting without seeing the light source, ideal for commercial and architectural lighting applications.

4 INCH TRIMMED ROUND SHAPE LED RECESSED DOWNLIGHT

AL4-R-002



FEATURES

This is a 4 inch 20W IC rated downlight, the product is light and thin. It is a high performance, easy to install residential grade downlight, providing good light output, the light evenly soft, energy efficient; Double color temperature design, by switching the switch to convert different color temperature. Using two clips installation, easy to install without tools and save time. Can be adapted to the 1/2 "to 1 1/4" ceiling. 30° large shading angle, excellent light concealment, no glare, achieve soft lighting without seeing the light source, it can effectively protect the vision and highlight the space effect.

SPECIFICATIONS

Radiator: Using cold forging radiator, fast heat dissipation, good effect, effectively ensure the service life of the lamp.
Accessory: Using the iron spinning process, can electroplate or spray of high reflective powder, elegant appearance .
LED Chips: Using high brightness chip, superior performance, durable and stable, even illumination, retain color for long time, life rated for 36,000 hours at 70% lumen maintenance, low light failure and long life.
FT4 line fast connection terminal: With anti-pull device, safe and reliable and easy to install.

APPLICATIONS

Apply to automotive and parking, education, government, healthcare, hospitality, offices and banks, religious, retail.

LISTING / WARRANTY

ETL listed to US and Canadian standards for damp location W/Feed through. 5 Years Limited Warranty.



DRIVER

Independent constant current isolation drive, optional high power factor. Constant current design, high reliability and stable performance. Products meet the requirements of safety regulations and electromagnetic compatibility.

DIMENSIONS



ORDERING GUIDE / YOUR PRODUCT CODE

SERIES	WATT	LUMEN	CCT	DIMMABLE	FINISH
<input type="radio"/> AL4-R-002 LED Recessed Downlight	<input type="radio"/> 20W Max.	<input type="radio"/> 1600lm Max.	<input type="radio"/> 2700K <input type="radio"/> 3000K <input type="radio"/> 3500K <input type="radio"/> 4000K	<input type="radio"/> Non-Dimming <input type="radio"/> TRIAC Dimming	<input type="radio"/> White <input type="radio"/> Black

* Customized Also Available

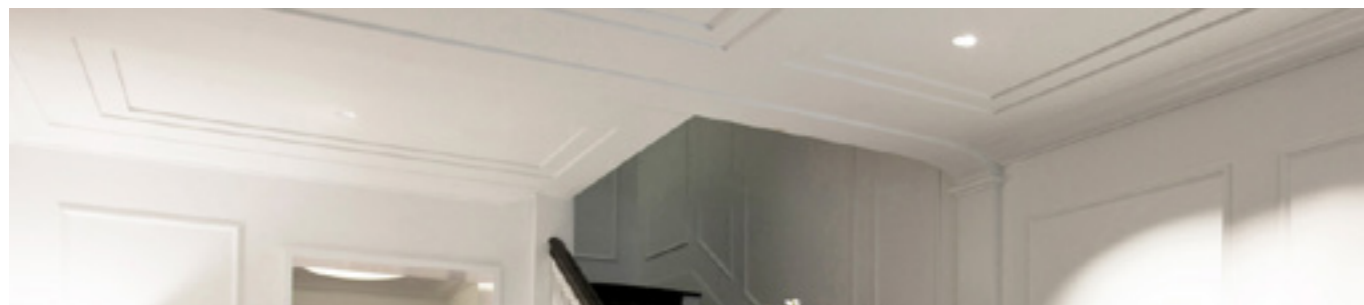

4 INCH TRIMLESS ROUND SHAPE LED RECESSED DOWNLIGHT

AL4-R-002-TL



FEATURES

This is a 4 inch 20W IC rated downlight, the product is light and thin. It is a high performance, easy to install residential grade downlight, providing good light output, the light evenly soft, energy efficient; Double color temperature design, by switching the switch to convert different color temperature. Using two clips installation, easy to install without tools and save time. Can be adapted to the 1/2 "to 1 1/4" ceiling. 30° large shading angle, excellent light concealment, no glare, achieve soft lighting without seeing the light source, it can effectively protect the vision and highlight the space effect.

SPECIFICATIONS

Radiator: Using cold forging radiator, fast heat dissipation, good effect, effectively ensure the service life of the lamp.
Accessory: Using the iron spinning process, can electroplate or spray of high reflective powder, elegant appearance .
LED Chips: Using high brightness chip, superior performance, durable and stable, even illumination, retain color for long time, life rated for 36,000 hours at 70% lumen maintenance, low light failure and long life.
FT4 line fast connection terminal: With anti-pull device, safe and reliable and easy to install.

APPLICATIONS

Apply to automotive and parking, education, government, healthcare, hospitality, offices and banks, religious, retail.

LISTING / WARRANTY

ETL listed to US and Canadian standards for damp location W/Feed through. 5 Years Limited Warranty.



DRIVER

Independent constant current isolation drive, optional high power factor. Constant current design, high reliability and stable performance. Products meet the requirements of safety regulations and electromagnetic compatibility.

DIMENSIONS



ORDERING GUIDE / YOUR PRODUCT CODE

SERIES	WATT	LUMEN	CCT	DIMMABLE	FINISH
<input type="radio"/> AL4-R-002-TL LED Recessed Downlight	<input type="radio"/> 20W Max.	<input type="radio"/> 1600lm Max.	<input type="radio"/> 2700K <input type="radio"/> 3000K <input type="radio"/> 3500K <input type="radio"/> 4000K	<input type="radio"/> Non-Dimming <input type="radio"/> TRIAC Dimming	<input type="radio"/> White <input type="radio"/> Black

* Customized Also Available

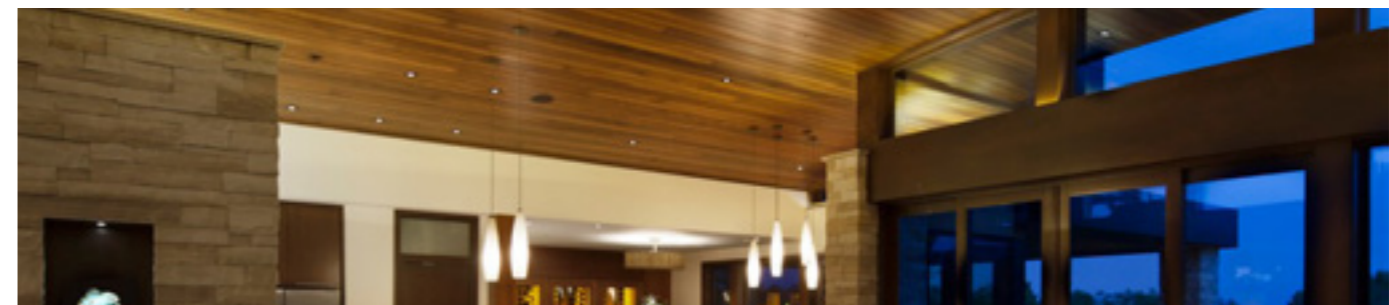

4" REMODEL ADJUSTABLE SQUARE LED RECESSED DOWNLIGHT

LIGHT SOURCE COB LED **AL4-R**

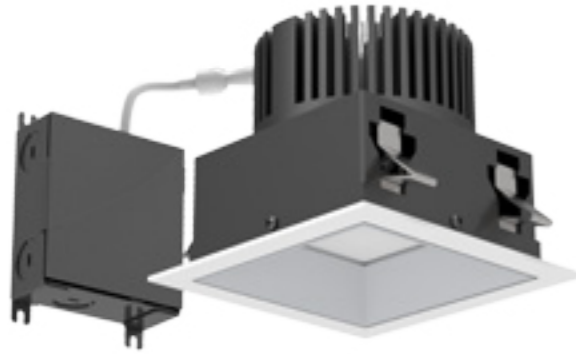

DESCRIPTION

Lamp height can be adjusted, accommodate 1/2" to 1 1/4" ceiling thickness. Trimmed and trimless available. Rotated separated reflector, more convenient for parts replacement. Isolation driver, high power factor and conversion efficiency, constant current output. Application: Automotive and Parking, Education, Government, Healthcare, Hospitality, Offices and Banks, Religious, Retail.

TRIM

Die-casting aluminum, high-reflective powder spraying, high light uniformity.

LIGHT SOURCE

High light transmittance, strong light diffusion performance, no shadow, no glare. Point light source emitting turned into spherical light emitting. Milky white light transmission rate reach 90% above. Excellent concealed light source, achieve the best light transmission rate without seeing the LED lamp bead.

RADIATOR

Excellent cold forging radiator, good heat dissipation.

LISTING / WARRANTY

ETL listed to US and Canadian standards for damp location W/Feed through. 5 Years Limited Warranty.



--	--	--	--	--

DIMENSIONS

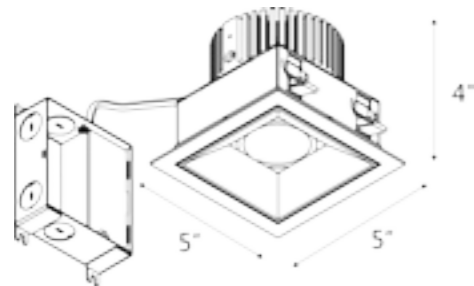

TRIM OPTION

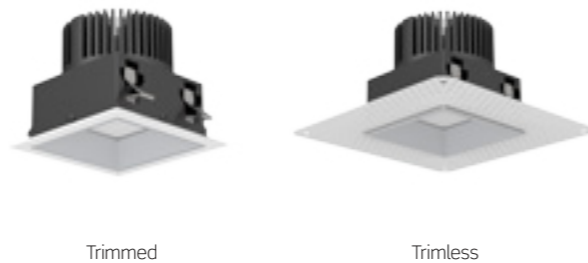

Trimmed

Trimless

ORDERING GUIDE / YOUR PRODUCT CODE

SERIES	TRIM	INPUT VOLTAGE	POWER/LUMEN	CCT	DIMMABLE	FINISH
AL4-R 4" Adjustable LED Downlight	Trimmed	120V	15W / 1000LM	2700K	NONE	White
		277V	20W / 1500LM	3000K	TRIAC	Black
	Trimless	120-277V	30W / 2250LM	3500K	RD 0-10V	Satin Nickel
				4000K		Clear

* Customized Also Available

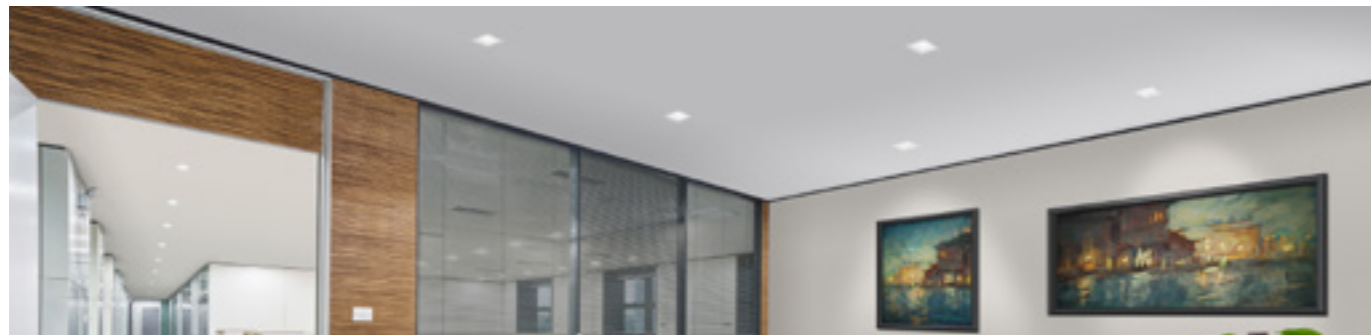

NEW CONSTRUCTION ADJUSTABLE SQUARE LED RECESSED DOWNLIGHT

LIGHT SOURCE COB LED **AL4-NC**



※ Square and Round Items share one mounting plate of round aperture.

DESCRIPTION

4-way hanger bar install, the hanger bar can be adjusted from 14 1/2"-24", to adapt to a variety of joist structures and keel sizes. Lamp height can be adjusted, accommodate 1/2" to 1 1/4" ceiling thickness. Trimmed and trimless available. Rotated separated reflector, more convenient for parts replacement. Isolation driver, high power factor and conversion efficiency, constant current output. Square new construction bottom plate can adjust 45°, suitable for special occasions. 4" and 6", square and round new construction share the same bottom plate. Different opening accessories, for fast replacement.

TRIM

Die-casting aluminum, high-reflective powder spraying, high light uniformity.

LIGHT SOURCE

High light transmittance, strong light diffusion performance, no shadow, no glare. Point light source emitting turned into spherical light emitting. Milky white light transmission rate reach 90% above. Excellent concealed light source, achieve the best light transmission rate without seeing the LED lamp bead.

RADIATOR

Excellent cold forging radiator, good heat dissipation.

LISTING / WARRANTY

ETL listed to US and Canadian standards for damp location W/Feed through. 5 Years Limited Warranty.



--	--	--	--	--

DIMENSIONS

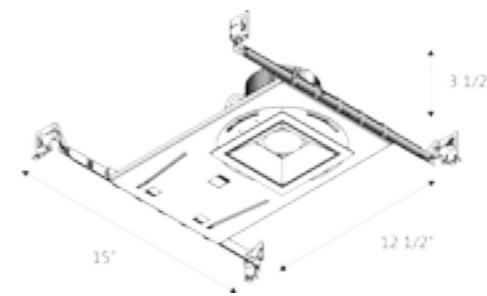

TRIM OPTION

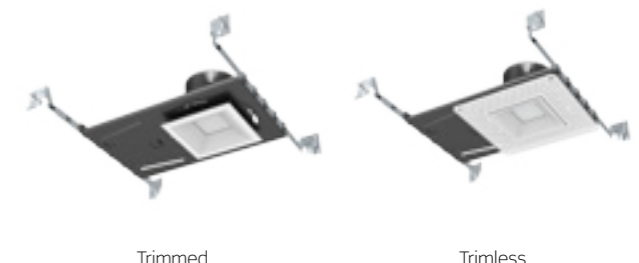

Trimmed

Trimless

ORDERING GUIDE / YOUR PRODUCT CODE

SERIES	TRIM	INPUT VOLTAGE	POWER/LUMEN	CCT	DIMMABLE	FINISH
AL4-NC 4" Adjustable LED Downlight	Trimmed	120V	15W / 1000LM	2700K	NONE	White
		277V	20W / 1500LM	3000K	TRIAC	Black
	Trimless	120-277V	30W / 2250LM	3500K	RD 0-10V	Satin Nickel
				4000K		Clear

* Customized Also Available





LED DOWNLIGHT

LED RETROFIT DOWNLIGHT

ARCHITECTURAL RECESSED DOWNLIGHT

The Architectural Downlighting Series delivers on Liteharbor Lighting's commitment to quality and value. With a wide selection of housings, trims and lamp options, the architectural series conforms to any commercial application. Downlights in series are available in 4, 6 and 8 inch aperture and new standard for all reflectors.

4" ARCHITECTURAL LED DOWNLIGHT

LIGHT SOURCE
COB LED **AL4-VA**



DESCRIPTION

Lighting is smooth and comfortable while using 50% less energy than the common CFL downlight. Eco-friendly no lead or mercury. Designed to install into an existing downlights mounting frame and convert them into energy efficient LED downlights to save anywhere from 35% up to 75% on energy cost. Ideal suited for use in commercial, retail and other architectural applications. Available with dedicated Emergency Battery Back-up.

ELECTRICAL SYSTEM

Thermal protection guard protects the LED module from overheating and will dim LED module if necessary.

JUNCTION BOX

Plaster frame integrated 29 cubic inch 0.064" thick galvanized steel. Provided with four 1/2" knockouts, one 3/4" knockout and four Romex knockouts with true pryout slots and strain clamps. Designed for straight through conduit runs. Electrical connections are made through a single junction box door. Green wire provided for installation with ground wire fed through PVC pipe conduit.

MOUNTING

Designed to install into an existing downlights mounting frame and convert them into energy efficient LED downlights. Flex is designed to attach into existing junction box. Vertically adjustable universal mounting brackets accept flat bar hangers, conduit or C channel. The reflector assembly is held in with 4 "butter-fly" spring clips. Reflector assembly quickly attaches with lockable quick connect Hanger bars ordered separately. Compatible with C-channel, flat bar wood joist bar hanger and EMT.

DRIVER

The LED driver is mounted to the J-box cover and is accessible from below the ceiling. Rated for 50Hz to 60Hz at 120V/277V input. Produces less than 20% THD.

LISTING / WARRANTY

ETL listed to US and Canadian standards for damp location W/Feed through. 5 Years Limited Warranty.



DIMMING	80/90 LED CRI	120V 277V Input Voltage	11W 15W 18W 25W Wattage	900Lm 1200Lm 1500Lm 2500Lm Lumen	2700K 3000K 3500K 4000K CCT
---------	---------------	-------------------------	-------------------------	----------------------------------	-----------------------------

DIMENSIONS

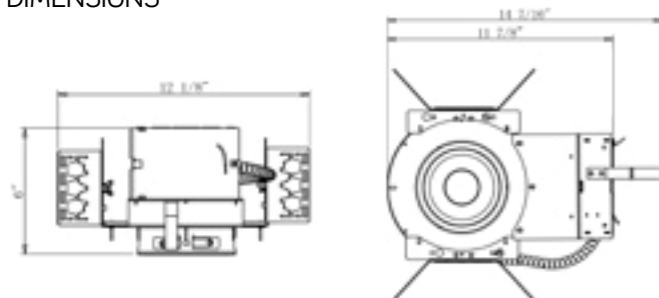

ORDERING GUIDE / YOUR PRODUCT CODE

SERIES	INPUT VOLTAGE	LED AVAILABLE	WATTAGE / LUMEN	CCT	OPTIONS	TRIM	LENS TYPE	Finish
AL4-VA 4" Architectural Downlight	120V	Cree	11W / 900 Lm	2700K	Emergency Backup	Self Flanged	Clear Tempered	Clear
	277V	Citizen	15W / 1200 Lm	3000K	C-Channel Bar Hanger	Self Flanged White	Sand Blasted	Haze
	120-277V	Epistar	18W / 1500 Lm	3500K	Flat Bar Hanger	NO Flange		White
	DIMMABLE		Seoul	25W / 2000 Lm	4000K	Wood Joist Bar Hanger		
		Osram						
		Non-Dimmable						
		Dimmable						

* Customized Also Available

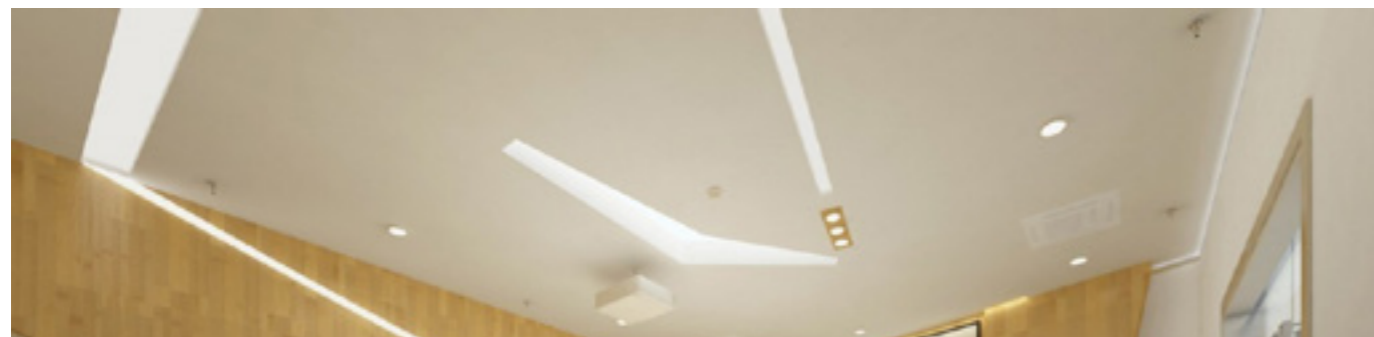

4" ARCHITECTURAL LED RETROFIT DOWNLIGHT

LIGHT SOURCE
COB LED **BL4-001-R**



DESCRIPTION

Lighting is smooth and comfortable while using 50% less energy than the common CFL downlight. Eco-friendly no lead or mercury. Designed to install into an existing downlights mounting frame and convert them into energy efficient LED downlights to save anywhere from 35% up to 75% on energy cost. Ideal suited for use in commercial, retail and other architectural applications. Available with dedicated Emergency Battery Back-up.

ELECTRICAL SYSTEM

Thermal protection guard protects the LED module from overheating and will dim LED module if necessary.

CLEARANCE

Frames require a minimum clearance of 3" ring from thermal insulation and 1/2" from adjacent building component.

MOUNTING

Designed to install into an existing downlights mounting frame and convert them into energy efficient LED downlights. Flex is designed to attach into existing junction box. Vertically adjustable universal mounting brackets accept flat bar hangers, conduit or C channel. The reflector assembly is held in with 4 "butter-fly" spring clips. Reflector assembly quickly attaches with lockable quick connect Hanger bars ordered separately. Compatible with C-channel, flat bar wood joist bar hanger and EMT.

DIMMING	80/90 LED CRI	120V 277V Input Voltage	11W 15W 18W 25W Wattage	900Lm 1200Lm 1500Lm 2500Lm Lumen	2700K 3000K 3500K 4000K CCT
---------	---------------	-------------------------	-------------------------	----------------------------------	-----------------------------

DIMENSIONS

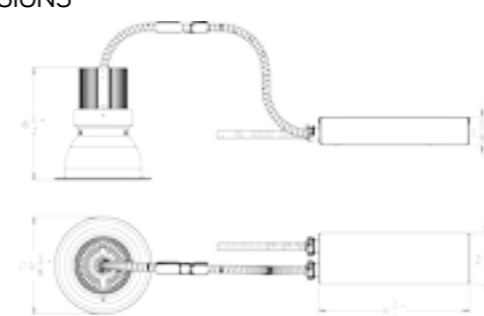

ORDERING GUIDE / YOUR PRODUCT CODE

SERIES	INPUT VOLTAGE	DIMMABLE	LED AVAILABLE	WATTAGE / LUMEN	CCT	TRIM	LENS TYPE	Finish
BL-4001-R 4" ARCHITECTURAL RETROFIT DOWNLIGHT	120V	Non-Dimmable	Cree	11W / 900 Lm	2700K	Self Flanged	Clear Tempered	Clear
	277V	Dimmable	Citizen	15W / 1200 Lm	3000K	Self Flanged White	Sand Blasted	Haze
	120-277V		Epistar	18W / 1500 Lm	3500K	NO Flange		White
			Seoul	25W / 2000 Lm	4000K			
		Osram						

* Customized Also Available



6" ARCHITECTURAL LED DOWNLIGHT

AL6-VA
LIGHT SOURCE
COB LED



DESCRIPTION

Lighting is smooth and comfortable while using 50% less energy than the common CFL downlight.
Eco-friendly no lead or mercury
Designed to install into an existing downlights mounting frame and convert them into energy efficient LED downlights to save anywhere from 35% up to 75% on energy cost.
Ideal suited for use in commercial, retail and other architectural applications
Available with dedicated emergency battery Back-up

ELECTRICAL SYSTEM

Thermal protection guard protects the LED module from overheating and will dim LED module if necessary

JUNCTION BOX

Plaster frame integrated 29 cubic inch 0.064" thick galvanized steel
Provided with four 1/2" knockouts, one 3/4" knockout and four Romex knockouts with true pryout slots and strain clamps.
Designed for straight through conduit runs.
Electrical connections are made through a single junction box door.
Green wire provided for installation with ground wire fed through PVC pipe conduit.

MOUNTING

Designed to install into an existing downlights mounting frame and convert them into energy efficient LED downlights.
Flex is designed to attach into existing junction box.
Vertically adjustable universal mounting brackets accept flat bar hangers, conduit or C channel.
The reflector assembly is held in with 4 "butter-fly" spring clips.
Reflector assy quickly attaches with lockable quick connect hanger bars ordered separately.
Compatible with C-channel, flat bar wood joist bar hanger and EMT

DRIVER

The LED driver is mounted to the J-box cover and is accessible from below the ceiling.
Rated for 50Hz to 60Hz at 120V/277V input
Produces less than 20% THD

LISTING / WARRANTY

ETL listed to US and Canadian standards for damp location W/Feed through.
5 Years Limited Warranty.



	80/90 LED CRI	120V 277V Input Voltage	20W 25W 30W Wattage	1600Lm 2000Lm 2400Lm Lumen	2700K 3000K 3500K 4000K CCT
--	------------------	-------------------------------	------------------------------	-------------------------------------	---

DIMENSIONS

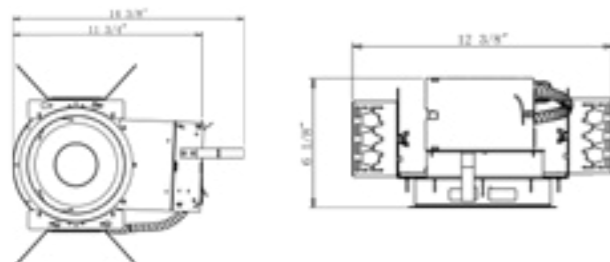

ORDERING GUIDE / YOUR PRODUCT CODE

SERIES	INPUT VOLTAGE	LED AVAILABLE	WATTAGE / LUMEN	CCT	OPTIONS	TRIM	LENS TYPE	FINISH
AL6-VA 6" Architectural Downlight	<input type="radio"/> 120V	<input type="radio"/> Cree	<input type="radio"/> 20W / 1600 Lm	<input type="radio"/> 2700K	<input type="radio"/> Emergency Backup	<input type="radio"/> Self Flanged	<input type="radio"/> Clear Tempered	<input type="radio"/> Clear
	<input type="radio"/> 277V	<input type="radio"/> Citizen	<input type="radio"/> 25W / 2000 Lm	<input type="radio"/> 3000K	<input type="radio"/> C-Channel Bar Hanger	<input type="radio"/> Self Flanged White	<input type="radio"/> Sand Blasted	<input type="radio"/> Haze
	<input type="radio"/> 120-277V	<input type="radio"/> Epistar	<input type="radio"/> 30W / 2400 Lm	<input type="radio"/> 3500K	<input type="radio"/> Flat Bar Hanger	<input type="radio"/> NO Flange		<input type="radio"/> White
	<input type="radio"/> DIMMABLE	<input type="radio"/> Seoul		<input type="radio"/> 4000K	<input type="radio"/> Wood Joist Bar Hanger			
	<input type="radio"/> Non-Dimmable	<input type="radio"/> Osram						
	<input type="radio"/> Dimmable							

* Customized Also Available

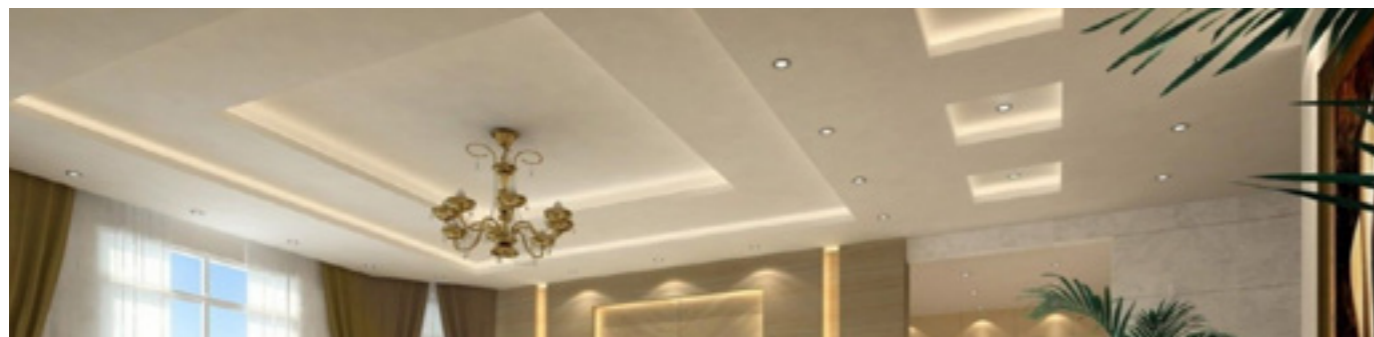

6" ARCHITECTURAL LED RETROFIT DOWNLIGHT

BL6-001-R
LIGHT SOURCE
COB LED



DESCRIPTION

Lighting is smooth and comfortable while using 50% less energy than the common CFL downlight.
Eco-friendly no lead or mercury
Designed to install into an existing downlights mounting frame and convert them into energy efficient LED downlights to save anywhere from 35% up to 75% on energy cost.
Ideal suited for use in commercial, retail and other architectural applications
Available with dedicated Emergency Battery Back-up

ELECTRICAL SYSTEM

Thermal protection guard protects the LED module from overheating and will dim LED module if necessary

CLEARANCE

Frames require a minimum clearance of 3" ring from thermal insulation and 1/2" from adjacent building component.

MOUNTING

Designed to install into an existing downlights mounting frame and convert them into energy efficient LED downlights.
Flex is designed to attach into existing junction box.
Vertically adjustable universal mounting brackets accept flat bar hangers, conduit or C channel.
The reflector assembly is held in with 4 "butter-fly" spring clips.
Reflector assy quickly attaches with lockable quick connect Hanger bars ordered separately.
Compatible with C-channel, flat bar wood joist bar hanger and EMT

LISTING / WARRANTY

ETL listed to US and Canadian standards for damp location W/Feed through.
5 Years Limited Warranty.



	80/90 LED CRI	120V 277V Input Voltage	20W 25W 30W Wattage	1600Lm 2000Lm 2400Lm Lumen	2700K 3000K 3500K 4000K CCT
--	------------------	-------------------------------	------------------------------	-------------------------------------	---

DIMENSIONS



ORDERING GUIDE / YOUR PRODUCT CODE

SERIES	INPUT VOLTAGE	DIMMABLE	LED AVAILABLE	WATTAGE / LUMEN	CCT	TRIM	LENS TYPE	Finish
BL6-001-R 6" ARCHITECTURAL RETROFIT DOWNLIGHT	<input type="radio"/> 120V	<input type="radio"/> Non-Dimmable	<input type="radio"/> Cree	<input type="radio"/> 20W / 1600 Lm	<input type="radio"/> 2700K	<input type="radio"/> Self Flanged	<input type="radio"/> Clear Tempered	<input type="radio"/> Clear
	<input type="radio"/> 277V	<input type="radio"/> Dimmable	<input type="radio"/> Citizen	<input type="radio"/> 25W / 2000 Lm	<input type="radio"/> 3000K	<input type="radio"/> Self Flanged White	<input type="radio"/> Sand Blasted	<input type="radio"/> Haze
	<input type="radio"/> 120-277V		<input type="radio"/> Epistar	<input type="radio"/> 30W / 2400 Lm	<input type="radio"/> 3500K	<input type="radio"/> NO Flange		<input type="radio"/> White
			<input type="radio"/> Seoul		<input type="radio"/> 4000K			
			<input type="radio"/> Osram					

* Customized Also Available

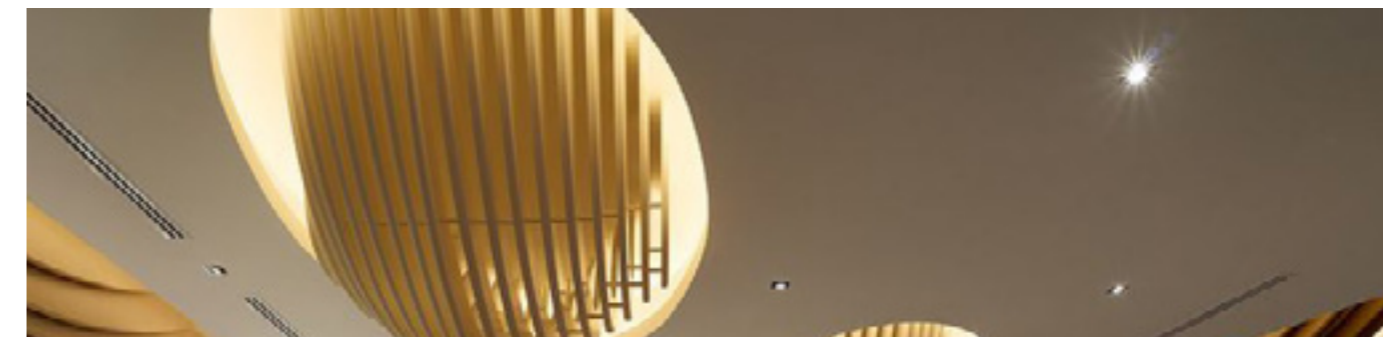

8" ARCHITECTURAL LED DOWNLIGHT

LIGHT SOURCE
COB LED **AL8-VA**



DESCRIPTION

Lighting is smooth and comfortable while using 50% less energy than the common CFL downlight. Eco-friendly no lead or mercury. Designed to install into an existing downlights mounting frame and convert them into energy efficient LED downlights to save anywhere from 35% up to 75% on energy cost. Ideal suited for use in commercial, retail and other architectural applications. Available with dedicated Emergency Battery Back-up.

ELECTRICAL SYSTEM

Thermal protection guard protects the LED module from overheating and will dim LED module if necessary.

JUNCTION BOX

Plaster frame integrated 29 cubic inch 0.064" thick galvanized steel. Provided with four 1/2" knockouts, one 3/4" knockout and four Romex knockouts with true pryout slots and strain clamps. Designed for straight through conduit runs. Electrical connections are made through a single junction box door. Green wire provided for installation with ground wire fed through PVC pipe conduit.

MOUNTING

Designed to install into an existing downlights mounting frame and convert them into energy efficient LED downlights. Flex is designed to attach into existing junction box. Vertically adjustable universal mounting brackets accept flat bar hangers, conduit or C channel. The reflector assembly is held in with 4 "butter-fly" spring clips. Reflector assy quickly attaches with lockable quick connect Hanger bars ordered separately. Compatible with C-channel, flat bar wood joist bar hanger and EMT.

DRIVER

The LED driver is mounted to the J-box cover and is accessible from below the ceiling. Rated for 50Hz to 60Hz at 120V/277V input. Produces less than 20% THD.

LISTING / WARRANTY

ETL listed to US and Canadian standards for damp location W/Feed through. 5 Years Limited Warranty.



DIMENSIONS

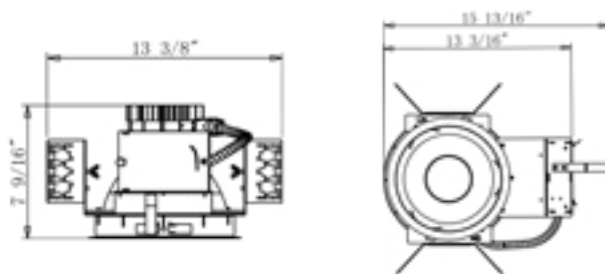

ORDERING GUIDE / YOUR PRODUCT CODE

SERIES	INPUT VOLTAGE	LED AVAILABLE	WATTAGE / LUMEN	CCT	OPTIONS	TRIM	LENS TYPE	Finish
AL8-VA 8" Architectural Downlight	<input type="radio"/> 120V	<input type="radio"/> Cree	<input type="radio"/> 25W / 2000 Lm	<input type="radio"/> 2700K	<input type="radio"/> Emergency Backup	<input type="radio"/> Self Flanged	<input type="radio"/> Clear Tempered	<input type="radio"/> Clear
	<input type="radio"/> 277V	<input type="radio"/> Citizen	<input type="radio"/> 35W / 2800 Lm	<input type="radio"/> 3000K	<input type="radio"/> C-Channel Bar Hanger	<input type="radio"/> Self Flanged White	<input type="radio"/> Sand Blasted	<input type="radio"/> Haze
	<input type="radio"/> 120-277V	<input type="radio"/> Epistar	<input type="radio"/> 40W / 3200 Lm	<input type="radio"/> 3500K	<input type="radio"/> Flat Bar Hanger	<input type="radio"/> NO Flange		<input type="radio"/> White
	DIMMABLE		<input type="radio"/> Seoul		<input type="radio"/> 4000K	<input type="radio"/> Wood Joist Bar Hanger		
	<input type="radio"/> Non-Dimmable	<input type="radio"/> Osram						
	<input type="radio"/> Dimmable							

* Customized Also Available



8" ARCHITECTURAL LED RETROFIT DOWNLIGHT

LIGHT SOURCE
COB LED **BL8-001-R**



DESCRIPTION

Lighting is smooth and comfortable while using 50% less energy than the common CFL downlight. Eco-friendly no lead or mercury. Designed to install into an existing downlights mounting frame and convert them into energy efficient LED downlights to save anywhere from 35% up to 75% on energy cost. Ideal suited for use in commercial, retail and other architectural applications. Available with dedicated Emergency Battery Back-up.

ELECTRICAL SYSTEM

Thermal protection guard protects the LED module from overheating and will dim LED module if necessary.

CLEARANCE

Frames require a minimum clearance of 3" ring from thermal insulation and 1/2" from adjacent building component.

JUNCTION BOX

Plaster frame integrated 29 cubic inch 0.064" thick galvanized steel. Provided with four 1/2" knockouts, one 3/4" knockout and four Romex knockouts with true pryout slots and strain clamps. Designed for straight through conduit runs. Electrical connections are made through a single junction box door. Green wire provided for installation with ground wire fed through PVC pipe conduit.

MOUNTING

Designed to install into an existing downlights mounting frame and convert them into energy efficient LED downlights. Flex is designed to attach into existing junction box. Vertically adjustable universal mounting brackets accept flat bar hangers, conduit or C channel. The reflector assembly is held in with 4 "butter-fly" spring clips. Reflector assy quickly attaches with lockable quick connect Hanger bars ordered separately. Compatible with C-channel, flat bar wood joist bar hanger and EMT.

LISTING / WARRANTY

ETL listed to US and Canadian standards for damp location W/Feed through. 5 Years Limited Warranty.



DIMENSIONS

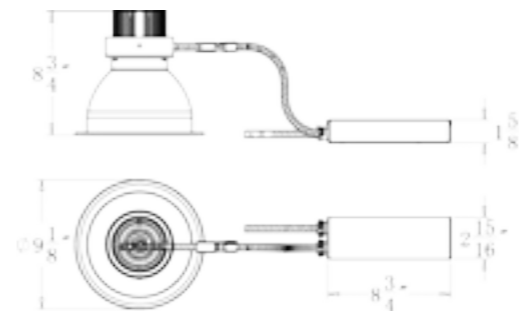

ORDERING GUIDE / YOUR PRODUCT CODE

SERIES	INPUT VOLTAGE	DIMMABLE	LED AVAILABLE	WATTAGE / LUMEN	CCT	TRIM	LENS TYPE	Finish
BL8-001-R 8" ARCHITECTURAL RETROFIT DOWNLIGHT	<input type="radio"/> 120V	<input type="radio"/> Non-Dimmable	<input type="radio"/> Cree	<input type="radio"/> 25W / 2000 Lm	<input type="radio"/> 2700K	<input type="radio"/> Self Flanged	<input type="radio"/> Clear Tempered	<input type="radio"/> Clear
	<input type="radio"/> 277V	<input type="radio"/> Dimmable	<input type="radio"/> Citizen	<input type="radio"/> 35W / 2800 Lm	<input type="radio"/> 3000K	<input type="radio"/> Self Flanged White	<input type="radio"/> Sand Blasted	<input type="radio"/> Haze
	<input type="radio"/> 120-277V		<input type="radio"/> Epistar	<input type="radio"/> 40W / 3200 Lm	<input type="radio"/> 3500K	<input type="radio"/> NO Flange		<input type="radio"/> White
			<input type="radio"/> Seoul		<input type="radio"/> 4000K			
			<input type="radio"/> Osram					

* Customized Also Available

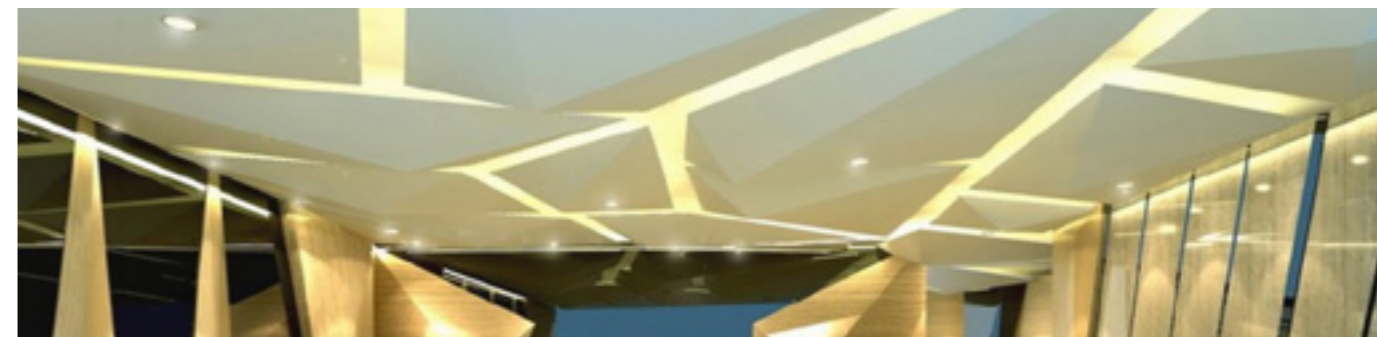

4" HIGH PERFORMANCE REMODEL LED RECESSED DOWNLIGHT SERIES

LIGHT SOURCE
COB LED **BL4-002-B**



new construction also available

DIMMING	80 LED CRI	10 w 12 w 15 w Input Power	800 Lumen 1000 Lumen 1300 Lumen Lumen Output	2700K 3000K 3500K 4000K CCT
---------	----------------------	--	--	---

DESCRIPTION

4 inch Remodel LED recessed fixtures with round apertures offer energy-efficient, precision lighting for accent, task, or wall wash applications. The innovative design allows the LED to be positioned closer to the aperture for maximum light output and efficiency or higher to minimize glare and flash on the trim.

FEATURE

Separable rotating reflector design makes it easy for replacement. High grade diffuser provides uniform light driver can achieve high power factor and conversion efficiency, constant current output. Achieve 3 functions through changing screw setting places and replacing matched reflectors.

REFLECTOR

Input AC 120V/230V/277V at 50/60Hz (90-305V is optional)
PF > 0.98
Dimmable options: NONE/TRIAC
This energy efficient downlight uses 15-watts max. and is comparable to a 60-watt Halogen light bulb.
LED mounted to die-cast / extruded aluminum heat sink w/ active cooling
50,000 hours average rated life at 70% output

LISTING / WARRANTY

ETL listed to US and Canadian standards for damp location W/Feed through.
5 Years Limited Warranty.



DIMENSIONS



Vertical

Adjustable

Wall Wash

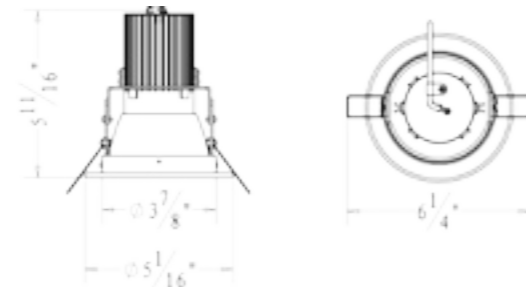

ORDERING GUIDE / YOUR PRODUCT CODE

SERIES	FUNCTIONS	VOLTAGE	DIMMABLE	WATTAGE / LUMEN OUTPUT	CCT	FINISH
○ BL4-002-B 4" Recessed Downlight	○ Vertical Downlight	○ 120V	○ Non-Dimmable	○ LED 10W/800 Lumen	○ 2700K	○ White
	○ Adjustable Downlight	○ 277V	○ 0-10V Dimmable	○ LED 12W/1000 Lumen	○ 3000K	○ Clear
	○ Wall Wash Downlight	○ 120-277V	○ TRIAC Dimmable	○ LED 15W/1300 Lumen	○ 3500K	○ Haze
		○ 347V			○ 4000K	

* Customized Also Available



UNIVERSAL 6" LED RETROFIT DOWNLIGHT

LIGHT SOURCE
COB LED **BL6-002-R**



WITHOUT HOUSING

DIMMING	80 LED CRI	12/15/20 25/30 w Input Power	1000 Lumen 1300 Lumen 1600 Lumen 1900 Lumen 2200 Lumen Lumen Output	2700K 3000K 3500K 4000K CCT
---------	----------------------	--	---	---

UNIVERSAL RETROFIT AND DOWNLIGHT



Retrofit with housing

BL6-002-R-H

Architectural downlight

AL6-VA2-H

Commercial downlight

AL6-VC2-H

DIMENSIONS

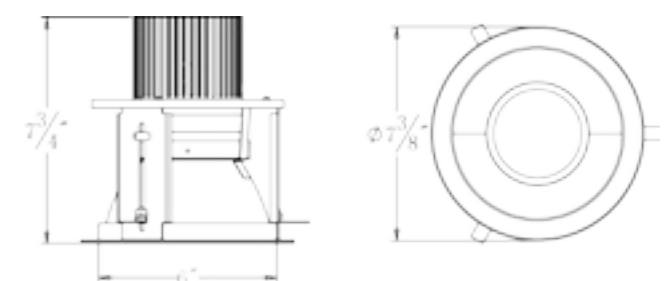

DESCRIPTION

6" LED Downlight Retrofit is available in 1000 to 2200 lumens, with input wattages ranging from 12 to 30W. With an expected service life of 50,000 hours. It helps reduce operating cost by providing over 10 years of maintenance free operation, eliminating the need for lamp inventory and incorrect lamp/color temperature installation. A Chicago Plenum option is also available. Residential & Commercial & Architectural are all available

FEATURE

One fixture converts nearly any manufacturers incandescent, CFL or HID fixtures with a rough-in inner diameter of 6" to 6-5/8" diameter to high efficiency LED. All installation can be performed from below the ceiling without removing existing fixture. Energy savings up to 50-60% vs. CFL and HID. Complete fixture with existing frame and LED retrofit.

REFLECTOR

Reflector is designed to gather the light scattered by the led chip and shape it into functional beams that minimize brightness and glare while eliminating lamp shadow. Reflector is high quality available in clear, semi diffuse or white finish. Self flange trim is standard.

LISTING / WARRANTY

ETL listed to US and Canadian standards for damp location W/Feed through.
5 Years Limited Warranty.



ORDERING GUIDE / YOUR PRODUCT CODE

SERIES	Option	VOLTAGE	DIMMABLE	WATTAGE/LUMEN	CCT	TRIM	REFLECTOR	LENS TYPE
○ BL6-002-R 6" LED Retrofit Downlight	○ Without Housing	○ 120V	○ Non-Dimmable	○ 12W/1000Lumen	○ 2700K	○ Self Flanged	○ Clear	○ Clear
		○ 277V	○ 0-10V Dimmable	○ 15W/1300Lumen	○ 3000K	○ Self Flanged White	○ Haze	○ Tempered
○ AL6-VA2 6" Architectural LED Downlight	○ With Housing	○ 120-277V	○ TRIAC Dimmable	○ 20W/1600Lumen	○ 3500K	○ No Flange	○ White	○ Sand Blasted
		○ 347V		○ 25W/1900Lumen	○ 4000K			
○ AL6-VC2 6" Commercial LED Downlight				○ 30W/2200Lumen				

* Customized Also Available

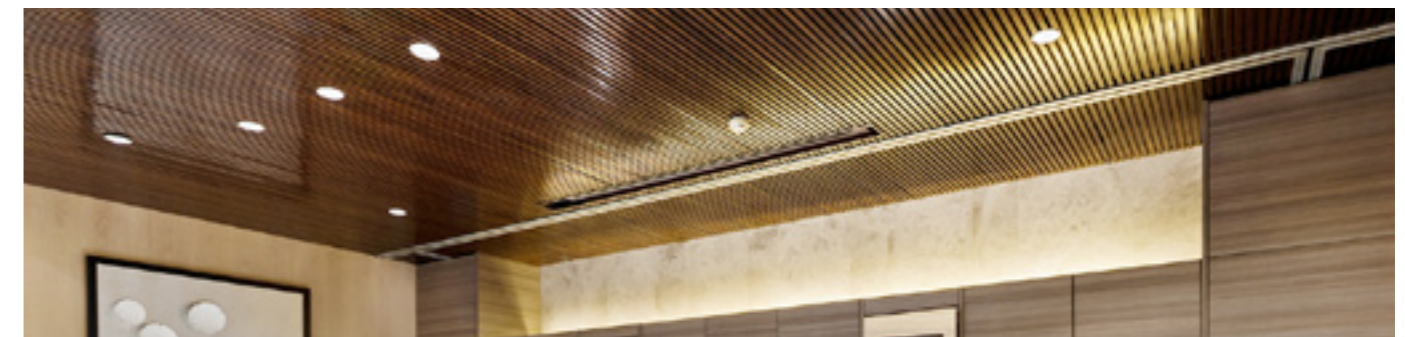

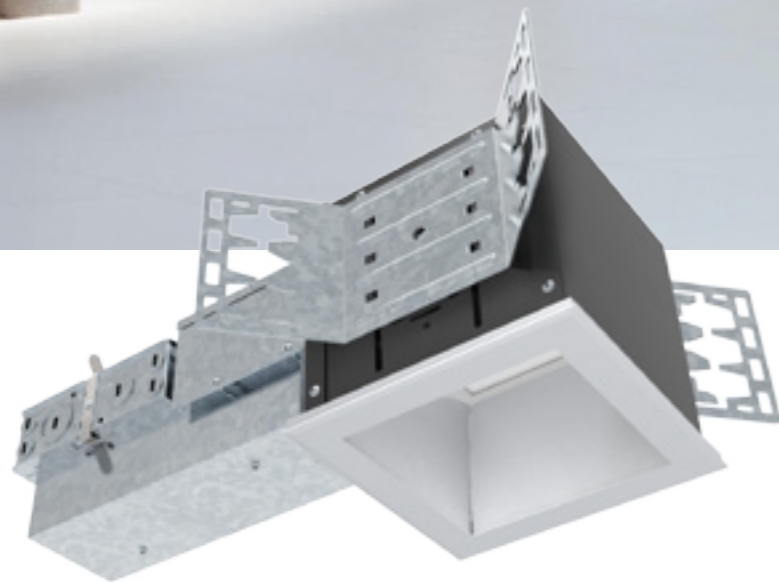

4" | 6"

ARCHITECTURAL SQUARE LED RECESSED DOWNLIGHT

Liteharbor Architectural LED Recessed Downlight applying latest technology achieves powerful lighting performance with high lumen efficiency. This LED solution provides a clean aesthetic look and ideal for architectural lighting applications.

4" ARCHITECTURAL SQUARE LED RECESSED DOWNLIGHT

LIGHT SOURCE SMD CHIPS **AL4-FS**



DESCRIPTION

Architectural LED luminaire, iron shell spray production, with anti-corrosion shell. Emergency system is available. Isolated power supply, safe and without flicker. LED light source using high quality, high lumen and high CRI LED bead. Square emitting surface, with uniform light distribution, high luminous efficiency. Energy saving, long lifespan even without maintain.

LAMPSHADE

Aluminum fog reflective reflector, high light uniformity. With marbles design mode, the overall height of the size is controlled, smooth appearance, excellent visual effects.

LIGHT SOURCE \ RADIATOR

High light transmittance, strong light diffusion performance, no shadow no glare. Point light source emitting turned into spherical light emitting. Milky white light transmission rate reach 90% above, Excellent concealed light source, achieve the best light transmission rate without seeing the LED lamp bead. Outstanding heat dissipation aluminum material, the temperature is guaranteed to be the touch temperature below.

LOCATING PART

Locating part, easy for installation, will not cause abnormal phenomena such as deformation. Resolved the problem of product is not centered.

LISTING / WARRANTY

ETL listed to US and Canadian standards for damp location W/Feed through. 5 Years Limited Warranty.



DIMENSIONS

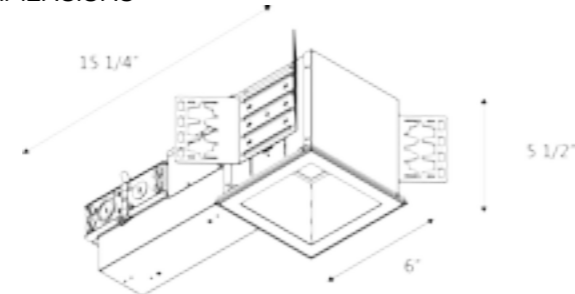

DIMMING	80/90	120V/277V	12W 18W 24W	960Lm 1440Lm 1920Lm	2700K 3000K 3500K 4000K
---------	-------	-----------	-------------------	---------------------------	----------------------------------

Power	12W/18W/24W
Input Voltage	120V/277V/120V-277V
Lumen	960/1440/1920LM
Power Factor	PF>0.98
CRI	80+/90+
Beam Angle	60°, 90° Optional
Dimmable	NONE/0 ~ 10v Dimming
Lifespan	50000Hours

ORDERING GUIDE / YOUR PRODUCT CODE

SERIES	INPUT VOLTAGE	BEAM ANGLE	POWER/LUMEN	CCT	DIMMABLE	FINISH
○ AL4-FS 4" Architectural LED Downlight	○ 120V ○ 277V ○ 120-277V	○ 60° Optional ○ 90° Optional	○ 12W 960LM ○ 18W 1440LM ○ 24W 1920LM	○ 2700K ○ 3000K ○ 3500K ○ 4000K	○ NONE ○ 0 ~ 10v Dimming ○ TRIAC Dimming	○ White ○ Black ○ Satin Nickel ○ Gray

* Customized Also Available

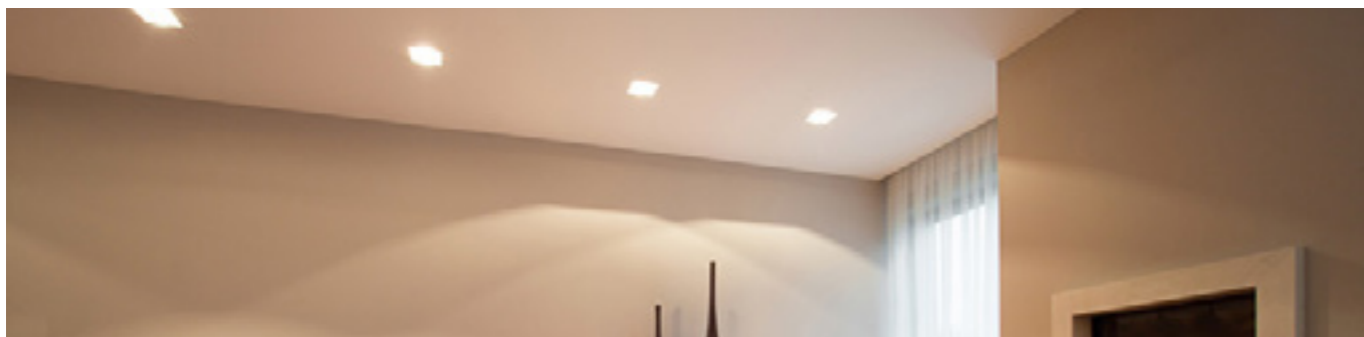

6" ARCHITECTURAL SQUARE LED RECESSED DOWNLIGHT

LIGHT SOURCE SMD CHIPS **AL6-FS**



DESCRIPTION

Architectural LED luminaire, iron shell spray production, with anti-corrosion shell. Emergency system is available. Isolated power supply, safe and without flicker. LED light source using high quality, high lumen and high CRI LED bead. Square emitting surface, with uniform light distribution, high luminous efficiency. Energy saving, long lifespan even without maintain.

LAMPSHADE

Aluminum fog reflective reflector, high light uniformity. With marbles design mode, the overall height of the size is controlled, smooth appearance, excellent visual effects.

LIGHT SOURCE \ RADIATOR

High light transmittance, strong light diffusion performance, no shadow no glare. Point light source emitting turned into spherical light emitting. Milky white light transmission rate reach 90% above, Excellent concealed light source, achieve the best light transmission rate without seeing the LED lamp bead. Outstanding heat dissipation aluminum material, the temperature is guaranteed to be the touch temperature below.

LOCATING PART

Locating part, easy for installation, will not cause abnormal phenomena such as deformation. Resolved the problem of product is not centered.

LISTING / WARRANTY

ETL listed to US and Canadian standards for damp location W/Feed through. 5 Years Limited Warranty.



DIMENSIONS

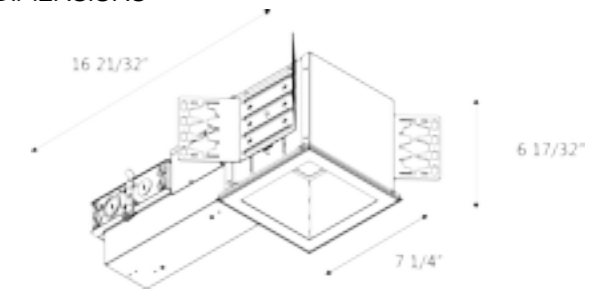

DIMMING	80/90	120V/277V	18W 24W 32W	1440Lm 1920Lm 2560Lm	2700K 3000K 3500K 4000K
---------	-------	-----------	-------------------	----------------------------	----------------------------------

Power	18W/24W/32W
Input Voltage	120V/277V/120V-277V
Lumen	1440/1920/2560LM
Power Factor	PF>0.98
CRI	80+/90+
Beam Angle	60°, 90° Optional
Dimmable	NONE/0 ~ 10v Dimming
Lifespan	50000Hours

ORDERING GUIDE / YOUR PRODUCT CODE

SERIES	INPUT VOLTAGE	BEAM ANGLE	POWER/LUMEN	CCT	DIMMABLE	FINISH
○ AL6-FS 6" Architectural LED Downlight	○ 120V ○ 277V ○ 120-277V	○ 60° Optional ○ 90° Optional	○ 18W 1440LM ○ 24W 1920LM ○ 32W 2560LM	○ 2700K ○ 3000K ○ 3500K ○ 4000K	○ NONE ○ 0 ~ 10v Dimming ○ TRIAC Dimming	○ White ○ Black ○ Satin Nickel ○ Gray

* Customized Also Available





DECORATIVE CYLINDERS PENDANT LED DOWNLIGHT

Liteharbor architectural LED cylinder with specification grade reflector available in 4", 6" and 8" apertures. With a built-in reflector for superior optics and an appealing cylindrical profile and is perfect for the commercial or residential applications.

4 INCH CYLINDERS LED PENDANT DOWNLIGHT

LIGHT SOURCE
COB LED **AL4-VA-FM**



DESCRIPTION

The architectural LED cylinder with specification grade reflector available in 4", 6" and 8" apertures. With a built-in reflector for superior optics and an appealing cylindrical profile and is perfect for the commercial or residential applications.

FEATURES

High performance exterior rated LED downlights. All aluminum construction, powder coat painted in white, black or silver finish for harsh, weatherproof applications. 120V AC Direct technology in 9W, 13W, 17W or 21W dimmable modules with integrated circuit. Easy installation and ultra energy efficient.

MOUNTING

Pendant mounted.

LISTING / WARRANTY

ETL listed to US and Canadian standards for damp location W/Feed through. 5 Years Limited Warranty.



DIMMING	80/90 LED CRI	9/13/17 /21W Wattage	AC 120V ~277V Voltage	90 Lm/W Luminous efficiency	2700K 3000K 3500K 4000K CCT
---------	------------------	-------------------------	--------------------------	-----------------------------------	---

Material	Die cast aluminum
Input Voltage	AC 120V~277V 50/60Hz
Wattage	9/13/17/21W
CCT	2700-4000K
Lumen	810/1170/1530/1890LM
PF	>0.98
CRI	80+/90+
Luminous efficiency	90lm /W
Shape	Cylinders

DIMENSIONS

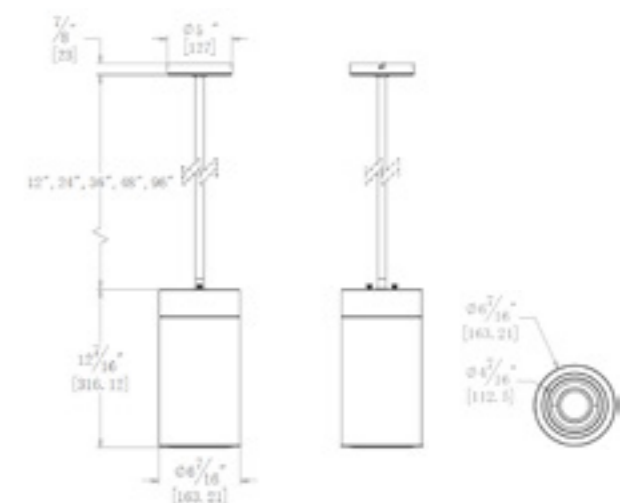

ORDERING GUIDE / YOUR PRODUCT CODE

SERIES	INPUT VOLTAGE	Wattage	CCT	FINISH
○ AL4-VA-FM 4" Cylinder LED Pendant Downlight	○ 120V ○ 277V ○ 120-277V	○ 9W ○ 13W ○ 17W ○ 21W	○ 2700K ○ 3000K ○ 3500K ○ 4000K	○ White ○ Black ○ Red ○ Blue

* Other Special Requirements Please Contact with us.



6 INCH CYLINDERS LED PENDANT DOWNLIGHT

LIGHT SOURCE COB LED **AL6-VA-FM**



DESCRIPTION

The architectural LED cylinder with specification grade reflector available in 4", 6" and 8" apertures. With a built-in reflector for superior optics and an appealing cylindrical profile and is perfect for the commercial or residential applications.

FEATURES

High performance exterior rated LED downlights.
All aluminum construction, powder coat painted in white, black or silver finish for harsh, weatherproof applications.
120V AC Direct technology in 9W, 13W, 17W, 21W or 26W dimmable modules with integrated circuit.
Easy installation and ultra energy efficient.

MOUNTING

Pendant mounted.

LISTING / WARRANTY

ETL listed to US and Canadian standards for damp location W/Feed through.
5 Years Limited Warranty.



DIMENSIONS

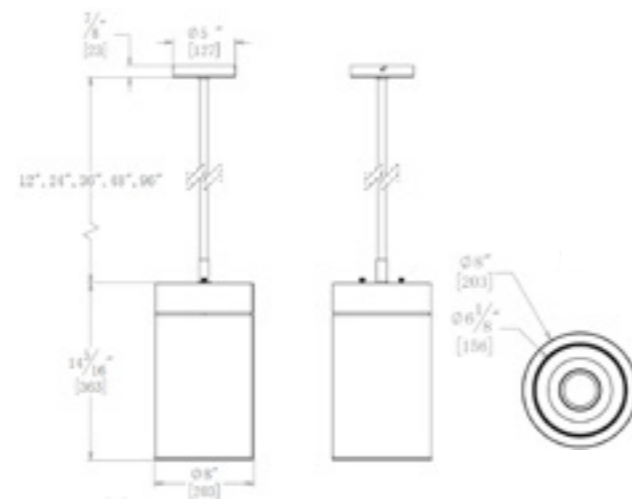

--	--	--	--	--	--

Material	Die cast aluminum
Input Voltage	AC 120V~277V 50/60Hz
Wattage	9/13/17/21/26W
CCT	2700-4000K
Lumen	810/1170/1530/1890/2340LM
PF	>0.98
CRI	80+/90+
Luminous efficiency	90lm /W
Shape	Cylinders

ORDERING GUIDE / YOUR PRODUCT CODE

SERIES	INPUT VOLTAGE	Wattage	CCT	FINISH
○ AL6-VA-FM 6" Cylinder LED Pendant Downlight	○ 120V	○ 9W	○ 2700K	○ White
	○ 277V	○ 13W	○ 3000K	○ Black
	○ 120-277V	○ 17W	○ 3500K	○ Red
		○ 21W	○ 4000K	○ Blue
		○ 26W		

* Other Special Requirements Please Contact with us.



8 INCH CYLINDERS LED PENDANT DOWNLIGHT

LIGHT SOURCE COB LED **AL8-VA-FM**



DESCRIPTION

The architectural LED cylinder with specification grade reflector available in 4", 6" and 8" apertures. With a built-in reflector for superior optics and an appealing cylindrical profile and is perfect for the commercial or residential applications.

FEATURES

High performance exterior rated LED downlights.
All aluminum construction, powder coat painted in white, black or silver finish for harsh, weatherproof applications.
120V AC Direct technology in 9W, 13W, 17W, 21W, 26W or 37W dimmable modules with integrated circuit.
Easy installation and ultra energy efficient.

MOUNTING

Pendant mounted.

LISTING / WARRANTY

ETL listed to US and Canadian standards for damp location W/Feed through.
5 Years Limited Warranty.



DIMENSIONS

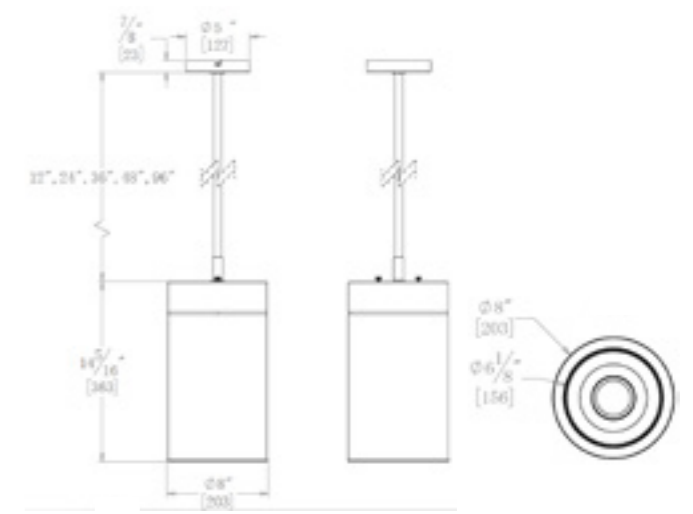

--	--	--	--	--	--

Material	Die cast aluminum
Input Voltage	AC 120V~277V 50/60Hz
Wattage	9/13/17/21/26/37W
CCT	2700-4000K
Lumen	810/1170/1530/1890/2340/3330LM
PF	>0.98
CRI	80+/90+
Luminous efficiency	90lm /W
Shape	Cylinders

ORDERING GUIDE / YOUR PRODUCT CODE

SERIES	INPUT VOLTAGE	Wattage	CCT	FINISH
○ AL8-VA-FM 8" Cylinder LED Pendant Downlight	○ 120V	○ 9W	○ 2700K	○ White
	○ 277V	○ 13W	○ 3000K	○ Black
	○ 120-277V	○ 17W	○ 3500K	○ Red
		○ 21W	○ 4000K	○ Blue
		○ 26W		
		○ 37W		

* Other Special Requirements Please Contact with us.



3.5 INCH CYLINDERS LED PENDANT DOWNLIGHT

LIGHT SOURCE COB LED **AL35-VA-FM**



FEATURES

Sleek, high performance pendant complements pendant downlighting family. Unique flush, surface, cable, pendant mount design allows for precise alignment and adjustment.
All aluminum construction, powder coat painted in white, black or silver finish for harsh, weatherproof applications.
120V AC Direct technology in 10W, 16W or 20W dimmable modules with integrated circuit.
Easy installation and ultra energy efficient.
Dedicated 9° optic with field changeable 12°, 24°, 36° & 50° optics.

MOUNTING

Pendant mounted.

LISTING / WARRANTY

ETL listed to US and Canadian standards for damp location W/Feed through.
5 Years Limited Warranty.



				>0.98 PF icon"/>	
--	--	--	--	------------------	--

Material	Die cast aluminum
Input Voltage	120/277v 50/60Hz input
Wattage	10/16/20W
CCT	2700,3000K,3500K,4000K
PF	>0.98
CRI	80+/90+
Shape	Cylinders

DIMENSIONS

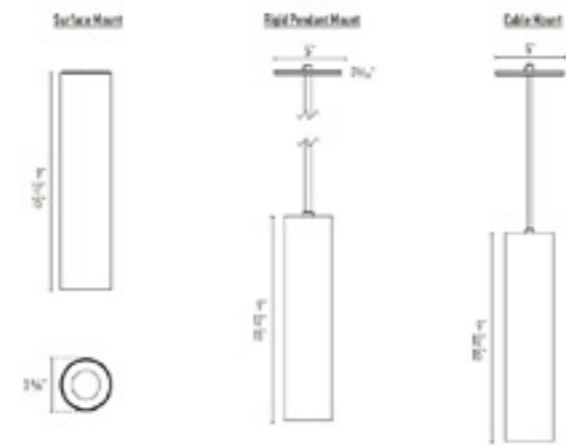

ORDERING GUIDE / YOUR PRODUCT CODE

SERIES	INPUT VOLTAGE	Wattage	FINISH	OPTIC	MOUNTING	CCT	CRI
○ AL35-VA-FM 3.5" Cylinder LED Pendant Downlight	○ 120V	○ 10W	○ White	○ 9° Narrow Spot	○ 48" Cable	○ 2700K	○ 80+
	○ 277V	○ 16W	○ Black	○ 12° Spot	○ 96" Cable	○ 3000K	○ 90+
	○ 120-277V	○ 20W		○ 24° Narrow Flood	○ 12" Rigid Pendant	○ 3500K	
				○ 36° Flood	○ 18" Rigid Pendant	○ 4000K	
			○ 50° Wide Flood	○ 24" Rigid Pendant			
					○ 36" Rigid Pendant		
					○ 48" Rigid Pendant		
					○ Surface Mounted		

* Other Special Requirements Please Contact with us.

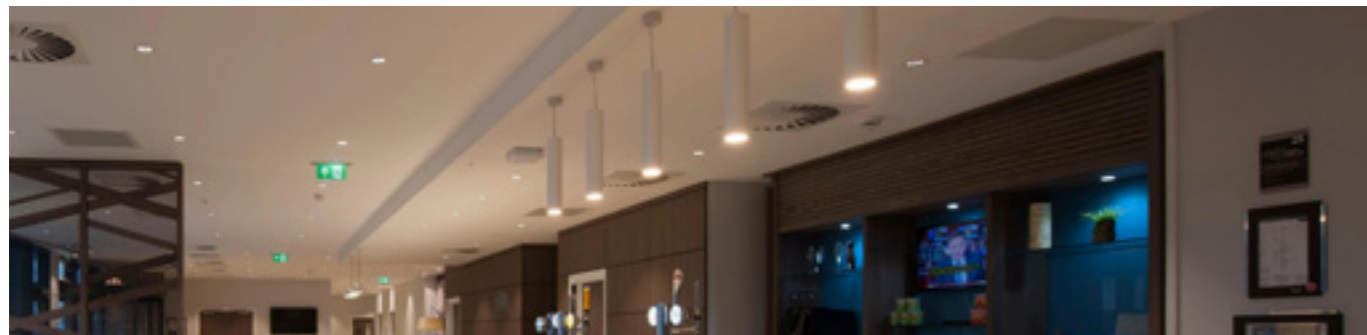

3.5 INCH SQUARE SHAPE LED PENDANT DOWNLIGHT

LIGHT SOURCE COB LED **AL35-VA-SFM**

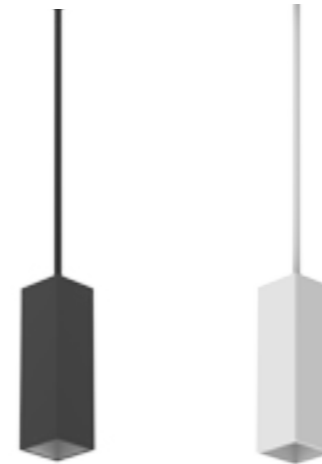

FEATURES

Sleek, high performance pendant complements pendant downlighting family. Unique flush, surface, cable, pendant mount design allows for precise alignment and adjustment.
All aluminum construction, powder coat painted in white, black or silver finish for harsh, weatherproof applications.
120V AC Direct technology in 10W, 16W or 20W dimmable modules with integrated circuit.
Easy installation and ultra energy efficient.
Dedicated 9° optic with field changeable 12°, 24°, 36° & 50° optics.

MOUNTING

Pendant mounted.

LISTING / WARRANTY

ETL listed to US and Canadian standards for damp location W/Feed through.
5 Years Limited Warranty.



				>0.98 PF icon"/>	
--	--	--	--	------------------	--

Material	Die cast aluminum
Input Voltage	120~277v 50/60Hz input
Wattage	10/16/20W
CCT	2700,3000K,3500K,4000K
PF	>0.98
CRI	80+/90+
Shape	Cylinders

DIMENSIONS

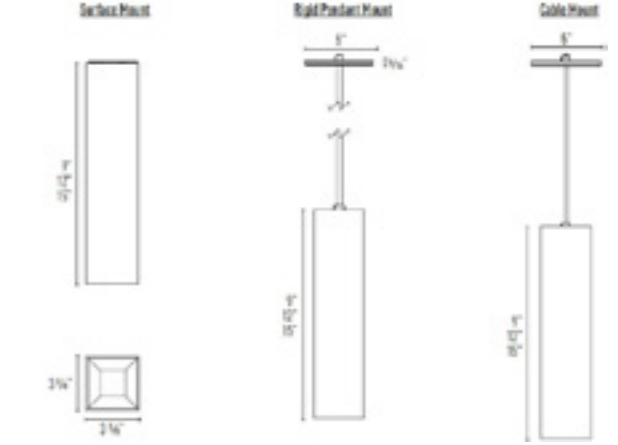

ORDERING GUIDE / YOUR PRODUCT CODE

SERIES	INPUT VOLTAGE	Wattage	FINISH	OPTIC	MOUNTING	CCT	CRI
○ AL35-VA-SFM 3.5" Square LED Pendant Downlight	○ 120V	○ 10W	○ White	○ 9° Narrow Spot	○ 48" Cable	○ 2700K	○ 80+
	○ 277V	○ 16W	○ Black	○ 12° Spot	○ 96" Cable	○ 3000K	○ 90+
	○ 120-277V	○ 20W		○ 24° Narrow Flood	○ 12" Rigid Pendant	○ 3500K	
				○ 36° Flood	○ 18" Rigid Pendant	○ 4000K	
			○ 50° Wide Flood	○ 24" Rigid Pendant			
					○ 36" Rigid Pendant		
					○ 48" Rigid Pendant		
					○ Surface Mounted		

* Other Special Requirements Please Contact with us.



UNIQUE DESIGN SURFACE MOUNTED LED DOWNLIGHT

Liteharbor Lighting Surface Mounted LED Downlight incorporates modern aesthetics, and the beam angle can be pointed in any direction to meet your different lighting needs. The patented convenient installation structure for quick and easy installation.



HIGH PERFORMANCE MULTILAMPS SURFACE MOUNTED LED DOWNLIGHT

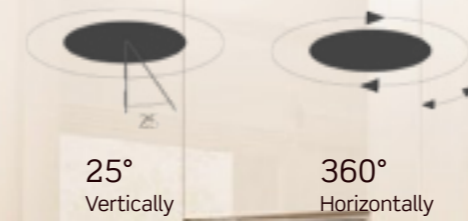

Lamp Body: Made of die-cast aluminum, the material is light and has good heat dissipation.
 Power Supply: Constant current power supply, long life, low electromagnetic interference, low energy consumption, high performance, short circuit and over current protection.
 Light Source: Using big brand COB lamp beads, color rendering index 80+, 90+ are optional, a variety of color temperature options (3000K, 4000K, 5000K, 6500K).
 Mounting plate: Patent structure.

STANDARD CONFIGURATIONS

Square Shape:



Round Shape:



WHY IS THE SURFACE MOUNTED LED DOWNLIGHT SO POPULAR?

- Adjustable design to create more illuminating effect
- Adaptable 3" and 4" embedded box mounting
- Unique design, better to decorate your home
- 1/2/3/4 lamps providing more options for you
- Patented convenient installation structure for quick and easy installation



All Liteharbor downlights are offered with 5-Year limited warranty. A robust sleek design, state-of-the-art engineering and a rigorous testing regimen are all factors that make our products so reliable. All the recessed multiples are cETLus listed. They can be well sold in North America market.

INSTALLATION INSTRUCTION



STEP 1.
Remove the installation bracket from the back of the fixture.

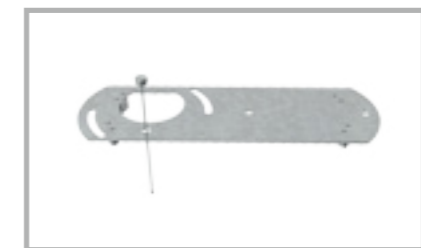

STEP 2.
Pass the safety rope through the mounting plate.

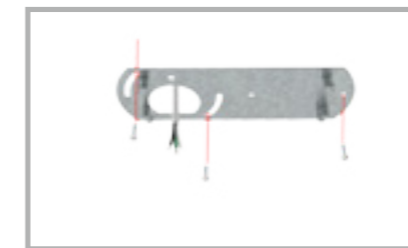

STEP 3.
Attach the bracket to Junction box using the 2 screws(provided)-pull the AC cable through the bracket center hole. And fix the other end to the ceiling with self-tapping screws.

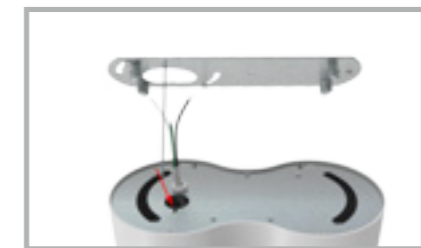

STEP 4.
Install the Safety Installation Cable from light fixture by pushing into the "key hole" in bracket.

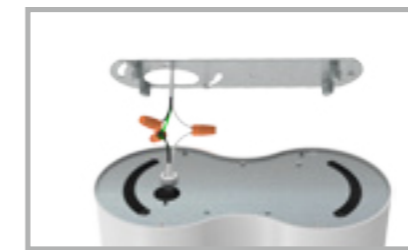

STEP 5.
Make the wire connections.



STEP 6.
Push and feed all wires up into Junction box as you raise the fixture up into place.



STEP 7.
Align slots on the edge of fixture with the ball bearings on the mounting bracket and PUSH to lock fixture in place.

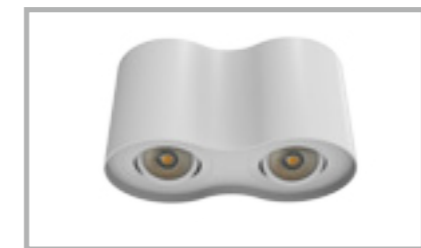

STEP 8.
Installed-Congratulations... Enjoy the light!

SURFACE MOUNTED ROUND SHAPE LED DOWNLIGHT WITH 1 LAMP

LIGHT SOURCE
COB LED **DL4011**



FEATURES

This is a circular surface-mounted spotlight that incorporates modern aesthetics. It has a beautifully curved shape, scientific light distribution, good light output, uniform light output, high efficiency and energy saving.
The light source can be adjusted 25° vertically and 360° horizontally to direct the beam in any direction to meet your diverse lighting needs.
The beam angle can be 12°, 24°, and suitable lamps can be selected according to actual needs to provide professional lighting.
Patented convenient installation structure for quick and easy installation.
Dimming: Non-Dimming/TRIAC Dimming.
Adaptable 3" and 4" embedded box mounting.

SPECIFICATIONS

Lamp Body: Made of die-cast aluminum, the material is light and has good heat dissipation.
Power Supply: Constant current power supply, long life, low electromagnetic interference, low energy consumption, high performance, short circuit and overcurrent protection.
Light Source: Using big brand COB lamp beads, color rendering index 80+, 90+ are optional, a variety of color temperature options (3000K, 4000K, 5000K, 6500K).
Mounting plate: Patent structure.

APPLICATIONS

Apply to automotive and parking, education, government, healthcare, hospitality, offices and banks, religious, retail.

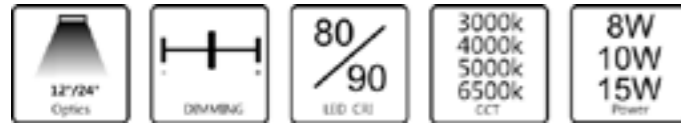

DIMENSIONS

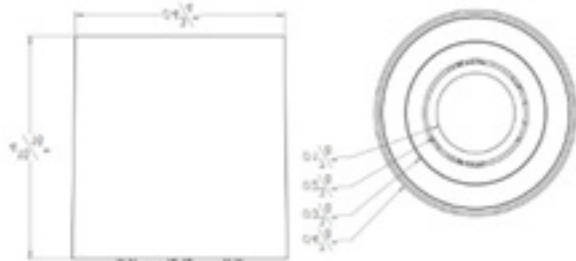

LISTING / WARRANTY

ETL listed to US and Canadian standards for damp location W/Feed through.
5 Years Limited Warranty.



ORDERING GUIDE / YOUR PRODUCT CODE

SERIES	LUMEN	VOLTAGE	CCT	CRI	DIMMABLE	FINISH
DL4011	560lm	AC 120V	2700K	80+	NON-Dimmable	Black
1 Lamp Surface Mounted LED Downlight	800lm	AC 230V	3000K	90+	TRIAC Dimming	White
	1250lm	AC 277V	4000K			
		AC120-277V	5000K			
			6500K			

* Customized Also Available

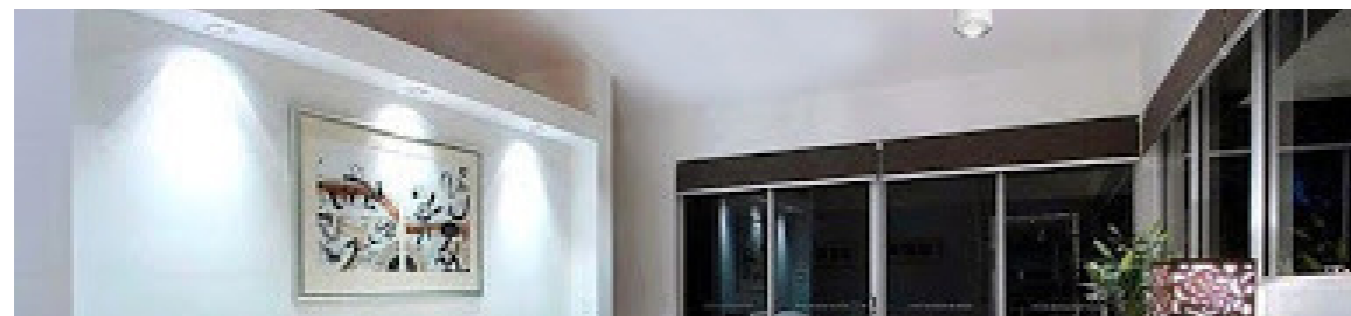

SURFACE MOUNTED ROUND SHAPE LED DOWNLIGHT WITH 2 LAMPS

LIGHT SOURCE
COB LED **DL4012**



FEATURES

This is a circular surface-mounted spotlight that incorporates modern aesthetics. It has a beautifully curved shape, scientific light distribution, good light output, uniform light output, high efficiency and energy saving.
The light source can be adjusted 25° vertically and 360° horizontally to direct the beam in any direction to meet your diverse lighting needs.
The beam angle can be 12°, 24°, and suitable lamps can be selected according to actual needs to provide professional lighting.
Patented convenient installation structure for quick and easy installation.
Dimming: Non-Dimming/TRIAC Dimming.
Adaptable 3" and 4" embedded box mounting.

SPECIFICATIONS

Lamp Body: Made of die-cast aluminum, the material is light and has good heat dissipation.
Power Supply: Constant current power supply, long life, low electromagnetic interference, low energy consumption, high performance, short circuit and overcurrent protection.
Light Source: Using big brand COB lamp beads, color rendering index 80+, 90+ are optional, a variety of color temperature options (3000K, 4000K, 5000K, 6500K).
Mounting plate: Patent structure.

APPLICATIONS

Apply to automotive and parking, education, government, healthcare, hospitality, offices and banks, religious, retail.

LISTING / WARRANTY

ETL listed to US and Canadian standards for damp location W/Feed through.
5 Years Limited Warranty.



DIMENSIONS



ORDERING GUIDE / YOUR PRODUCT CODE

SERIES	LUMEN	VOLTAGE	CCT	CRI	DIMMABLE	FINISH
DL4012	1120lm	AC 120V	2700K	80+	NON-Dimmable	Black
2 Lamps Surface Mounted LED Downlight	1600lm	AC 230V	3000K	90+	TRIAC Dimming	White
	2500lm	AC 277V	4000K			
		AC120-277V	5000K			
			6500K			

* Customized Also Available

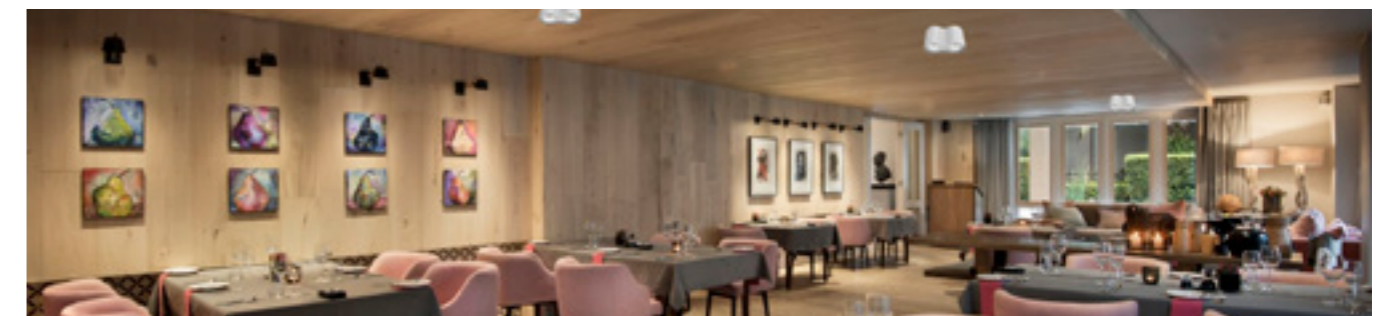

SURFACE MOUNTED ROUND SHAPE LED DOWNLIGHT WITH 3 LAMPS

LIGHT SOURCE
COB LED **DL4013**

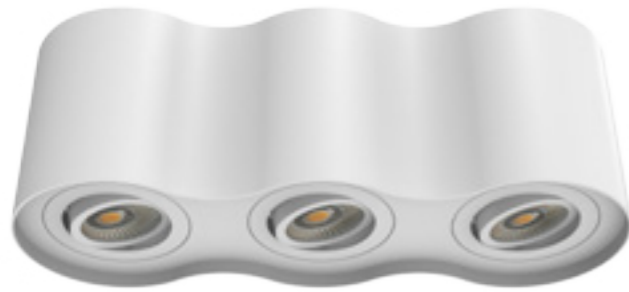

FEATURES

This is a circular surface-mounted spotlight that incorporates modern aesthetics. It has a beautifully curved shape, scientific light distribution, good light output, uniform light output, high efficiency and energy saving.
The light source can be adjusted 25° vertically and 360° horizontally to direct the beam in any direction to meet your diverse lighting needs.
The beam angle can be 12°, 24°, and suitable lamps can be selected according to actual needs to provide professional lighting.
Patented convenient installation structure for quick and easy installation.
Dimming: Non-Dimming/TRIAC Dimming.
Adaptable 3" and 4" embedded box mounting.

SPECIFICATIONS

Lamp Body: Made of die-cast aluminum, the material is light and has good heat dissipation.
Power Supply: Constant current power supply, long life, low electromagnetic interference, low energy consumption, high performance, short circuit and overcurrent protection.
Light Source: Using big brand COB lamp beads, color rendering index 80+, 90+ are optional, a variety of color temperature options (3000K, 4000K, 5000K, 6500K).
Mounting plate: Patent structure.

APPLICATIONS

Apply to automotive and parking, education, government, healthcare, hospitality, offices and banks, religious, retail.

LISTING / WARRANTY

ETL listed to US and Canadian standards for damp location W/Feed through.
5 Years Limited Warranty.

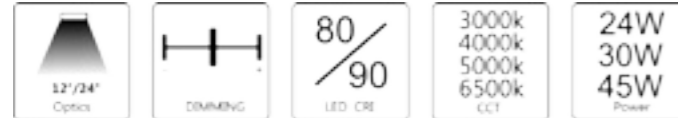

DIMENSIONS

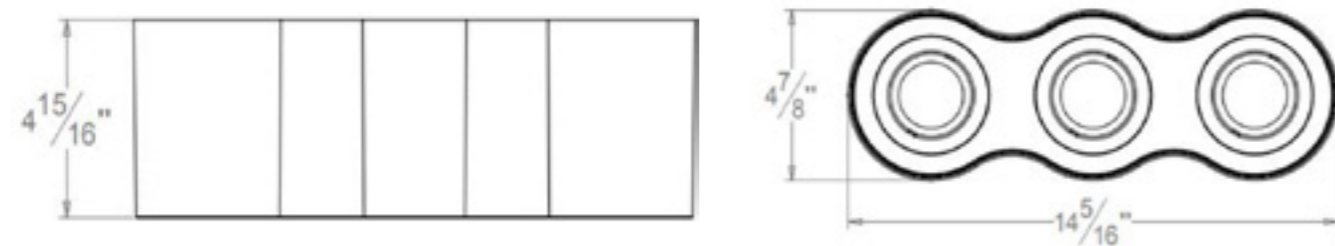

ORDERING GUIDE / YOUR PRODUCT CODE

SERIES	LUMEN	VOLTAGE	CCT	CRI	DIMMABLE	FINISH
DL4013	1680lm	AC 120V	2700K	80+	NON-Dimmable	Black
3 Lamps Surface Mounted LED Downlight	2400lm	AC 230V	3000K	90+	TRIAC Dimming	White
	3750lm	AC 277V	4000K			
		AC120-277V	5000K			
			6500K			

* Customized Also Available



SURFACE MOUNTED ROUND SHAPE LED DOWNLIGHT WITH 3 LAMPS

LIGHT SOURCE
COB LED **DL4013A**



FEATURES

This is a circular surface-mounted spotlight that incorporates modern aesthetics. It has a beautifully curved shape, scientific light distribution, good light output, uniform light output, high efficiency and energy saving.
The light source can be adjusted 25° vertically and 360° horizontally to direct the beam in any direction to meet your diverse lighting needs.
The beam angle can be 12°, 24°, and suitable lamps can be selected according to actual needs to provide professional lighting.
Patented convenient installation structure for quick and easy installation.
Dimming: Non-Dimming/TRIAC Dimming.
Adaptable 3" and 4" embedded box mounting.

SPECIFICATIONS

Lamp Body: Made of die-cast aluminum, the material is light and has good heat dissipation.
Power Supply: Constant current power supply, long life, low electromagnetic interference, low energy consumption, high performance, short circuit and overcurrent protection.
Light Source: Using big brand COB lamp beads, color rendering index 80+, 90+ are optional, a variety of color temperature options (3000K, 4000K, 5000K, 6500K).
Mounting plate: Patent structure.

APPLICATIONS

Apply to automotive and parking, education, government, healthcare, hospitality, offices and banks, religious, retail.

LISTING / WARRANTY

ETL listed to US and Canadian standards for damp location W/Feed through.
5 Years Limited Warranty.

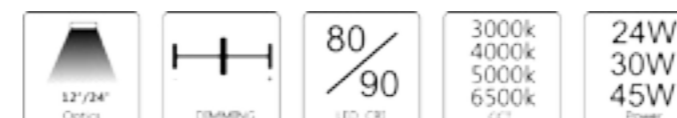

DIMENSIONS

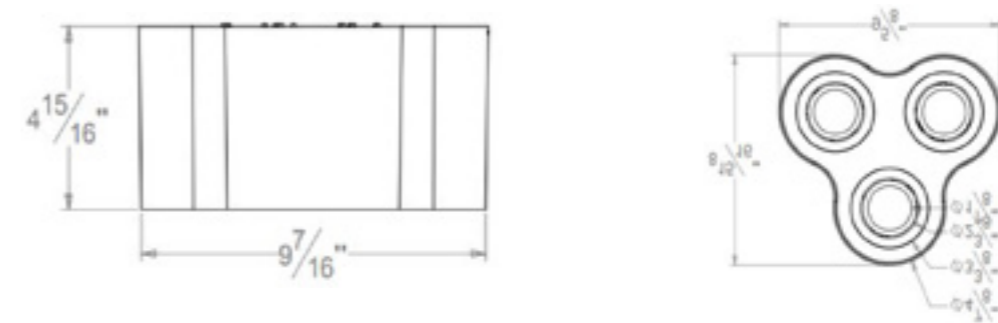

ORDERING GUIDE / YOUR PRODUCT CODE

SERIES	LUMEN	VOLTAGE	CCT	CRI	DIMMABLE	FINISH
DL4013A	1680lm	AC 120V	2700K	80+	NON-Dimmable	Black
3 Lamps Surface Mounted LED Downlight	2400lm	AC 230V	3000K	90+	TRIAC Dimming	White
	3750lm	AC 277V	4000K			
		AC120-277V	5000K			
			6500K			

* Customized Also Available

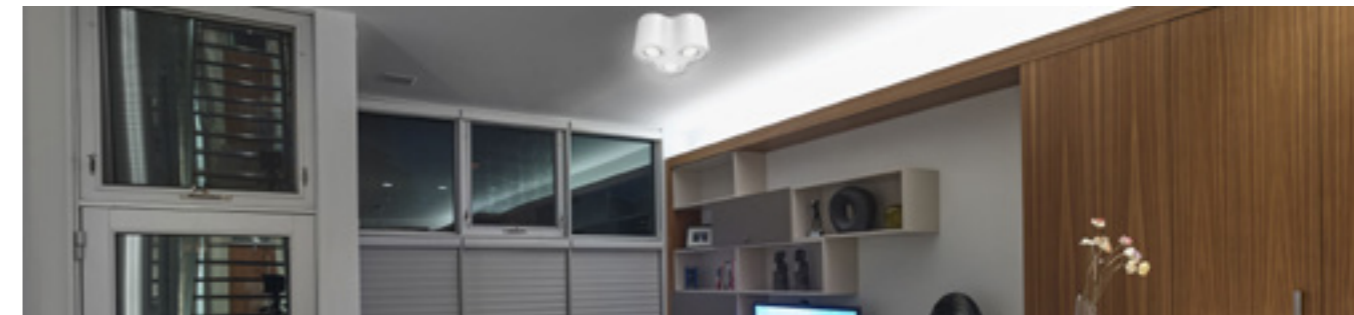

SURFACE MOUNTED ROUND SHAPE LED DOWNLIGHT WITH 4 LAMPS

LIGHT SOURCE
COB LED **DL4014**

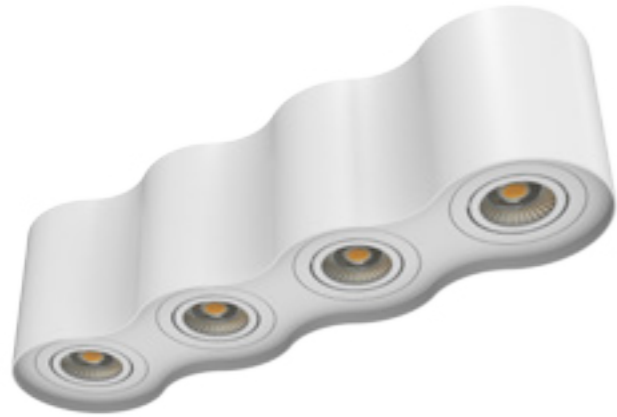

FEATURES

This is a circular surface-mounted spotlight that incorporates modern aesthetics. It has a beautifully curved shape, scientific light distribution, good light output, uniform light output, high efficiency and energy saving. The light source can be adjusted 25° vertically and 360° horizontally to direct the beam in any direction to meet your diverse lighting needs. The beam angle can be 12°, 24°, and suitable lamps can be selected according to actual needs to provide professional lighting. Patented convenient installation structure for quick and easy installation. Dimming: Non-Dimming/TRIAC Dimming. Adaptable 3" and 4" embedded box mounting.

SPECIFICATIONS

Lamp Body: Made of die-cast aluminum, the material is light and has good heat dissipation.
Lamp Body: Made of die-cast aluminum, the material is light and has good heat dissipation.
Power Supply: Constant current power supply, long life, low electromagnetic interference, low energy consumption, high performance, short circuit and overcurrent protection.
Light Source: Using big brand COB lamp beads, color rendering index 80+, 90+ are optional, a variety of color temperature options (3000K, 4000K, 5000K, 6500K).
Mounting plate: Patent structure.

APPLICATIONS

Apply to automotive and parking, education, government, healthcare, hospitality, offices and banks, religious, retail.

LISTING / WARRANTY

ETL listed to US and Canadian standards for damp location W/Feed through. 5 Years Limited Warranty.



DIMENSIONS

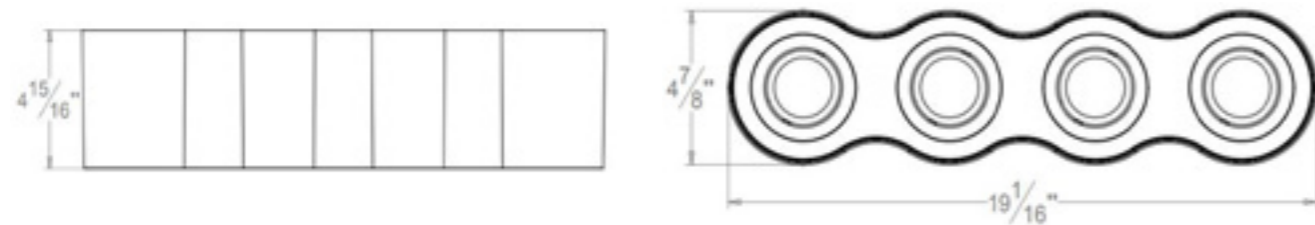

ORDERING GUIDE / YOUR PRODUCT CODE

SERIES	LUMEN	VOLTAGE	CCT	CRI	DIMMABLE	FINISH
DL4014	2240lm	AC 120V	2700K	80+	NON-Dimmable	Black
4 Lamps Surface Mounted LED Downlight	3200lm	AC 230V	3000K	90+	TRIAC Dimming	White
	5000lm	AC 277V	4000K			
		AC120-277V	5000K			
			6500K			

* Customized Also Available



SURFACE MOUNTED ROUND SHAPE LED DOWNLIGHT WITH 4 LAMPS

LIGHT SOURCE
COB LED **DL4022A**



FEATURES

This is a circular surface-mounted spotlight that incorporates modern aesthetics. It has a beautifully curved shape, scientific light distribution, good light output, uniform light output, high efficiency and energy saving. The light source can be adjusted 25° vertically and 360° horizontally to direct the beam in any direction to meet your diverse lighting needs. The beam angle can be 12°, 24°, and suitable lamps can be selected according to actual needs to provide professional lighting. Patented convenient installation structure for quick and easy installation. Dimming: Non-Dimming/TRIAC Dimming. Adaptable 3" and 4" embedded box mounting.

SPECIFICATIONS

Lamp Body: Made of die-cast aluminum, the material is light and has good heat dissipation.
Power Supply: Constant current power supply, long life, low electromagnetic interference, low energy consumption, high performance, short circuit and overcurrent protection.
Light Source: Using big brand COB lamp beads, color rendering index 80+, 90+ are optional, a variety of color temperature options (3000K, 4000K, 5000K, 6500K).
Mounting plate: Patent structure.

APPLICATIONS

Apply to automotive and parking, education, government, healthcare, hospitality, offices and banks, religious, retail.

LISTING / WARRANTY

ETL listed to US and Canadian standards for damp location W/Feed through. 5 Years Limited Warranty.



DIMENSIONS

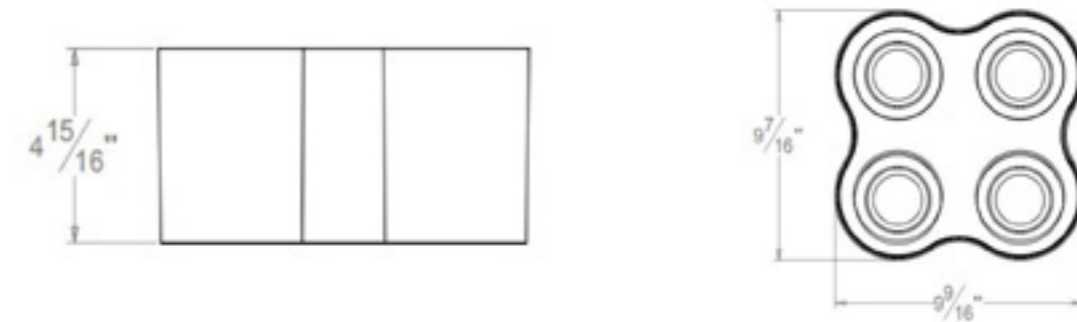

ORDERING GUIDE / YOUR PRODUCT CODE

SERIES	LUMEN	VOLTAGE	CCT	CRI	DIMMABLE	FINISH
DL4022A	2240lm	AC 120V	2700K	80+	NON-Dimmable	Black
4 Lamps Surface Mounted LED Downlight	3200lm	AC 230V	3000K	90+	TRIAC Dimming	White
	5000lm	AC 277V	4000K			
		AC120-277V	5000K			
			6500K			

* Customized Also Available



SURFACE MOUNTED ROUND SHAPE LED DOWNLIGHT WITH 4 LAMPS

DL4022B

FEATURES

This is a circular surface-mounted spotlight that incorporates modern aesthetics. It has a beautifully curved shape, scientific light distribution, good light output, uniform light output, high efficiency and energy saving.

The light source can be adjusted 25° vertically and 360° horizontally to direct the beam in any direction to meet your diverse lighting needs.

The beam angle can be 12°, 24°, and suitable lamps can be selected according to actual needs to provide professional lighting.

Patented convenient installation structure for quick and easy installation.

Dimming: Non-Dimming/TRIAC Dimming.

Adaptable 3" and 4" embedded box mounting.

SPECIFICATIONS

Lamp Body: Made of die-cast aluminum, the material is light and has good heat dissipation.

Power Supply: Constant current power supply, long life, low electromagnetic interference, low energy consumption, high performance, short circuit and overcurrent protection.

Light Source: Using big brand COB lamp beads, color rendering index 80+, 90+ are optional, a variety of color temperature options (3000K, 4000K, 5000K, 6500K).

Mounting plate: Patent structure.

APPLICATIONS

Apply to automotive and parking, education, government, healthcare, hospitality, offices and banks, religious, retail.

LISTING / WARRANTY

ETL listed to US and Canadian standards for damp location W/Feed through.
5 Years Limited Warranty.

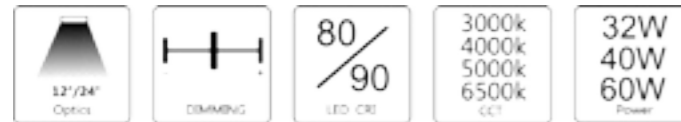

DIMENSIONS

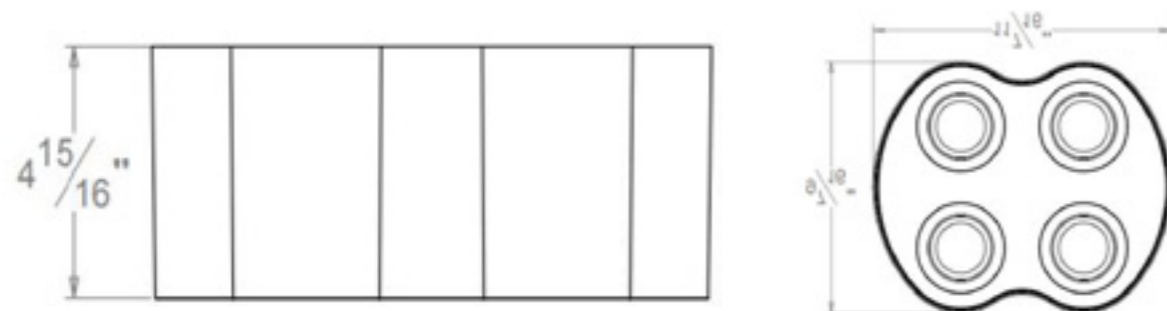

ORDERING GUIDE / YOUR PRODUCT CODE

SERIES	LUMEN	VOLTAGE	CCT	CRI	DIMMABLE	FINISH
○ DL4022B	○ 2240lm	○ AC 120V	○ 2700K	○ 80+	○ NON-Dimmable	○ Black
○ 4 Lamps Surface Mounted LED Downlight	○ 3200lm	○ AC 230V	○ 3000K	○ 90+	○ TRIAC Dimming	○ White
	○ 5000lm	○ AC 277V	○ 4000K			
		○ AC120-277V	○ 5000K			
			○ 6500K			

* Customized Also Available

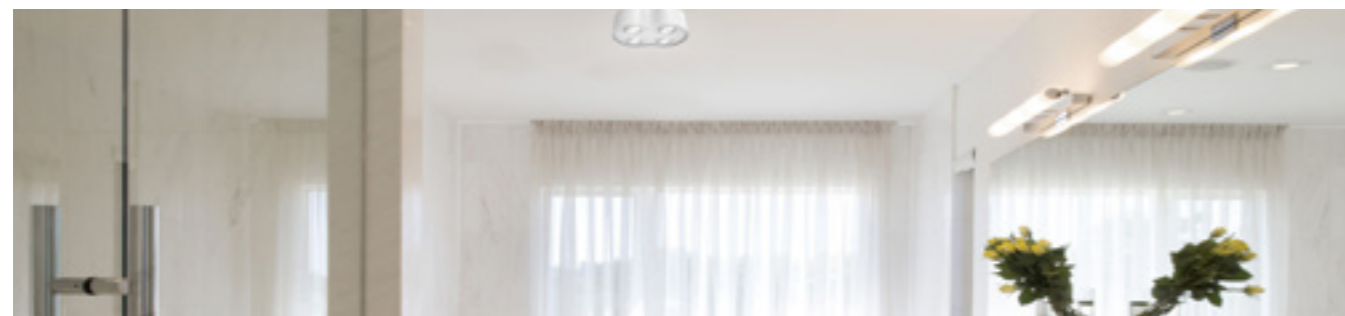

SURFACE MOUNTED SQUARE SHAPE LED DOWNLIGHT WITH 1 LAMP

DL4011-S

FEATURES

This is a square surface-mounted spotlight that incorporates modern aesthetics. It has a beautifully curved shape, scientific light distribution, good light output, uniform light output, high efficiency and energy saving.

The light source can be adjusted 25° vertically and 360° horizontally to direct the beam in any direction to meet your diverse lighting needs.

The beam angle can be 12°, 24°, and suitable lamps can be selected according to actual needs to provide professional lighting.

Patented convenient installation structure for quick and easy installation.

Dimming: Non-Dimming/TRIAC Dimming.

Adaptable 3" and 4" embedded box mounting.

SPECIFICATIONS

Lamp Body: Made of die-cast aluminum, the material is light and has good heat dissipation.

Power Supply: Constant current power supply, long life, low electromagnetic interference, low energy consumption, high performance, short circuit and overcurrent protection.

Light Source: Using big brand COB lamp beads, color rendering index 80+, 90+ are optional, a variety of color temperature options (3000K, 4000K, 5000K, 6500K).

Mounting plate: Patent structure.

APPLICATIONS

Apply to automotive and parking, education, government, healthcare, hospitality, offices and banks, religious, retail.

LISTING / WARRANTY

ETL listed to US and Canadian standards for damp location W/Feed through.
5 Years Limited Warranty.



DIMENSIONS

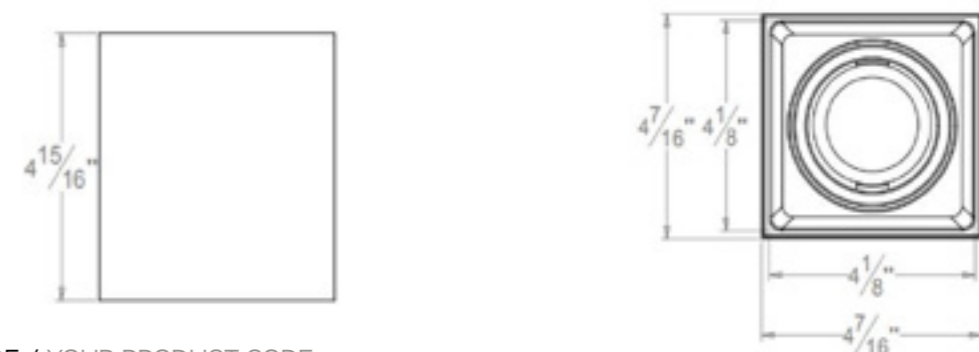

ORDERING GUIDE / YOUR PRODUCT CODE

SERIES	LUMEN	VOLTAGE	CCT	CRI	DIMMABLE	FINISH
○ DL4011-S	○ 560lm	○ AC 120V	○ 2700K	○ 80+	○ NON-Dimmable	○ Black
○ 1 Lamp Surface Mounted LED Downlight	○ 800lm	○ AC 230V	○ 3000K	○ 90+	○ TRIAC Dimming	○ White
	○ 1250lm	○ AC 277V	○ 4000K			
		○ AC120-277V	○ 5000K			
			○ 6500K			

* Customized Also Available

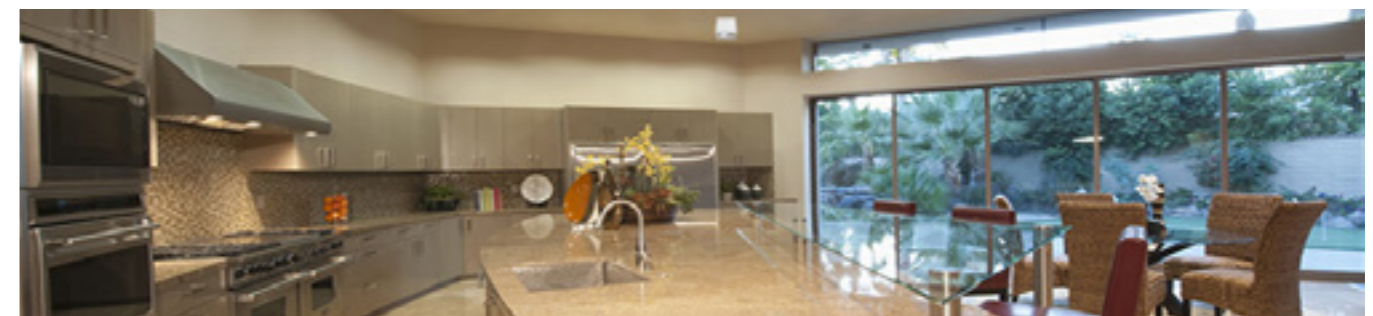

SURFACE MOUNTED SQUARE SHAPE LED DOWNLIGHT WITH 2 LAMPS

DL4012-S
**FEATURES**

This is a square surface-mounted spotlight that incorporates modern aesthetics. It has a beautifully curved shape, scientific light distribution, good light output, uniform light output, high efficiency and energy saving.
The light source can be adjusted 25° vertically and 360° horizontally to direct the beam in any direction to meet your diverse lighting needs.
The beam angle can be 12°, 24°, and suitable lamps can be selected according to actual needs to provide professional lighting.
Patented convenient installation structure for quick and easy installation.
Dimming: Non-Dimming/TRIAC Dimming.
Adaptable 3" and 4" embedded box mounting.

SPECIFICATIONS

Lamp Body: Made of die-cast aluminum, the material is light and has good heat dissipation.
Power Supply: Constant current power supply, long life, low electromagnetic interference, low energy consumption, high performance, short circuit and overcurrent protection.
Light Source: Using big brand COB lamp beads, color rendering index 80+, 90+ are optional, a variety of color temperature options (3000K, 4000K, 5000K, 6500K).
Mounting plate: Patent structure.

APPLICATIONS

Apply to automotive and parking, education, government, healthcare, hospitality, offices and banks, religious, retail.

LISTING / WARRANTY

ETL listed to US and Canadian standards for damp location W/Feed through.
5 Years Limited Warranty.

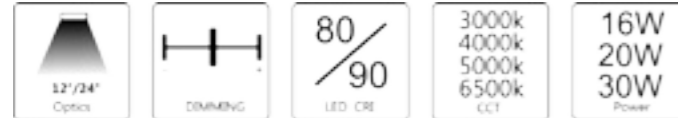
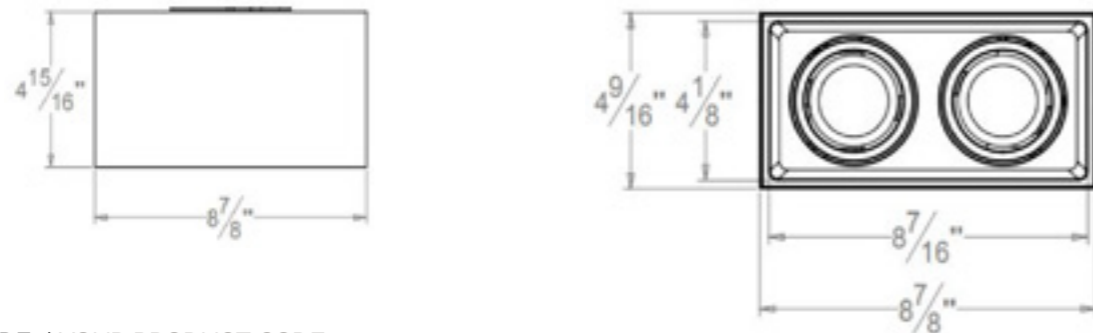
**DIMENSIONS****ORDERING GUIDE / YOUR PRODUCT CODE**

SERIES	LUMEN	VOLTAGE	CCT	CRI	DIMMABLE	FINISH
○ DL4012-S	○ 1120lm	○ AC 120V	○ 2700K	○ 80+	○ NON-Dimmable	○ Black
○ 2 Lamps Surface Mounted LED Downlight	○ 1600lm	○ AC 230V	○ 3000K	○ 90+	○ TRIAC Dimming	○ White
	○ 2500lm	○ AC 277V	○ 4000K			
		○ AC120-277V	○ 5000K			
			○ 6500K			

* Customized Also Available



SURFACE MOUNTED SQUARE SHAPE LED DOWNLIGHT WITH 3 LAMPS

DL4013-S
**FEATURES**

This is a square surface-mounted spotlight that incorporates modern aesthetics. It has a beautifully curved shape, scientific light distribution, good light output, uniform light output, high efficiency and energy saving.
The light source can be adjusted 25° vertically and 360° horizontally to direct the beam in any direction to meet your diverse lighting needs.
The beam angle can be 12°, 24°, and suitable lamps can be selected according to actual needs to provide professional lighting.
Patented convenient installation structure for quick and easy installation.
Dimming: Non-Dimming/TRIAC Dimming.
Adaptable 3" and 4" embedded box mounting.

SPECIFICATIONS

Lamp Body: Made of die-cast aluminum, the material is light and has good heat dissipation.
Power Supply: Constant current power supply, long life, low electromagnetic interference, low energy consumption, high performance, short circuit and overcurrent protection.
Light Source: Using big brand COB lamp beads, color rendering index 80+, 90+ are optional, a variety of color temperature options (3000K, 4000K, 5000K, 6500K).
Mounting plate: Patent structure.

APPLICATIONS

Apply to automotive and parking, education, government, healthcare, hospitality, offices and banks, religious, retail.

LISTING / WARRANTY

ETL listed to US and Canadian standards for damp location W/Feed through.
5 Years Limited Warranty.

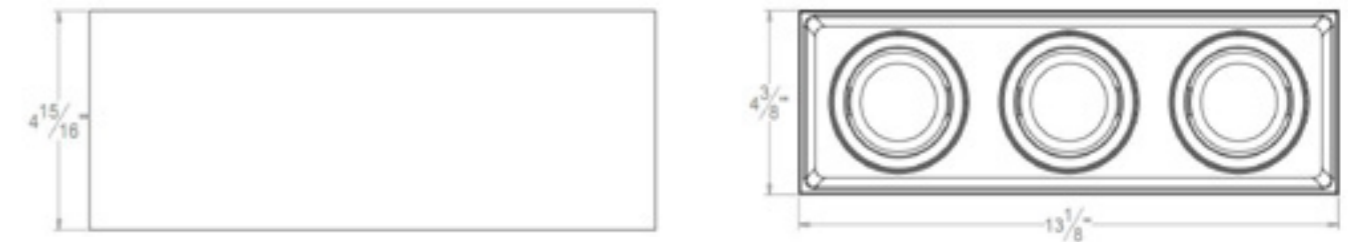
**DIMENSIONS****ORDERING GUIDE / YOUR PRODUCT CODE**

SERIES	LUMEN	VOLTAGE	CCT	CRI	DIMMABLE	FINISH
○ DL4013-S	○ 1680lm	○ AC 120V	○ 2700K	○ 80+	○ NON-Dimmable	○ Black
○ 3 Lamps Surface Mounted LED Downlight	○ 2400lm	○ AC 230V	○ 3000K	○ 90+	○ TRIAC Dimming	○ White
	○ 3750lm	○ AC 277V	○ 4000K			
		○ AC120-277V	○ 5000K			
			○ 6500K			

* Customized Also Available

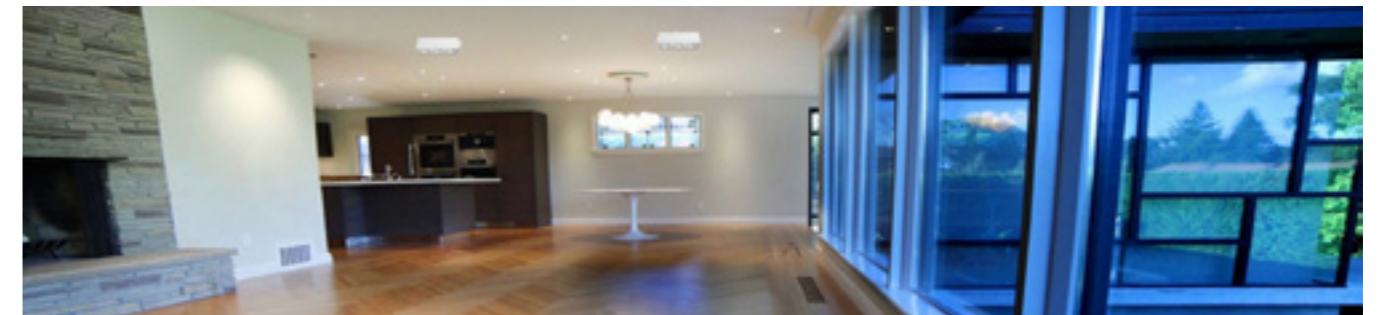

SURFACE MOUNTED SQUARE SHAPE LED DOWNLIGHT WITH 4 LAMPS

DL4014-S

FEATURES

This is a square surface-mounted spotlight that incorporates modern aesthetics. It has a beautifully curved shape, scientific light distribution, good light output, uniform light output, high efficiency and energy saving.

The light source can be adjusted 25° vertically and 360° horizontally to direct the beam in any direction to meet your diverse lighting needs.

The beam angle can be 12°, 24°, and suitable lamps can be selected according to actual needs to provide professional lighting.

Patented convenient installation structure for quick and easy installation.

Dimming: Non-Dimming/TRIAC Dimming.

Adaptable 3" and 4" embedded box mounting.

SPECIFICATIONS

Lamp Body: Made of die-cast aluminum, the material is light and has good heat dissipation.

Power Supply: Constant current power supply, long life, low electromagnetic interference, low energy consumption, high performance, short circuit and overcurrent protection.

Light Source: Using big brand COB lamp beads, color rendering index 80+, 90+ are optional, a variety of color temperature options (3000K, 4000K, 5000K, 6500K).

Mounting plate: Patent structure.

APPLICATIONS

Apply to automotive and parking, education, government, healthcare, hospitality, offices and banks, religious, retail.

LISTING / WARRANTY

ETL listed to US and Canadian standards for damp location W/Feed through.
5 Years Limited Warranty.

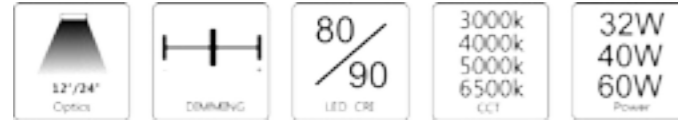

DIMENSIONS



ORDERING GUIDE / YOUR PRODUCT CODE

SERIES	LUMEN	VOLTAGE	CCT	CRI	DIMMABLE	FINISH
DL4014-S	2240lm	AC 120V	2700K	80+	NON-Dimmable	Black
4 Lamps Surface Mounted LED Downlight	3200lm	AC 230V	3000K	90+	TRIAC Dimming	White
	5000lm	AC 277V	4000K			
		AC120-277V	5000K			
			6500K			

* Customized Also Available



SURFACE MOUNTED SQUARE SHAPE LED DOWNLIGHT WITH 2X2 LAMPS

DL4022-S

FEATURES

This is a square surface-mounted spotlight that incorporates modern aesthetics. It has a beautifully curved shape, scientific light distribution, good light output, uniform light output, high efficiency and energy saving.

The light source can be adjusted 25° vertically and 360° horizontally to direct the beam in any direction to meet your diverse lighting needs.

The beam angle can be 12°, 24°, and suitable lamps can be selected according to actual needs to provide professional lighting.

Patented convenient installation structure for quick and easy installation.

Dimming: Non-Dimming/TRIAC Dimming.

Adaptable 3" and 4" embedded box mounting.

SPECIFICATIONS

Lamp Body: Made of die-cast aluminum, the material is light and has good heat dissipation.

Power Supply: Constant current power supply, long life, low electromagnetic interference, low energy consumption, high performance, short circuit and overcurrent protection.

Light Source: Using big brand COB lamp beads, color rendering index 80+, 90+ are optional, a variety of color temperature options (3000K, 4000K, 5000K, 6500K).

Mounting plate: Patent structure.

APPLICATIONS

Apply to automotive and parking, education, government, healthcare, hospitality, offices and banks, religious, retail.

LISTING / WARRANTY

ETL listed to US and Canadian standards for damp location W/Feed through.
5 Years Limited Warranty.



DIMENSIONS



ORDERING GUIDE / YOUR PRODUCT CODE

SERIES	LUMEN	VOLTAGE	CCT	CRI	DIMMABLE	FINISH
DL4022-S	2240lm	AC 120V	2700K	80+	NON-Dimmable	Black
2x2 Lamps Surface Mounted LED Downlight	3200lm	AC 230V	3000K	90+	TRIAC Dimming	White
	5000lm	AC 277V	4000K			
		AC120-277V	5000K			
			6500K			

* Customized Also Available

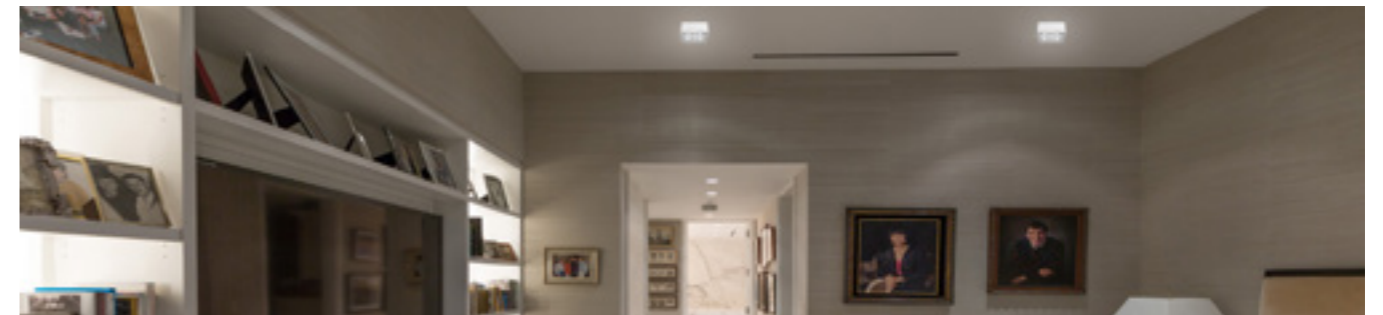

MULTIPLE DOWNLIGHT

Liteharbor Lighting LED multiples combine beautiful aesthetics with optimized performance to set a new benchmark for the category. Featuring a unique patent-pending LED assembly, its novel design enables remarkable tool-free adjustable and locking while maintaining full center beam candle power at all tilt & rotation angles.

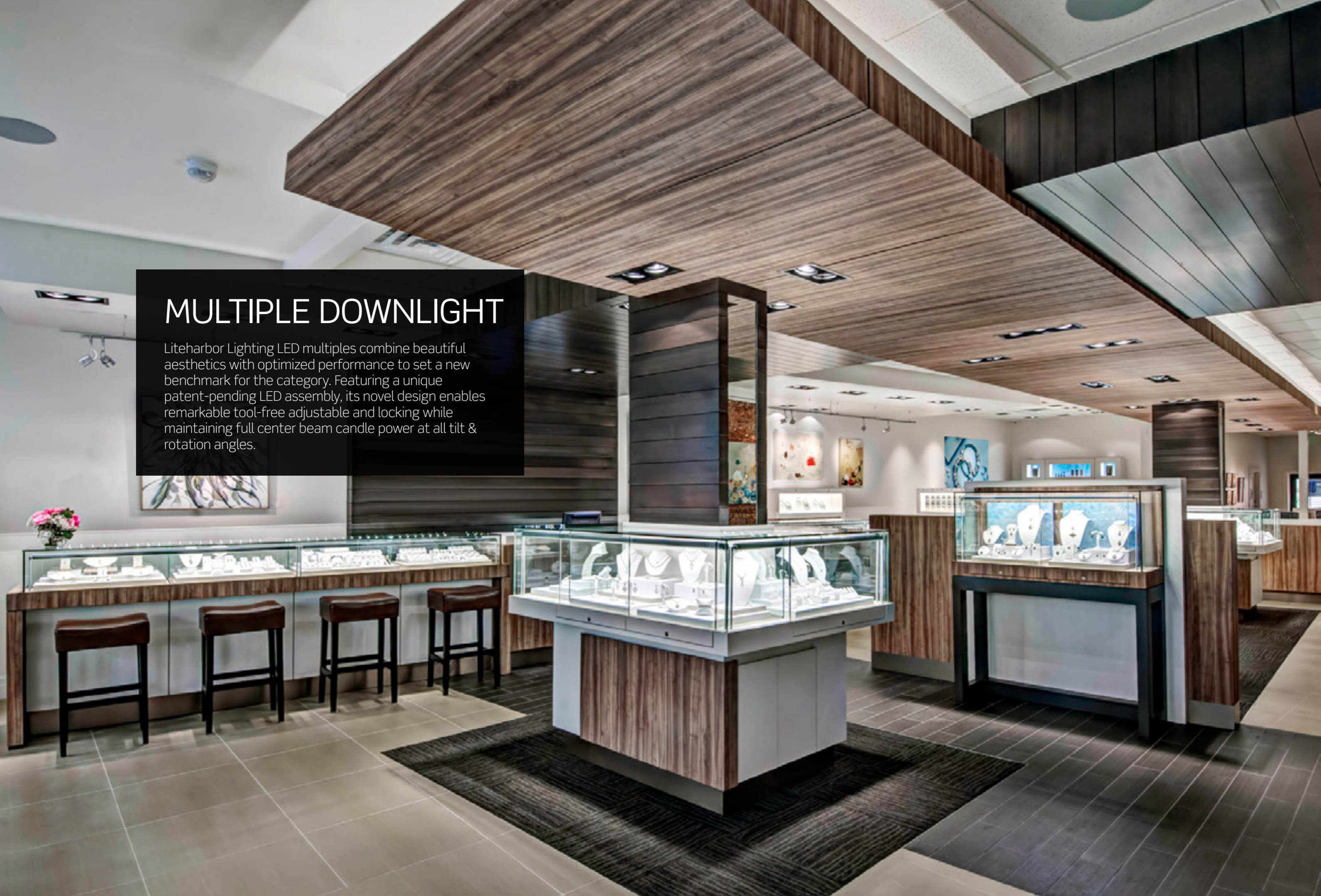

Mini Residential Multiple Light, Light Up Your Home!

Residential Multiples

Liteharbor Residential Multiple Downlight features a patent-pending mini LED spot. The high-end but economical design makes it affordable to any residential application, also have sleek look below the ceiling. Available in 1x1, 1x2, 1x3, 1x4 and 2x2 configurations.

Standard Configurations

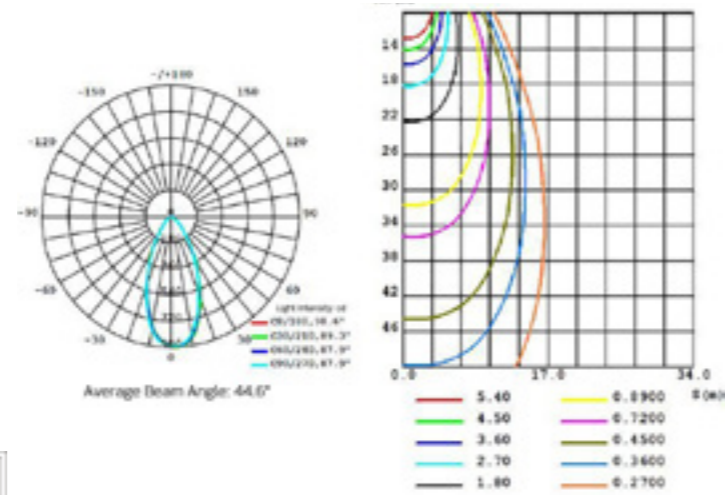

Why is the residential multiple so popular?

- Economical reasonable lowest price
- Mini size to save space and reduce cost
- 1/2/3/4 lights, trim/trimless, face/open trim, providing more options for your home
- High-end sleek look, better to decorate your home
- Different light sources for your choice
- Adjustable design to create more illuminating effect
- Can replace the bulbs without removing the trim



All Liteharbor Multiples are offered with 5-Year limited warranty. A robust sleek design, state-of-the-art engineering and a rigorous testing regimen are all factors that make our products so reliable. All the recessed multiples are cETLus listed. They can be well sold in North America market.



Material
Heavy gauge cold rolled steel housing

Ideal Quick Connector
UL listed Ideal quick connector, invisible wire design to ensure the electrical safety

LED Driver and Cover
The cover separates the driver and connecting wire from the light source. Clip-on design cover for easy maintenance.

Mounting
Universal clips designed for easy installation into existing ceilings

Mesh Plate(Trimless)

Thermally Efficient Heat Sink
LED mounted to die-cast/extruded aluminum heat sink with active cooling, these heatsinks are designed to dissipate heat well below the recommended operating junction temperature.

Adjustability
30° vertical tilt

Reflector Optic

Optic Bezel
Can change the louver to filtering the light, avoid glare.

LED
COB chips can be changed (Chip Brand, CCT, CRI...)

Lens
Can change the lens color for different applications

Mesh Plate (Trimless)

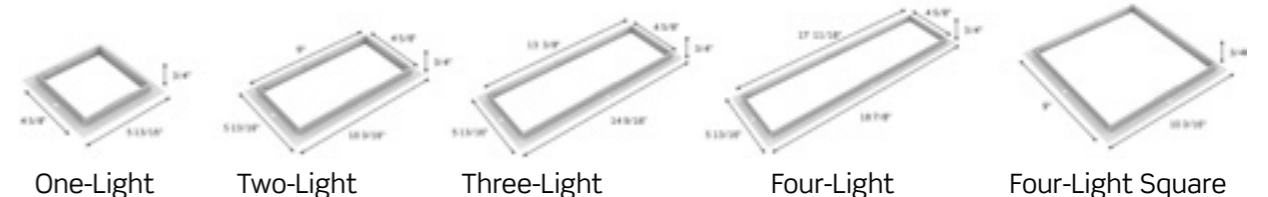

RESIDENTIAL NEW CONSTRUCTION LED GU10 MULTIPLE DOWNLIGHT

LIGHT SOURCE GU10 LED **G401X-E-GU10 Series**



DESCRIPTION

Mini LED Multiple Spots for remodeling and new construction applications for residential and commercial environments. The Multiple Spots are marketed as complete units including the housing and trim. Available as one, two, three and four-light configurations, each spot is individually adjustable and provides a 30-degree visual cutoff for glare control.

MOUNTING

Supplied with 4 ways hanger bar, adjustable from 24 1/2" to accommodate various joist construction and grid sizes. Hanger bars include a captive mounting "screw-nail" for easy installation. Can be accommodate a 1/2" to 1 1/4" ceiling thickness.

FEATURES

Individually adjustable luminaries
Complete unit includes housing & trim
All housings can be made into NON-IC or IC Rated (ETL listed for IC Rated)
30° vertical tilt, 360° horizontal rotation

CONSTRUCTION

Die-cast aluminum heat sink painted black.
Trim and housing are constructed of Gauge Steel.

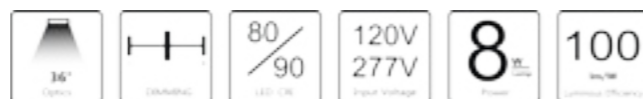

DIMENSIONS

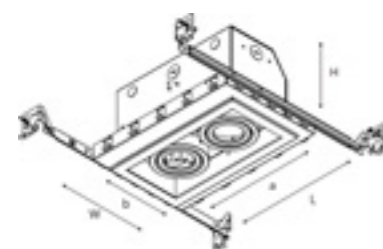

1x1 SPOTS
L: 5 7/8"xW: 6 1/4"xH: 5 1/16"
Cut-Out(axb): 4 3/4" x 4 3/4"

1x3 SPOTS
L: 14 1/2"xW: 6 1/4"xH: 5 1/16"
Cut-Out(axb): 13 1/4" x 4 3/8"

1x4 SPOTS
L: 18 7/8"xW: 6 1/4"xH: 5 1/16"
Cut-Out(axb): 17 7/16" x 4 3/8"

1x2 SPOTS
L: 10 9/16"xW: 6 1/4"xH: 5 1/16"
Cut-Out(axb): 8 3/4" x 4 3/8"

2x2 SPOTS
L: 10 15/16"xW: 10 15/16"xH: 5 1/16"
Cut-Out(axb): 8 3/4" x 8 3/4"

TRIM OPTION

Open Trim



Universal hollow open flanged design

Face Trim/Closed Trim



Special closed flanged design without seeing the body inside

ORDERING GUIDE / YOUR PRODUCT CODE

SERIES	TRIM TYPE	DIMMABLE	CCT	FINISH	EMERGENCY SYSTEM
<input type="radio"/> G4011-E-GU10	<input type="radio"/> Open Trim	<input type="radio"/> NON-Dimmable	<input type="radio"/> 2700K	<input type="radio"/> Black	<input type="radio"/> Without Emergency System
<input type="radio"/> G4012-E-GU10	<input type="radio"/> Face Trim/Closed Trim	<input type="radio"/> Dimmable	<input type="radio"/> 3000K	<input type="radio"/> White	<input type="radio"/> With Emergency System
<input type="radio"/> G4013-E-GU10			<input type="radio"/> 3500K		
<input type="radio"/> G4014-E-GU10	<input type="radio"/> Trimmed		<input type="radio"/> 4000K		
<input type="radio"/> G4014-E-S-GU10	<input type="radio"/> Trimless				

* Customized Also Available

LISTING / WARRANTY

ETL listed to US and Canadian standards for damp location W/Feed through.
5 Years Limited Warranty.



Liteharbor Harbor of Light!

RESIDENTIAL NEW CONSTRUCTION LED COB MULTIPLE DOWNLIGHT

LIGHT SOURCE COB LED **G401X-E-COB Series**



DESCRIPTION

Mini LED Multiple Spots for remodeling and new construction applications for residential and commercial environments. The Multiple Spots are marketed as complete units including the housing and trim. Available as one, two, three and four-light configurations, each spot is individually adjustable and provides a 30-degree visual cutoff for glare control.

MOUNTING

Supplied with 4 ways hanger bar, adjustable from 14 1/2"-25" to accommodate various joist construction and grid sizes. Hanger bars include a captive mounting "screw-nail" for easy installation. Can be accommodate a 1/2" to 1 1/4" ceiling thickness.

FEATURES

Individually adjustable luminaries
Complete unit includes housing & trim
All housings can be made into NON-IC or IC Rated (ETL listed for IC Rated)
30° vertical tilt, 360° horizontal rotation

CONSTRUCTION

Die-cast aluminum heat sink painted black.
Trim and housing are constructed of Gauge Steel.



DIMENSIONS



1x1 SPOTS
L: 9 1/8"xW: 6 1/4"xH: 5 1/8"
Cut-Out(axb): 4 3/4" x 4 3/4"

1x3 SPOTS
L: 17 5/16"xW: 6 1/4"xH: 5 1/8"
Cut-Out(axb): 13 1/4" x 4 3/8"

1x4 SPOTS
L: 21 7/16"xW: 6 1/4"xH: 5 1/8"
Cut-Out(axb): 17 7/16" x 4 3/8"

1x2 SPOTS
L: 13 3/16"xW: 6 1/4"xH: 5 1/8"
Cut-Out(axb): 8 3/4" x 4 3/8"

2x2 SPOTS
L: 10 15/16"xW: 10 15/16"xH: 5 1/8"
Cut-Out(axb): 8 3/4" x 8 3/4"

TRIM OPTION

Open Trim



Universal hollow open flanged design

Face Trim/Closed Trim



Special closed flanged design without seeing the body inside

ORDERING GUIDE / YOUR PRODUCT CODE

SERIES	TRIM TYPE	DIMMABLE	CCT	FINISH	EMERGENCY SYSTEM
<input type="radio"/> G4011-E-COB	<input type="radio"/> Open Trim	<input type="radio"/> NON-Dimmable	<input type="radio"/> 2700K	<input type="radio"/> Black	<input type="radio"/> Without Emergency System
<input type="radio"/> G4012-E-COB	<input type="radio"/> Face Trim/Closed Trim	<input type="radio"/> Dimmable	<input type="radio"/> 3000K	<input type="radio"/> White	<input type="radio"/> With Emergency System
<input type="radio"/> G4013-E-COB			<input type="radio"/> 3500K		
<input type="radio"/> G4014-E-COB	<input type="radio"/> Trimmed		<input type="radio"/> 4000K		
<input type="radio"/> G4014-E-S-COB	<input type="radio"/> Trimless				

* Customized Also Available

LISTING / WARRANTY

ETL listed to US and Canadian standards for damp location W/Feed through.
5 Years Limited Warranty.

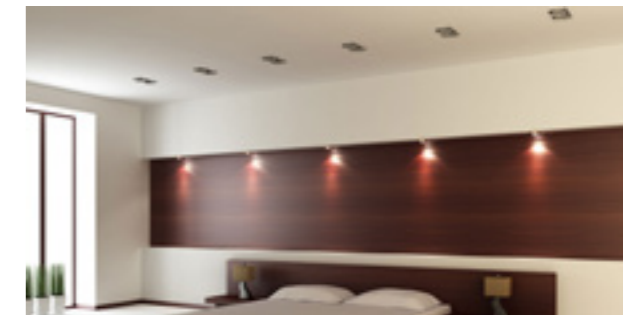

E-mail:info@liteharbor.com

TRIM OR TRIMLESS REMODEL LED GU10 MULTIPLE DOWNLIGHT

G401X-E-R-GU10 Series

DESCRIPTION

Mini LED Multiple Spots for remodeling and new construction applications for residential and commercial environments. The Multiple Spots are marketed as complete units including the housing and trim. Available as one, two, three and four-light configurations, each spot is individually adjustable and provides a 30-degree visual cutoff for glare control.

FEATURES

Individually adjustable luminaries
Complete unit includes housing & trim
All housings can be made into NON-IC or IC Rated (ETL listed for IC Rated)
30° vertical tilt, 360° horizontal rotation

MOUNTING

Available in 12.7mm-38.1mm thick ceilings
Fix the lamp by locking screw from below the ceiling
When installing or removing the fixture, it won't damage the ceilings

CONSTRUCTION

Trim and housing are constructed of Gauge Steel.

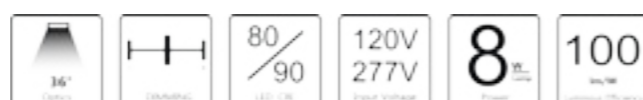

DIMENSIONS

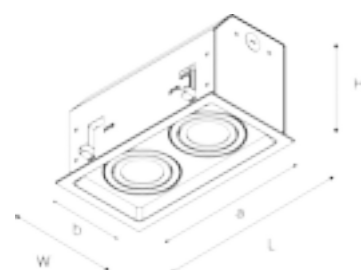

1x1 SPOTS
L: 5"xW: 5"xH: 5"
Cut-Out(axb): 4 1/4" x 4 1/4"

1x2 SPOTS
L: 9 5/16"xW: 5"xH: 5"
Cut-Out(axb): 8 3/4" x 4 1/4"

1x3 SPOTS
L: 13 3/4"xW: 5"xH: 5"
Cut-Out(axb): 13" x 4 1/4"

1x4 SPOTS
L: 17 7/8"xW: 5"xH: 5"
Cut-Out(axb): 17 7/16" x 4 1/4"

TRIM OPTION

Open Trim



Universal hollow open flanged design

Face Trim/Closed Trim



Special closed flanged design without seeing the body inside

ORDERING GUIDE / YOUR PRODUCT CODE

SERIES	TRIM TYPE	DIMMABLE	CCT	FINISH	EMERGENCY SYSTEM
<input type="radio"/> G4011-E-R-GU10	<input type="radio"/> Open Trim	<input type="radio"/> NON-Dimmable	<input type="radio"/> 2700K	<input type="radio"/> Black	<input type="radio"/> Without Emergency System
<input type="radio"/> G4012-E-R-GU10	<input type="radio"/> Face Trim/Closed Trim	<input type="radio"/> Dimmable	<input type="radio"/> 3000K	<input type="radio"/> White	<input type="radio"/> With Emergency System
<input type="radio"/> G4013-E-R-GU10			<input type="radio"/> 3500K		
<input type="radio"/> G4014-E-R-GU10			<input type="radio"/> 4000K		

* Customized Also Available

LISTING / WARRANTY

ETL listed to US and Canadian standards for damp location W/Feed through.
5 Years Limited Warranty.



Liteharbor Harbor of Light!

TRIM OR TRIMLESS REMODEL LED COB MULTIPLE DOWNLIGHT

G401X-E-R-COB Series

DESCRIPTION

Mini LED Multiple Spots for remodeling and new construction applications for residential and commercial environments. The Multiple Spots are marketed as complete units including the housing and trim. Available as one, two, three and four-light configurations, each spot is individually adjustable and provides a 30-degree visual cutoff for glare control.

FEATURES

Individually adjustable luminaries
Complete unit includes housing & trim
All housings can be made into NON-IC or IC Rated (ETL listed for IC Rated)
30° vertical tilt, 360° horizontal rotation

MOUNTING

Available in 12.7mm-38.1mm thick ceilings
Fix the lamp by locking screw from below the ceiling
When installing or removing the fixture, it won't damage the ceilings

CONSTRUCTION

Die-cast aluminum heat sink painted white.
Trim and housing are constructed of Gauge Steel.

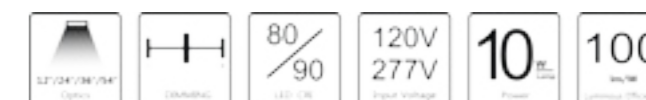

DIMENSIONS

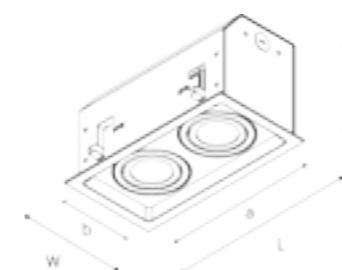

1x1 SPOTS
L: 5"xW: 5"xH: 5"
Cut-Out(axb): 4 1/4" x 4 1/4"

1x2 SPOTS
L: 9 5/16"xW: 5"xH: 5"
Cut-Out(axb): 8 3/4" x 4 1/4"

1x3 SPOTS
L: 13 3/4"xW: 5"xH: 5"
Cut-Out(axb): 13" x 4 1/4"

1x4 SPOTS
L: 17 7/8"xW: 5"xH: 5"
Cut-Out(axb): 17 7/16" x 4 1/4"

TRIM OPTION

Open Trim



Universal hollow open flanged design

Face Trim/Closed Trim



Special closed flanged design without seeing the body inside

ORDERING GUIDE / YOUR PRODUCT CODE

SERIES	TRIM TYPE	DIMMABLE	CCT	FINISH	EMERGENCY SYSTEM
<input type="radio"/> G4011-E-R-COB	<input type="radio"/> Open Trim	<input type="radio"/> NON-Dimmable	<input type="radio"/> 2700K	<input type="radio"/> Black	<input type="radio"/> Without Emergency System
<input type="radio"/> G4012-E-R-COB	<input type="radio"/> Face Trim/Closed Trim	<input type="radio"/> Dimmable	<input type="radio"/> 3000K	<input type="radio"/> White	<input type="radio"/> With Emergency System
<input type="radio"/> G4013-E-R-COB			<input type="radio"/> 3500K		
<input type="radio"/> G4014-E-R-COB			<input type="radio"/> 4000K		

* Customized Also Available

LISTING / WARRANTY

ETL listed to US and Canadian standards for damp location W/Feed through.
5 Years Limited Warranty.



E-mail:info@liteharbor.com

RESIDENTIAL REMODEL LED GU10 MULTIPLE DOWNLIGHT

LIGHT SOURCE GU10 LED **G401X-F-GU10 Series**



DESCRIPTION

Mini LED Multiple Spots for remodeling and new construction applications for residential and commercial environments. The Multiple Spots are marketed as complete units including the housing and trim (trimless available). Available as one, two and three-light configurations, each spot is individually adjustable and provides a 30-degree visual cutoff for glare control.

FEATURES

Individually adjustable luminaries
 Complete unit includes housing & trim
 All housings can be made into NON-IC or IC Rated (ETL listed for IC Rated)
 30° vertical tilt, 360° horizontal rotation

CONSTRUCTION

Die-cast aluminum heat sink painted black.
 Trim and housing are constructed of Gauge Steel.

Junction Box

Seven knockouts and four Romex (R) style wiring connectors provided for ease of installation. Rated for branch wiring.



DIMENSIONS

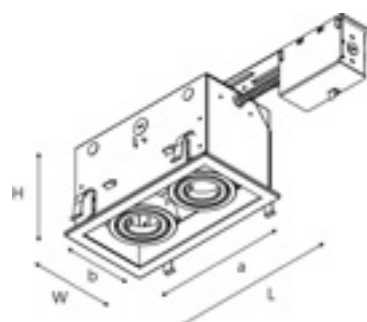

1x1 SPOTS
 L: 12 3/16"xW: 5"xH: 5 1/16"
 Cut-Out(axb): 4 1/4" x 4 1/4"

1x2 SPOTS
 L: 16 1/2"xW: 5"xH: 5 1/16"
 Cut-Out(axb): 8 3/4" x 4 1/4"

1x3 SPOTS
 L: 19 15/16"xW: 5"xH: 5 1/16"
 Cut-Out(axb): 13" x 4 1/4"

TRIM OPTION

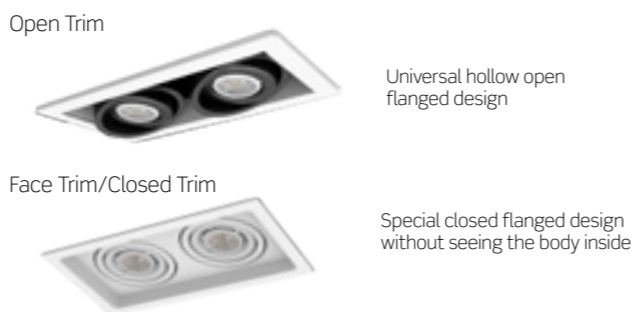

ORDERING GUIDE / YOUR PRODUCT CODE

SERIES	TRIM TYPE	DIMMABLE	CCT	FINISH	EMERGENCY SYSTEM
<input type="radio"/> G401 1-F-GU10	<input type="radio"/> Open Trim	<input type="radio"/> NON-Dimmable	<input type="radio"/> 2700K	<input type="radio"/> Black	<input type="radio"/> Without Emergency System
<input type="radio"/> G401 2-F-GU10	<input type="radio"/> Face Trim/Closed Trim	<input type="radio"/> Dimmable	<input type="radio"/> 3000K	<input type="radio"/> White	<input type="radio"/> With Emergency System
<input type="radio"/> G401 3-F-GU10			<input type="radio"/> 3500K		
			<input type="radio"/> 4000K		

* Customized Also Available

LISTING / WARRANTY

ETL listed to US and Canadian standards for damp location W/Feed through.
 5 Years Limited Warranty.



RESIDENTIAL REMODEL LED COB MULTIPLE DOWNLIGHT

LIGHT SOURCE COB LED **G401X-F-COB Series**



DESCRIPTION

Mini LED Multiple Spots for remodeling and new construction applications for residential and commercial environments. The Multiple Spots are marketed as complete units including the housing and trim (trimless available). Available as one, two and three-light configurations, each spot is individually adjustable and provides a 30-degree visual cutoff for glare control.

FEATURES

Individually adjustable luminaries
 Complete unit includes housing & trim
 All housings can be made into NON-IC or IC Rated (ETL listed for IC Rated)
 30° vertical tilt, 360° horizontal rotation

CONSTRUCTION

Die-cast aluminum heat sink painted black.
 Trim and housing are constructed of Gauge Steel.

Junction Box

Seven knockouts and four Romex (R) style wiring connectors provided for ease of installation. Rated for branch wiring.

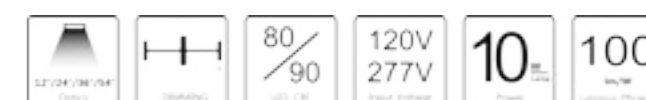

DIMENSIONS

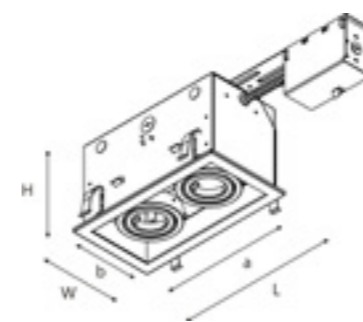

1x1 SPOTS
 L: 12 3/16"xW: 5"xH: 5 1/16"
 Cut-Out(axb): 4 1/4" x 4 1/4"

1x2 SPOTS
 L: 16 1/2"xW: 5"xH: 5 1/16"
 Cut-Out(axb): 8 3/4" x 4 1/4"

1x3 SPOTS
 L: 19 15/16"xW: 5"xH: 5 1/16"
 Cut-Out(axb): 13" x 4 1/4"

TRIM OPTION



ORDERING GUIDE / YOUR PRODUCT CODE

SERIES	TRIM TYPE	DIMMABLE	CCT	FINISH	EMERGENCY SYSTEM
<input type="radio"/> G4011-F-COB	<input type="radio"/> Open Trim	<input type="radio"/> NON-Dimmable	<input type="radio"/> 2700K	<input type="radio"/> Black	<input type="radio"/> Without Emergency System
<input type="radio"/> G4012-F-COB	<input type="radio"/> Face Trim/Closed Trim	<input type="radio"/> Dimmable	<input type="radio"/> 3000K	<input type="radio"/> White	<input type="radio"/> With Emergency System
<input type="radio"/> G4013-F-COB			<input type="radio"/> 3500K		
			<input type="radio"/> 4000K		

* Customized Also Available

LISTING / WARRANTY

ETL listed to US and Canadian standards for damp location W/Feed through.
 5 Years Limited Warranty.





COMMERCIAL MULTIPLES

The recessed multihead luminaire provides the designer with a wealth of accent and display illumination tools in one small box. Packed with features such as horizontal travel, trim or trimless installation, this is truly one of the most versatile recessed products in the architectural lighting industry.

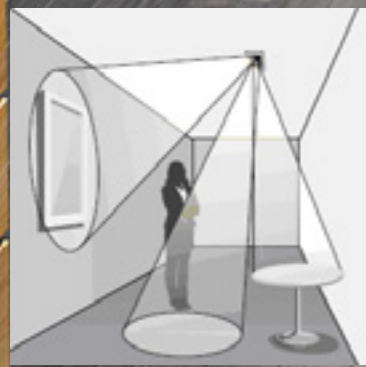

Liteharbor commercial multiples allow complete control of the positioning of individual LED heads. Even varied beam angles and CCT/CRI options can be selected within each fixture head if desired.

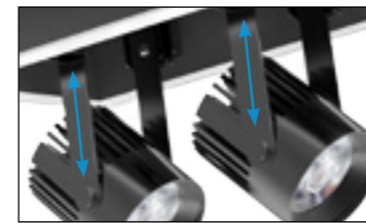

Retractable Head

Can be fully recessed head that allow for higher aiming angles

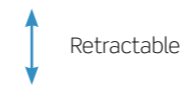

Customization

Die-cast aluminum heat sink painted white, black, silver or customized finish



Rotation

Allow for vertical 90 degree rotation
Allow for horizontal 368 degree rotation

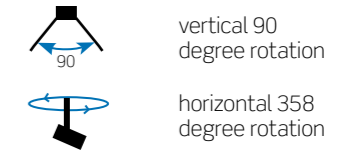

COMMERCIAL LED MULTIPLE DOWNLIGHT

G401X-A Series



DESCRIPTION

Easy installation and maintenance
 All parts and components accessible from below the ceiling
 Lamp holders are adjustable 360° horizontal and 30° vertical for spot lighting in multiple directions
 Actual adjustment may vary depending on the lamp beam spread

LIGHT SOURCE & SOCKET	INPUT VOLT.	WATTAGE	COLOR TEMPERATURE	LIFE SPAN
LED COB	120V 277V 120-277V	20W Max	2700-6000K	50000h
LED PAR20/ E26		10W Max		
LED PAR30/ E26		18W Max		
LED AR111/ G53		33W Max		

FLANGED TRIM

Extruded trim frame includes torsion springs for convenient installations or removal from the housing

TRIMLESS

Optional mud frame available for trimless mounting
 The perforated mesh frame provided adheres to joint compound for seamless and trimless mounting

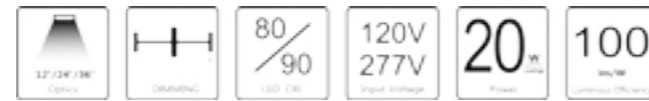

DIMENSIONS

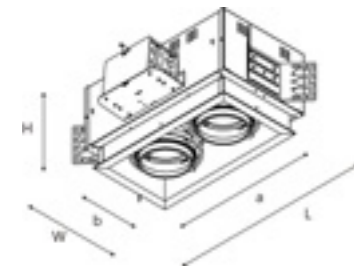

1x1 SPOTS
 L: 13 1/8"xW: 12 3/16"xH: 7 9/16"
 Cut-Out(axb): 7 9/16" x 7 9/16"

1x3 SPOTS
 L: 26 3/16"xW: 12 3/16"xH: 7 9/16"
 Cut-Out(axb): 20 1/2" x 7 9/16"

1x4 SPOTS
 L: 31 7/16"xW: 12 3/16"xH: 7 9/16"
 Cut-Out(axb): 26 13/16" x 7 9/16"

1x2 SPOTS
 L: 19 1/2"xW: 12 3/16"xH: 7 9/16"
 Cut-Out(axb): 13 9/16" x 7 9/16"

2x2 SPOTS
 L: 21"xW: 20 3/16"xH: 7 5/8"
 Cut-Out(axb): 14 7/16" x 14 7/16"

TRIM OPTION

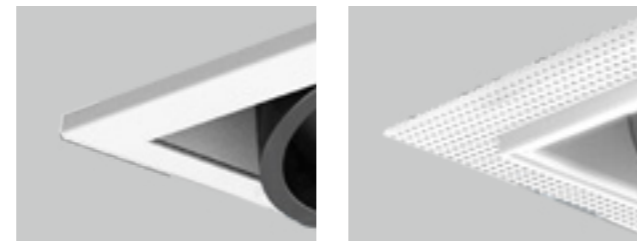

Trimmed

Trimless

ORDERING GUIDE / YOUR PRODUCT CODE

SERIES	LIGHT SOURCE	TRIM TYPE	DIMMABLE	CCT	FINISH	EMERGENCY SYSTEM
<input type="radio"/> G4011-A	<input type="radio"/> LED COB	<input type="radio"/> Trimmed	<input type="radio"/> NON-Dimmable	<input type="radio"/> 2700K	<input type="radio"/> Black	<input type="radio"/> Without Emergency System
<input type="radio"/> G4012-A	<input type="radio"/> LED PAR20	<input type="radio"/> Trimless	<input type="radio"/> Dimmable	<input type="radio"/> 3000K	<input type="radio"/> White	<input type="radio"/> With Emergency System
<input type="radio"/> G4013-A	<input type="radio"/> LED PAR30			<input type="radio"/> 3500K		
<input type="radio"/> G4014-A	<input type="radio"/> LED AR111			<input type="radio"/> 4000K		
<input type="radio"/> G4014-A-S						

* Customized Also Available

LISTING / WARRANTY

ETL listed to US and Canadian standards for damp location W/Feed through.
 5 Years Limited Warranty.



Liteharbor Harbor of Light!

COMMERCIAL LED COB MULTIPLE DOWNLIGHT

G401X-B Series



DESCRIPTION

Easy installation and maintenance
 All parts and components accessible from below the ceiling
 Lamp holders are adjustable 360° horizontal and 30° vertical for spot lighting in multiple directions
 Actual adjustment may vary depending on the lamp beam spread

HOUSING

The inner trim is constructed of 22 GA steel
 Finish can be black, white or silver
 Special finish please confirm with factory
 Internal wire bundles and locked and covered with a glass sleeve
 Junction box can be accessible from below the ceiling with a plate

FLANGED TRIM

Extruded trim frame includes torsion springs for convenient installations or removal from the housing

MOUNTING FRAME

Can be accommodate a 1/2" to 1 1/4" ceiling thickness
 Channel bracket allow up to 5" vertical adjustable
 Universal mounting brackets included
 Compatible with C-channel, flat bar, and EMT
 C-channel are recommended for T-bar ceilings
 Bar hangers must be ordered separately



DIMENSIONS

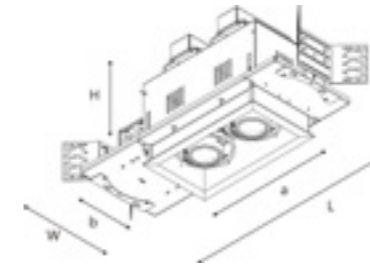

1x2 SPOTS
 L: 21 1/8"xW: 8 9/16"xH: 8 11/16"
 Cut-Out(axb): 11 1/4" x 6 1/4"

1x1 SPOTS
 L: 15 7/8"xW: 8 9/16"xH: 8 11/16"
 Cut-Out(axb): 6 1/4" x 6 1/4"

1x3 SPOTS
 L: 26 1/4"xW: 8 9/16"xH: 8 11/16"
 Cut-Out(axb): 16 5/8" x 6 1/4"

1x4 SPOTS
 L: 31 5/16"xW: 8 9/16"xH: 8 11/16"
 Cut-Out(axb): 21 3/4" x 6 1/4"

2x2 SPOTS
 L: 21"xW: 13 3/4"xH: 8 11/16"
 Cut-Out(axb): 11 7/16" x 11 7/16"

TRIM OPTION

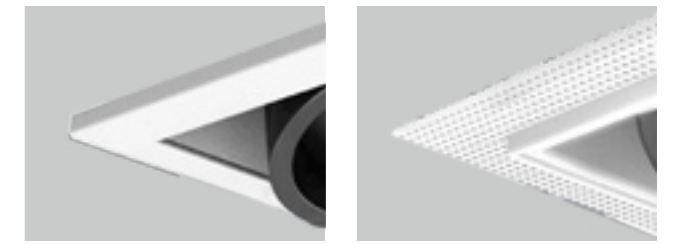

Trimmed

Trimless

ORDERING GUIDE / YOUR PRODUCT CODE

SERIES	OPTIC	TRIM	DIMMABLE	CCT	FINISH	EMERGENCY SYSTEM
<input type="radio"/> G4011-B	<input type="radio"/> 12° Spot	<input type="radio"/> Trimmed	<input type="radio"/> NON-Dimmable	<input type="radio"/> 2700K	<input type="radio"/> Black	<input type="radio"/> Without Emergency System
<input type="radio"/> G4012-B	<input type="radio"/> 24° Narrow Flood	<input type="radio"/> Trimless	<input type="radio"/> Dimmable	<input type="radio"/> 3000K	<input type="radio"/> White	<input type="radio"/> With Emergency System
<input type="radio"/> G4013-B	<input type="radio"/> 36° Flood			<input type="radio"/> 3500K		
<input type="radio"/> G4014-B				<input type="radio"/> 4000K		
<input type="radio"/> G4014-B-S						

* Customized Also Available

LISTING / WARRANTY

ETL listed to US and Canadian standards for damp location W/Feed through.
 5 Years Limited Warranty.



E-mail:info@liteharbor.com

COMMERCIAL RGBW LED COB MULTIPLE DOWNLIGHT

LIGHT SOURCE COB LED **G401X-C Series**

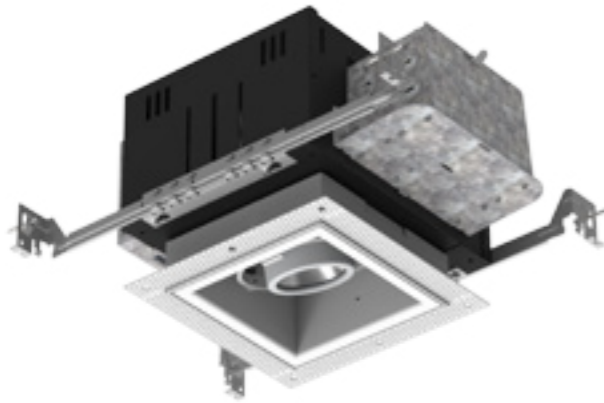

DESCRIPTION

RGBW state of the art down light
Compatible with 512 universal controllers in the market
The floating head permits trim adjustable of angles and direction of beam
Imagine creating ANY COLOR your mood desires just by press of a button
Regular lighting/ Reading mode/ Color changing/ Party mode
DMX 512 controller needed. Sold separately

APPLICATION

High end residence and Commercial applications
Hotel
Casino
Photo Studio
Art gallery
Film studio
Film set

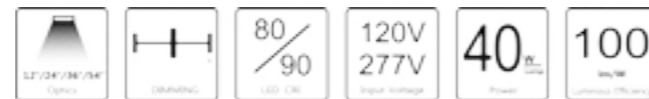

SINGLE COLOR SYSTEM



FULL COLOR SYSTEM

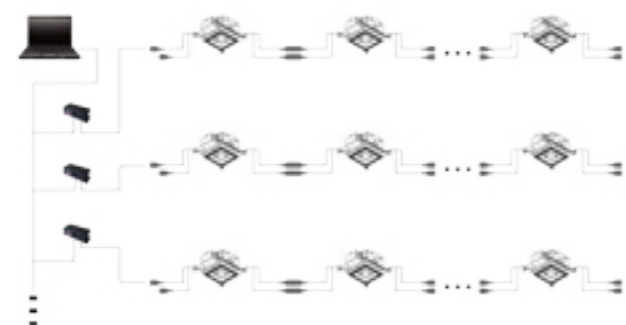

TRIM OPTION

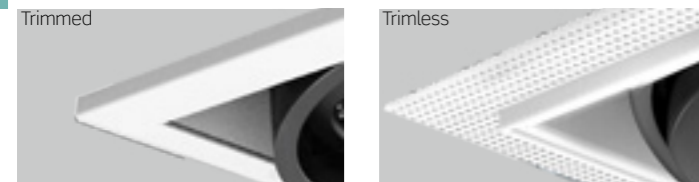

DIMENSIONS

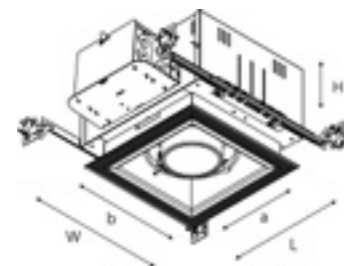

- 1x1 SPOTS**
L: 9"xW: 12 3/16"xH: 7 9/16"
Cut-Out(axb): 7 9/16" x 7 9/16"
- 1x3 SPOTS**
L: 21 7/8"xW: 12 3/16"xH: 5 1/16"
Cut-Out(axb): 20 1/2" x 7 9/16"
- 1x4 SPOTS**
L: 28 5/16"xW: 12 3/16"xH: 7 9/16"
Cut-Out(axb): 26 13/16" x 7 9/16"
- 1x2 SPOTS**
L: 15 7/16"xW: 12 3/16"xH: 7 9/16"
Cut-Out(axb): 13 9/16" x 7 9/16"
- 2x2 SPOTS**
L: 15 7/16"xW: 12 3/16"xH: 7 9/16"
Cut-Out(axb): 13 9/16" x 13 9/16"

ORDERING GUIDE / YOUR PRODUCT CODE

SERIES	TYPE	TRIM	DIMMABLE	CCT	FINISH	EMERGENCY SYSTEM
<input type="radio"/> G4011-C	<input type="radio"/> RGB	<input type="radio"/> Trimmed	<input type="radio"/> NON-Dimmable	<input type="radio"/> 2700K	<input type="radio"/> Black	<input type="radio"/> Without Emergency System
<input type="radio"/> G4012-C	<input type="radio"/> RGBW	<input type="radio"/> Trimless	<input type="radio"/> Dimmable	<input type="radio"/> 3000K	<input type="radio"/> White	<input type="radio"/> With Emergency System
<input type="radio"/> G4013-C	<input type="radio"/> CW=5000K			<input type="radio"/> 3500K		
<input type="radio"/> G4014-C	<input type="radio"/> WW=2700K			<input type="radio"/> 4000K		
<input type="radio"/> G4014-C-S						

* Customized Also Available

LISTING / WARRANTY

ETL listed to US and Canadian standards for damp location W/Feed through.
5 Years Limited Warranty.

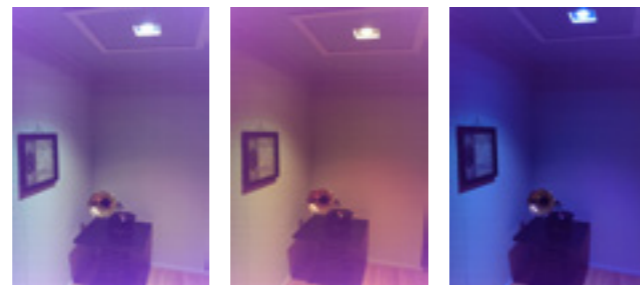

COMMERCIAL RETRACTABLE LED COB MULTIPLE DOWNLIGHT

LIGHT SOURCE COB LED **G401X-D1 Series**



DESCRIPTION

Pull LED Trim and Trimless Multiple Recessed Downlights
Offered in 4 configurations: 1-light; 2-light; 3-light; and 4-light
Can be fully recessed or semi recessed heads that allow for higher aiming angles
Allow for 30-degrees across, with a 45-degree tilt and a 360-plus degree rotation.

MOUNTING

Luminaire can accommodate up to 1" ceiling thickness.
Luminaire is supplied with butterfly brackets to allow up-to 3" vertical adjustment.
Compatible with C-channel, flat bar, wood joist bar and EMT. Bar hangers must be ordered separately.
C-channel is recommended for T-bar ceilings.

J-BOX

Seven knockouts and four Romex® style wiring connectors provided for ease of installation.
Rated for branch wiring.

CONSTRUCTION

Die-cast aluminum heat sink painted white, black, silver or customized finish.
Trim, housing and junction box are 20 gauge steel.
Frame and hanger bars are heavy gauge galvanized steel.



- G4011-D1
- G4012-D1
- G4013-D1

- G4014-D1
- G4014-D1-S

DIMENSIONS

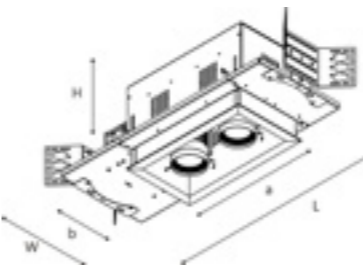

- 1x1 SPOTS**
L: 15 7/8"xW: 8 9/16"xH: 7 11/16"
Cut-Out(axb): 6 1/4" x 6 1/4"
- 1x3 SPOTS**
L: 26 1/4"xW: 8 9/16"xH: 7 11/16"
Cut-Out(axb): 16 5/8" x 6 1/4"
- 1x4 SPOTS**
L: 31 5/16"xW: 8 9/16"xH: 7 11/16"
Cut-Out(axb): 21 3/4" x 6 1/4"
- 1x2 SPOTS**
L: 21 1/8"xW: 8 9/16"xH: 7 11/16"
Cut-Out(axb): 11 1/4" x 6 1/4"
- 2x2 SPOTS**
L: 21"xW: 8 9/16"xH: 7 11/16"
Cut-Out(axb): 11 7/16" x 11 7/16"

TRIM OPTION

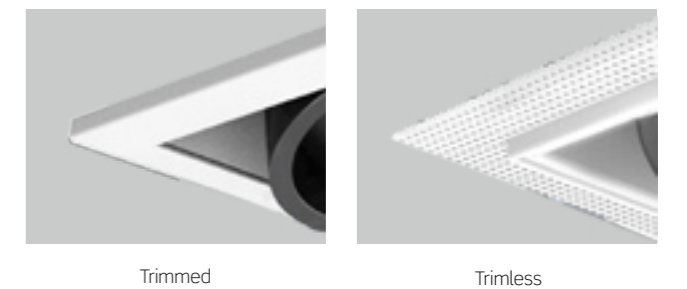

ORDERING GUIDE / YOUR PRODUCT CODE

SERIES	OPTIC	TRIM	DIMMABLE	CCT	FINISH	EMERGENCY SYSTEM
<input type="radio"/> G4011-D1	<input type="radio"/> 12° Spot	<input type="radio"/> Trimmed	<input type="radio"/> NON-Dimmable	<input type="radio"/> 2700K	<input type="radio"/> Black	<input type="radio"/> Without Emergency System
<input type="radio"/> G4012-D1	<input type="radio"/> 24° Narrow Flood	<input type="radio"/> Trimless	<input type="radio"/> Dimmable	<input type="radio"/> 3000K	<input type="radio"/> White	<input type="radio"/> With Emergency System
<input type="radio"/> G4013-D1	<input type="radio"/> 36° Flood			<input type="radio"/> 3500K		
<input type="radio"/> G4014-D1				<input type="radio"/> 4000K		
<input type="radio"/> G4014-D1-S						

* Customized Also Available

LISTING / WARRANTY

ETL listed to US and Canadian standards for damp location W/Feed through.
5 Years Limited Warranty.



WALL WASH LED MULTIPLE DOWNLIGHT

LIGHT SOURCE SMD CHIPS **G401X-E-W Series**



DESCRIPTION

Ideal for retail, hospitality, lobby, residential or commercial space
 Break the proportions and limits of spaces
 No unpleasant dark areas near the ceiling
 Enhance the objects on the wall
 Makes the room appear larger and more spacious
 It is ideal for creating a visually smooth, flat surface
 Also be ideal for creating a textured surface

FEATURES

Recessed multiple downlight
 4-Way hanger bar for ease installation
 Gauge steel housing
 Accommodate to 1/2" to 1 1/4" thick ceiling

PERFORMANCE ADVANTAGES

Break the proportions and limits of spaces
 No unpleasant dark areas near the ceiling
 Enhance the objects on the wall
 Makes the room appear larger and more spacious
 It is ideal for creating a visually smooth, flat surface
 Also be ideal for creating a textured surface



G4012-E-W G4013-E-W G4014-E-W

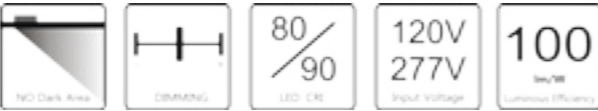

DIMENSIONS

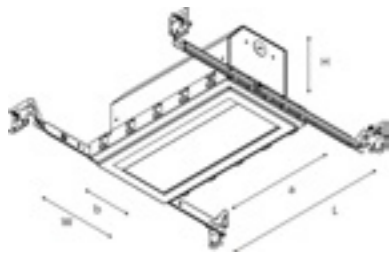

Size: G4012-E-W
 L: 10 9/16"xW: 6 1/4"xH: 5 1/16"
 Cut-Out(axb): 8 3/4" x 4 3/8"

Size: G4013-E-W
 L: 14 1/2"xW: 6 1/4"xH: 5 1/16"
 Cut-Out(axb): 13 1/4" x 4 3/8"

Size: G4014-E-W
 L: 18 7/8"xW: 6 1/4"xH: 5 1/16"
 Cut-Out(axb): 17 7/16" x 4 3/8"

TRIM OPTION

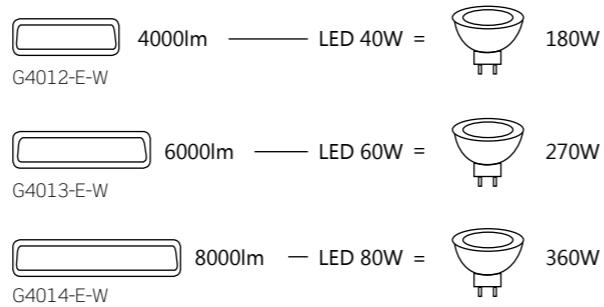

ORDERING GUIDE / YOUR PRODUCT CODE

SERIES	DIMMABLE	CCT	FINISH	EMERGENCY SYSTEM
<input type="radio"/> G4012-E-W	<input type="radio"/> NON-Dimmable	<input type="radio"/> 2700K	<input type="radio"/> Black	<input type="radio"/> Without Emergency System
<input type="radio"/> G4013-E-W	<input type="radio"/> Dimmable	<input type="radio"/> 3000K	<input type="radio"/> White	<input type="radio"/> With Emergency System
<input type="radio"/> G4014-E-W		<input type="radio"/> 3500K		
		<input type="radio"/> 4000K		

* Customized Also Available

A wide range, ideal for illuminating vertical walls in commercial and professional environments.

LISTING / WARRANTY

ETL listed to US and Canadian standards for damp location W/Feed through.
 5 Years Limited Warranty.

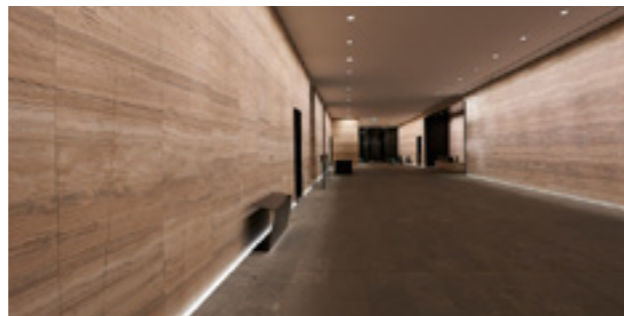

Pressable Trimmed & Trimless Miniature LED Recessed Downlight Series

This Product is the lighting embodiment of miniature, recessed LED solutions for residential and hospitality venues and boutiques. Available in a lot of shapes, frames, colors and accessories, as a straight or a symmetrical spot, or as general lighting, and it's combines choice with exclusive design and high-quality lighting technology.

SMALL SIZE, BIG FLAVOUR



2 TYPES OF TRIM



Trimmed



Trimless

This Product is the lighting embodiment of miniature, recessed LED solutions for residential and hospitality venues and boutiques. Available in a lot of shapes, frames, colors and accessories, as a straight or a symmetrical spot, or as general lighting, and it's combines choice with exclusive design and high-quality lighting technology.

Colors Combinations



Option 1: White



Option 2: Black



Option 3: Brown

6 LED Module Option



Round In



Square In

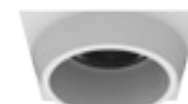

Round Tapered



Square Tapered



Round Out



Square Out

Dual Positioning



First Position



Second Position

- A lot of shapes, frames and colors, providing more options for you
- Available in 1, 2, 3, 4, 5, 6, 7, 8 lamps.
- Beam Angle: 12/24/36/60/90 Degrees

Trimless Linkable Lamps Options



Option 1: 1 Lamp



Option 2: 2 Lamps



Option 3: 3 Lamps



Option 4: 4 Lamps



Option 5: 6 Lamps(L-shaped)
*(5/7/8 Lamps are also available)



All Liteharbor downlights are offered with 5-Year limited warranty. A robust sleek design, state-of-the-art engineering and a rigorous testing regimen are all factors that make our products so reliable. All the recessed multiples are cETLus listed. They can be well sold in North America market.

PRESSABLE TRIMMED OR TRIMLESS MINIATURE MULTIPLE LED RECESSED DOWNLIGHT

LIGHT SOURCE COB LED XL-002-R Series



DESCRIPTION

This Product is the lighting embodiment of miniature, recessed LED solutions for residential and hospitality venues and boutiques. Available in a lot of shapes, frames, colors and accessories, as a straight or a symmetrical spot, or as general lighting, and it's combines choice with exclusive design and high-quality lighting technology.

FEATURES

The choice combines exclusive design with high quality lighting technology. A lot of shapes, frames and colors, providing more options for you. Available in 1,2, 3, 4 lamps. Beam Angle: 12/24/36/60/90 Degrees. Life Rated for 50,000 hours at 70% lumen maintenance. Easy installation.

APPLICATIONS

Suitable for jewelry stores, boutiques, luxury goods stores, shopping malls and other places that require concentrated lighting and accent lighting.

COVER COLOR OPTION



White Black Brown

* Customized is available

TRIM OPTION



Trimmed Trimless



XL-002-R-1-TL XL-002-R-2-TL XL-002-R-3-TL XL-002-R-4-TL

Beam Angle	2700k 4000k	80 90	AC 120V 277V 120-277V	6W	480lm 600lm
------------	----------------	----------	-----------------------------	----	----------------

DIMENSIONS

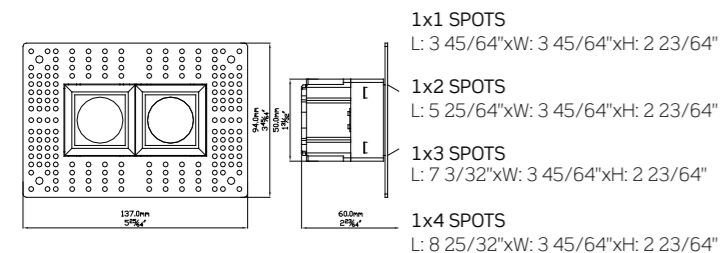

ORDERING GUIDE / YOUR PRODUCT CODE

SERIES/LUMEN	INPUT VOLTAGE	CCT	CRI	DIMMABLE	BEAM ANGLE	TRIM TYPE	FINISH
<input type="radio"/> XL-002-R-1	<input type="radio"/> AC 120V	<input type="radio"/> 2700K	<input type="radio"/> 80+	<input type="radio"/> Dimmable	<input type="radio"/> 12°	<input type="radio"/> Trimmed	<input type="radio"/> Black
<input type="radio"/> XL-002-R-2	<input type="radio"/> 277V	<input type="radio"/> 3000K	<input type="radio"/> 90+	<input type="radio"/> NON-Dimmable	<input type="radio"/> 24°	<input type="radio"/> Trimless	<input type="radio"/> White
<input type="radio"/> XL-002-R-3	<input type="radio"/> 120-277V	<input type="radio"/> 3500K			<input type="radio"/> 36°		<input type="radio"/> Brown
<input type="radio"/> XL-002-R-4		<input type="radio"/> 4000K			<input type="radio"/> 60°		
					<input type="radio"/> 90°		

* Other special requirements please confirm with our factory

LISTING / WARRANTY

ETL listed to US and Canadian standards for damp location W/Feed through. 5 Years Limited Warranty.



Liteharbor Harbor of Light!

PRESSABLE TRIMMED OR TRIMLESS MINIATURE MULTIPLE LED RECESSED DOWNLIGHT

LIGHT SOURCE COB LED XL-002-S Series



DESCRIPTION

This Product is the lighting embodiment of miniature, recessed LED solutions for residential and hospitality venues and boutiques. Available in a lot of shapes, frames, colors and accessories, as a straight or a symmetrical spot, or as general lighting, and it's combines choice with exclusive design and high-quality lighting technology.

FEATURES

The choice combines exclusive design with high quality lighting technology. A lot of shapes, frames and colors, providing more options for you. Available in 1,2, 3, 4 lamps. Beam Angle: 12/24/36/60/90 Degrees. Life Rated for 50,000 hours at 70% lumen maintenance. Easy installation.

APPLICATIONS

Suitable for jewelry stores, boutiques, luxury goods stores, shopping malls and other places that require concentrated lighting and accent lighting.

COVER COLOR OPTION



White Black Brown

* Customized is available

TRIM OPTION



Trimmed Trimless



XL-002-S-1-TL XL-002-S-2-TL XL-002-S-3-TL XL-002-S-4-TL

Beam Angle	2700k 4000k	80 90	AC 120V 277V 120-277V	6W	480lm 600lm
------------	----------------	----------	-----------------------------	----	----------------

DIMENSIONS

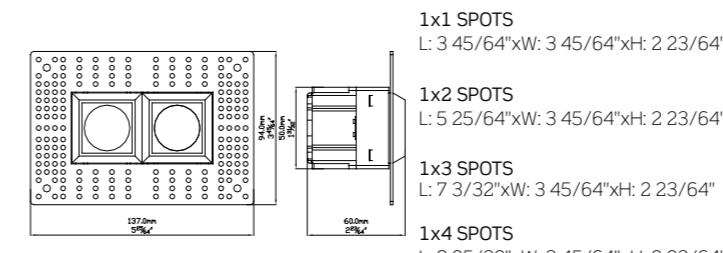

ORDERING GUIDE / YOUR PRODUCT CODE

SERIES/LUMEN	INPUT VOLTAGE	CCT	CRI	DIMMABLE	BEAM ANGLE	TRIM TYPE	FINISH
<input type="radio"/> XL-002-S-1	<input type="radio"/> AC 120V	<input type="radio"/> 2700K	<input type="radio"/> 80+	<input type="radio"/> Dimmable	<input type="radio"/> 12°	<input type="radio"/> Trimmed	<input type="radio"/> Black
<input type="radio"/> XL-002-S-2	<input type="radio"/> 277V	<input type="radio"/> 3000K	<input type="radio"/> 90+	<input type="radio"/> NON-Dimmable	<input type="radio"/> 24°	<input type="radio"/> Trimless	<input type="radio"/> White
<input type="radio"/> XL-002-S-3	<input type="radio"/> 120-277V	<input type="radio"/> 3500K			<input type="radio"/> 36°		<input type="radio"/> Brown
<input type="radio"/> XL-002-S-4		<input type="radio"/> 4000K			<input type="radio"/> 60°		
					<input type="radio"/> 90°		

* Other special requirements please confirm with our factory

LISTING / WARRANTY

ETL listed to US and Canadian standards for damp location W/Feed through. 5 Years Limited Warranty.



E-mail:info@liteharbor.com

PRESSABLE TRIMMED OR TRIMLESS MINIATURE LED RECESSED DOWNLIGHT

LIGHT SOURCE COB LED **XL-003-R Series**



DESCRIPTION

This Product is the lighting embodiment of miniature, recessed LED solutions for residential and hospitality venues and boutiques. Available in a lot of shapes, frames, colors and accessories, as a straight or a symmetrical spot, or as general lighting, and it's combines choice with exclusive design and high-quality lighting technology.

FEATURES

The choice combines exclusive design with high quality lighting technology. A lot of shapes, frames and colors, providing more options for you. Available in 1,2, 3, 4 lamps. Beam Angle: 12/24/36/60/90 Degrees. Life Rated for 50,000 hours at 70% lumen maintenance. Easy installation.

APPLICATIONS

Suitable for jewelry stores, boutiques, luxury goods stores, shopping malls and other places that require concentrated lighting and accent lighting.

COVER COLOR OPTION



White Black Brown

* Customized is available

TRIM OPTION



Trimmed Trimless



XL-003-R-1-TL XL-003-R-2-TL XL-003-R-3-TL XL-003-R-4-TL

Beam Angle	2700k 4000k	80 90	AC 120V 277 V 120-277 V	6 W	480 600 lm/W
Input Voltage	CCT	LED CRI	Power	Beam Angle	Lumen

DIMENSIONS

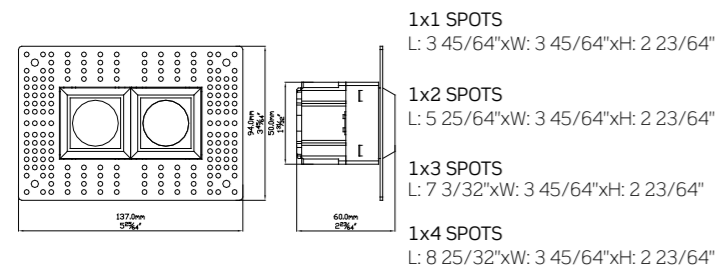

ORDERING GUIDE / YOUR PRODUCT CODE

SERIES/LUMEN	INPUT VOLTAGE	CCT	CRI	DIMMABLE	BEAM ANGLE	TRIM TYPE	FINISH
○ XL-003-R-1	○ AC 120V	○ 2700K	○ 80+	○ Dimmable	○ 12°	○ Trimmed	○ Black
○ XL-003-R-2	○ 277V	○ 3000K	○ 90+	○ NON-Dimmable	○ 24°	○ Trimless	○ White
○ XL-003-R-3	○ 120-277V	○ 3500K			○ 36°		○ Brown
○ XL-003-R-4		○ 4000K			○ 60°		
LED Downlight					○ 90°		

* Other special requirements please confirm with our factory

LISTING / WARRANTY

ETL listed to US and Canadian standards for damp location W/Feed through. 5 Years Limited Warranty.



Liteharbor Harbor of Light!

PRESSABLE TRIMMED OR TRIMLESS MINIATURE MULTIPLE LED RECESSED DOWNLIGHT

LIGHT SOURCE COB LED **XL-003-S Series**



DESCRIPTION

This Product is the lighting embodiment of miniature, recessed LED solutions for residential and hospitality venues and boutiques. Available in a lot of shapes, frames, colors and accessories, as a straight or a symmetrical spot, or as general lighting, and it's combines choice with exclusive design and high-quality lighting technology.

FEATURES

The choice combines exclusive design with high quality lighting technology. A lot of shapes, frames and colors, providing more options for you. Available in 1,2, 3, 4 lamps. Beam Angle: 12/24/36/60/90 Degrees. Life Rated for 50,000 hours at 70% lumen maintenance. Easy installation.

APPLICATIONS

Suitable for jewelry stores, boutiques, luxury goods stores, shopping malls and other places that require concentrated lighting and accent lighting.

COVER COLOR OPTION



White Black Brown

* Customized is available

TRIM OPTION



Trimmed Trimless



XL-003-S-1-TL XL-003-S-2-TL XL-003-S-3-TL XL-003-S-4-TL

Beam Angle	2700k 4000k	80 90	AC 120V 277 V 120-277 V	6 W	480 600 lm/W
Input Voltage	CCT	LED CRI	Power	Beam Angle	Lumen

DIMENSIONS

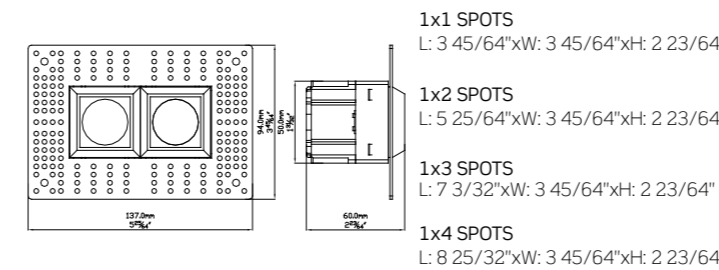

ORDERING GUIDE / YOUR PRODUCT CODE

SERIES/LUMEN	INPUT VOLTAGE	CCT	CRI	DIMMABLE	BEAM ANGLE	TRIM TYPE	FINISH
○ XL-003-S-1	○ AC 120V	○ 2700K	○ 80+	○ Dimmable	○ 12°	○ Trimmed	○ Black
○ XL-003-S-2	○ 277V	○ 3000K	○ 90+	○ NON-Dimmable	○ 24°	○ Trimless	○ White
○ XL-003-S-3	○ 120-277V	○ 3500K			○ 36°		○ Brown
○ XL-003-S-4		○ 4000K			○ 60°		
LED Downlight					○ 90°		

* Other special requirements please confirm with our factory

LISTING / WARRANTY

ETL listed to US and Canadian standards for damp location W/Feed through. 5 Years Limited Warranty.



E-mail:info@liteharbor.com

PRESSABLE TRIMMED OR TRIMLESS MINIATURE MULTIPLE LED RECESSED DOWNLIGHT

XL-004-R Series



DESCRIPTION

This Product is the lighting embodiment of miniature, recessed LED solutions for residential and hospitality venues and boutiques. Available in a lot of shapes, frames, colors and accessories, as a straight or a symmetrical spot, or as general lighting, and it's combines choice with exclusive design and high-quality lighting technology.

FEATURES

The choice combines exclusive design with high quality lighting technology. A lot of shapes, frames and colors, providing more options for you. Available in 1,2, 3, 4 lamps. Beam Angle: 12/24/36/60/90 Degrees. Life Rated for 50,000 hours at 70% lumen maintenance. Easy installation.

APPLICATIONS

Suitable for jewelry stores, boutiques, luxury goods stores, shopping malls and other places that require concentrated lighting and accent lighting.

COVER COLOR OPTION

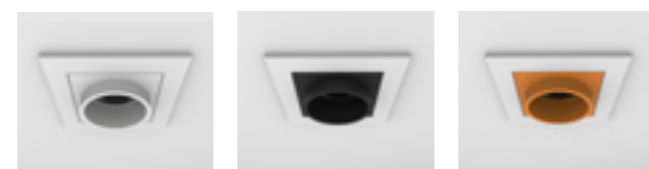

White Black Brown

* Customized is available

TRIM OPTION



Trimmed Trimless



XL-004-R-1-TL XL-004-R-2-TL XL-004-R-3-TL XL-004-R-4-TL

Beam Angle	2700k 4000k	80 90	AC 120V 277V 120-277V	6W	480 600 lm/W
	CCT	LED CRI	Input Voltage	Power	lm/W

DIMENSIONS

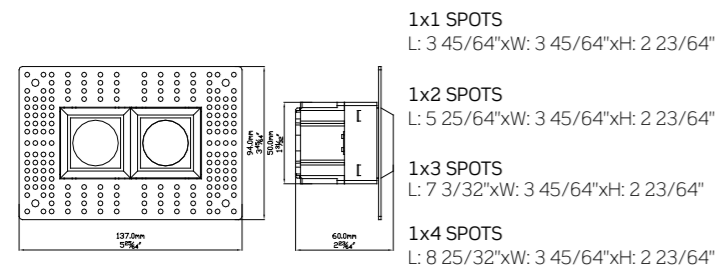

ORDERING GUIDE / YOUR PRODUCT CODE

SERIES/LUMEN	INPUT VOLTAGE	CCT	CRI	DIMMABLE	BEAM ANGLE	TRIM TYPE	FINISH
○ XL-004-R-1	○ AC 120V	○ 2700K	○ 80+	○ Dimmable	○ 12°	○ Trimmed	○ Black
○ XL-004-R-2	○ 277V	○ 3000K	○ 90+	○ NON-Dimmable	○ 24°	○ Trimless	○ White
○ XL-004-R-3	○ 120-277V	○ 3500K			○ 36°		○ Brown
○ XL-004-R-4		○ 4000K			○ 60°		
LED Downlight					○ 90°		

* Other special requirements please confirm with our factory

LISTING / WARRANTY

ETL listed to US and Canadian standards for damp location W/Feed through. 5 Years Limited Warranty.



Liteharbor Harbor of Light!

PRESSABLE TRIMMED OR TRIMLESS MINIATURE MULTIPLE LED RECESSED DOWNLIGHT

XL-004-S Series



DESCRIPTION

This Product is the lighting embodiment of miniature, recessed LED solutions for residential and hospitality venues and boutiques. Available in a lot of shapes, frames, colors and accessories, as a straight or a symmetrical spot, or as general lighting, and it's combines choice with exclusive design and high-quality lighting technology.

FEATURES

The choice combines exclusive design with high quality lighting technology. A lot of shapes, frames and colors, providing more options for you. Available in 1,2, 3, 4 lamps. Beam Angle: 12/24/36/60/90 Degrees. Life Rated for 50,000 hours at 70% lumen maintenance. Easy installation.

APPLICATIONS

Suitable for jewelry stores, boutiques, luxury goods stores, shopping malls and other places that require concentrated lighting and accent lighting.

COVER COLOR OPTION



White Black Brown

* Customized is available

TRIM OPTION



Trimmed Trimless



XL-004-S-1-TL XL-004-S-2-TL XL-004-S-3-TL XL-004-S-4-TL

Beam Angle	2700k 4000k	80 90	AC 120V 277V 120-277V	6W	480 600 lm/W
	CCT	LED CRI	Input Voltage	Power	lm/W

DIMENSIONS

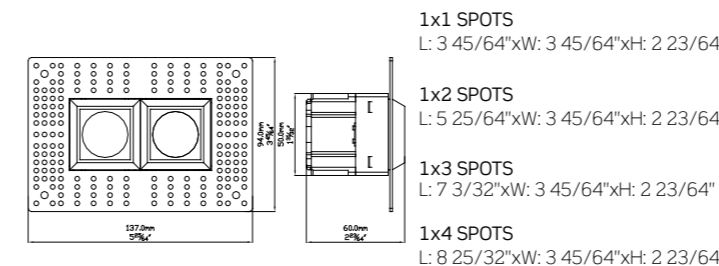

ORDERING GUIDE / YOUR PRODUCT CODE

SERIES/LUMEN	INPUT VOLTAGE	CCT	CRI	DIMMABLE	BEAM ANGLE	TRIM TYPE	FINISH
○ XL-004-S-1	○ AC 120V	○ 2700K	○ 80+	○ Dimmable	○ 12°	○ Trimmed	○ Black
○ XL-004-S-2	○ 277V	○ 3000K	○ 90+	○ NON-Dimmable	○ 24°	○ Trimless	○ White
○ XL-004-S-3	○ 120-277V	○ 3500K			○ 36°		○ Brown
○ XL-004-S-4		○ 4000K			○ 60°		
LED Downlight					○ 90°		

* Other special requirements please confirm with our factory

LISTING / WARRANTY

ETL listed to US and Canadian standards for damp location W/Feed through. 5 Years Limited Warranty.



E-mail:info@liteharbor.com

PRESSABLE TRIMLESS LINKABLE MINIATURE LED RECESSED DOWNLIGHTS SERIES



TRIMLESS LINKABLE LED RECESSED DOWNLIGHTS SERIES

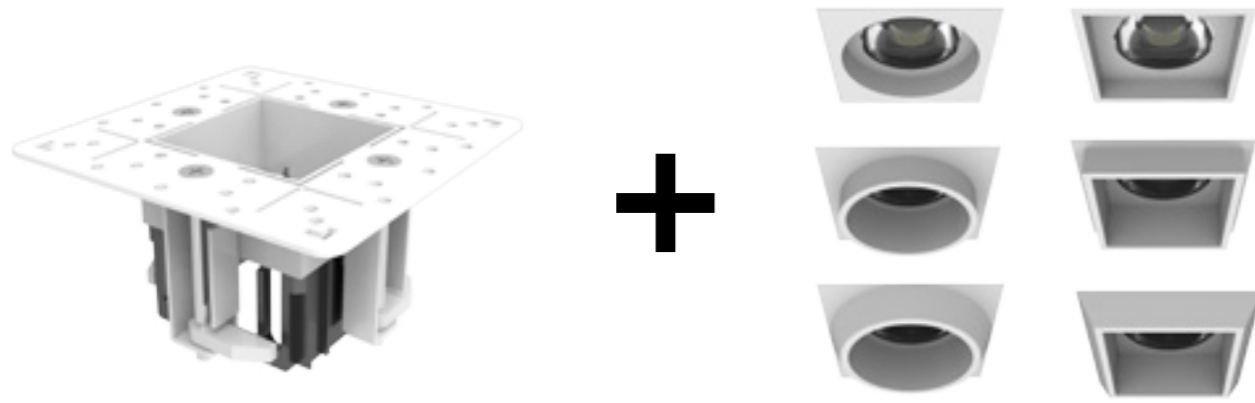

Voltage	AC 120V/277V/120-277V
Frequency	60 Hz
Watt	6W/Lamp
Lumen	480-600lm/Lamp
CRI	80+/90+
Beam Angle	12/24/36/60/90D
CCT	2700K-4000K
Material	Aluminum
Finish	White/Black/Brown

DESCRIPTION

This Product is the lighting embodiment of miniature, recessed LED solutions for residential and hospitality venues and boutiques. Available in a lot of shapes, frames, colors and accessories, as a straight or a symmetrical spot, or as general lighting, and it's combines choice with exclusive design and high-quality lighting technology.

FEATURES

The choice combines exclusive design with high quality lighting technology. A lot of shapes, frames and colors, providing more options for you. Available in 1, 2, 3, 4, 5, 6, 7, 8 lamps. Beam Angle: 12/24/36/60/90 Degrees. Life Rated for 50,000 hours at 70% lumen maintenance. Easy installation.

APPLICATIONS

Suitable for jewelry stores, boutiques, luxury goods stores, shopping malls and other places that require concentrated lighting and accent lighting.

DIMENSIONS

1 Lamp

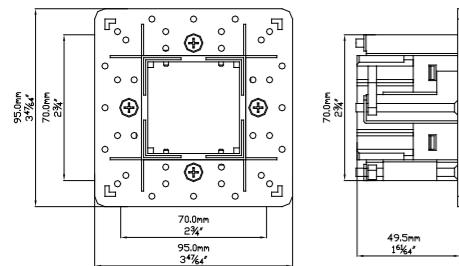

2 Lamps

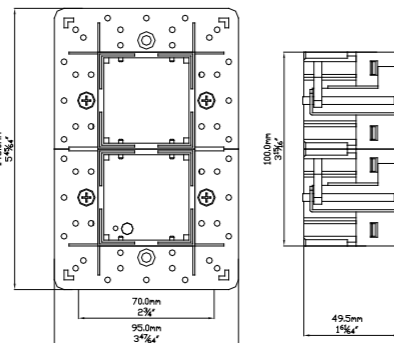

3 Lamps

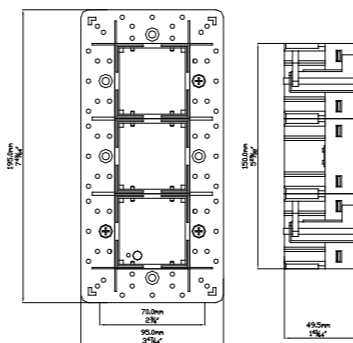

4 Lamps

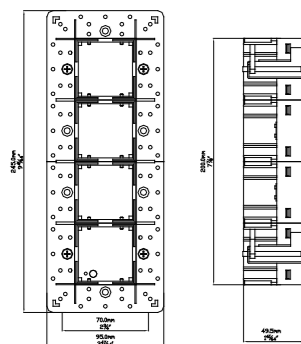

6 Lamps

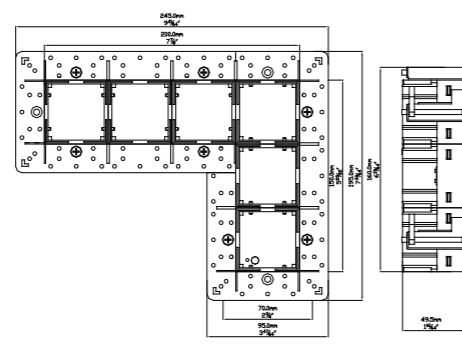

12°/24°/36°/60°/90° Beam Angle	2700k 4000k CCT	80 90 LED CRI
AC 120V 277V 120-277V Input Voltage	6W Power	480 600 lm/W Lumen

PRESSABLE TRIMLESS MINIATURE MULTIPLE LED RECESSED DOWNLIGHT

LED MODULE OPTIONS

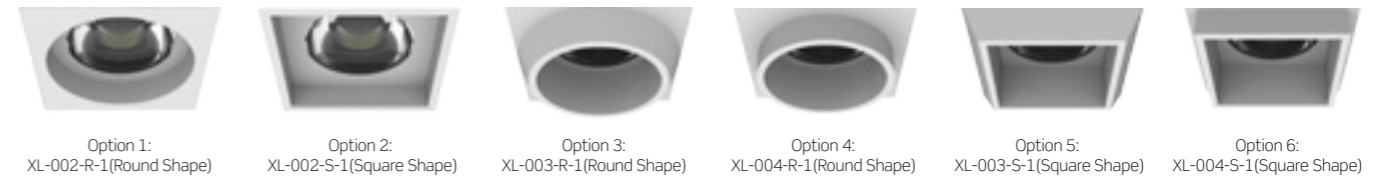

WHOLE LAMP EFFECT



COLOR OPTIONS



LAMPS OPTIONS



ORDERING GUIDE / YOUR PRODUCT CODE

SERIES	LAMP	INPUT VOLTAGE	CCT	CRI	DIMMABLE	FINISH	BEAM ANGLE
○ XL-002-R-LK	○ 1 Lamp	○ AC 120V	○ 2700K	○ 80+	○ Dimmable	○ Black	○ 12°
○ XL-002-S-LK	○ 2 Lamps	○ 277V	○ 3000K	○ 90+	○ NON-Dimmable	○ White	○ 24°
○ XL-003-R-LK	○ 3 Lamps	○ 120-277V	○ 3500K			○ Brown	○ 36°
○ XL-003-S-LK	○ 4 Lamps		○ 4000K				○ 60°
○ XL-004-R-LK	○ 5 Lamps(L-shaped)						○ 90°
○ XL-004-S-LK	○ 6 Lamps(L-shaped) ○ 7 Lamps(L-shaped) ○ 8 Lamps(L-shaped)						

* Other special requirements please confirm with our factory

LISTING / WARRANTY

ETL listed to US and Canadian standards for damp location W/Feed through. 5 Years Limited Warranty.

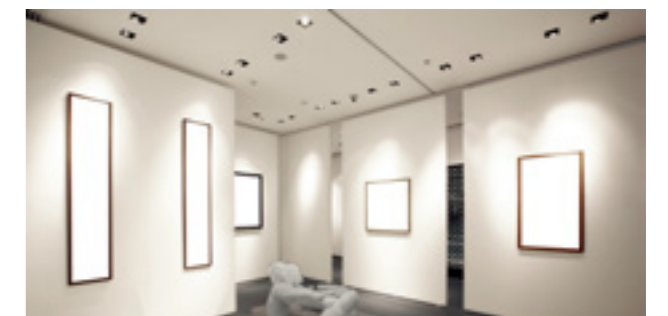

MINI LED MULTIPLE DOWNLIGHT

Liteharbor Mini LED Multiple Downlight provide a modern and aesthetically pleasing alternative to track or standard recessed installations. Available in a variety of light configurations, with both new construction and remodel options for installation. Whether in terms of design or usability, it is indeed one of the most versatile embedded products in the commercial lighting industry.



Anti-glare Linear Mini Multiple Lighting, Increase Your Visual Enjoyment

Commercial Mini Multiples

Liteharbor Mini Multiple Downlight Series is equipped with 1, 2, 5, 10, 15, 2x5, 2x10 and 2x15 lamps. The miniaturized design, die-cast aluminum body, and high-performance acrylic diffuser provide uniform scientific light output for maximum visual comfort make it affordable to any commercial applications.

Standard Configurations

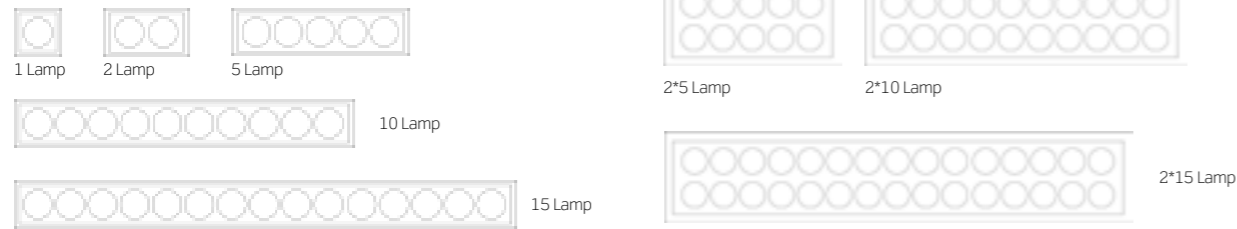

Why we choose mini LED multiple downlight?

- Modern and aesthetically pleasing alternative
- Economical reasonable lowest price
- Mini size to save place and reduce cost
- Vertical/Adjustable/Wall wash, three different beam angles for choose
- Available in 1, 2, 5, 10, 15, 2x5, 2x10 and 2x15 configurations
- Available in trim or trimless, providing more options for you

All Liteharbor Multiples are offered with 3-Year limited warranty. A robust sleek design, state-of-the-art engineering and a rigorous testing regimen are all factors that make our products so reliable. All the recessed multiples are cETLus listed. They can be well sold in North America market.



Lamp Body
High quality aluminum radiator

Light Source
High-efficiency lamp beads, a variety of color temperatures, high color rendering index

Reflector
Anti-glare

Concentrating Optical Reflector
Precise light distribution

Adjustable Fixing Frame
Fixed the lamp body



Cover And Reflector Color Options

* Multiple colors are optional and customized is available



Three Different Types of Lighting



Vertical Lighting

Architectural wonders and interesting spaces are highlighted and appreciated through the use of indoor vertical lighting. Vertical lighting emphasizes the limitations of space, making the area appear more spacious and open. Indoor vertical lighting increases our three-dimensional perception and gives environments depth.

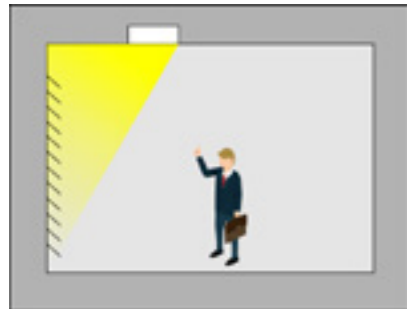

Wall Wash Lighting

For uniform vertical illuminance the distance a of the luminaire from the wall should be around one third of the room height. Optimal wall offset and luminaire spacing values are indicated in the wall washer tables on the product data sheets.

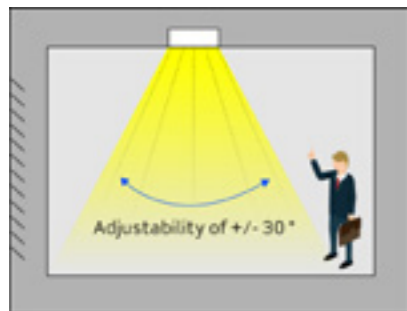

Adjustable Lighting

You can freely adjustable the irradiation angle according to the actual needs. It's a way of adding style and drama to your home or help you see when you're doing projects in which you need a finer light, this will help you illuminate the pieces you want on display. It will help you see more details and creating higher quality results.

Installation Options

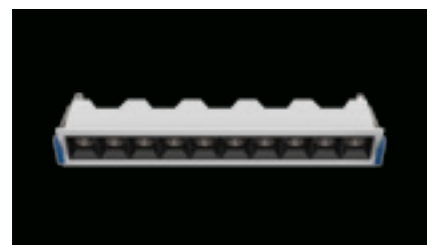

Remodel Installation

This is a simple and quick installation, push the spring retaining clips up and insert the lamp into the cut hole. Release the clips to finish the installation. It can be installed from below the ceiling in home remodel applications, ideal for those who have limited or no access to the ceiling.



New Construction with Housing

The New construction with housing is designed to be installed in the ceiling surrounded by insulation. And it is equipped with thermally protected. The housing won't overheat and cause a fire in the roof or overhead joist space. Airtight design keeps air conditioning or heating from leaking out of the home through the housing. Housing and Trim can be shipped separately.



New Construction with Mounting Plate

Plaster frame with hanger bar system to be installed during rough-in phase. To install a new construction lighting fixture you'll need to screw or nail the fixture's frame to the ceiling joists. For new construction ceiling assemblies, like Sheetrock, acoustic tiles, or paneling. Plaster frame and trim can be shipped separately.

Color Rendering Index(CRI)

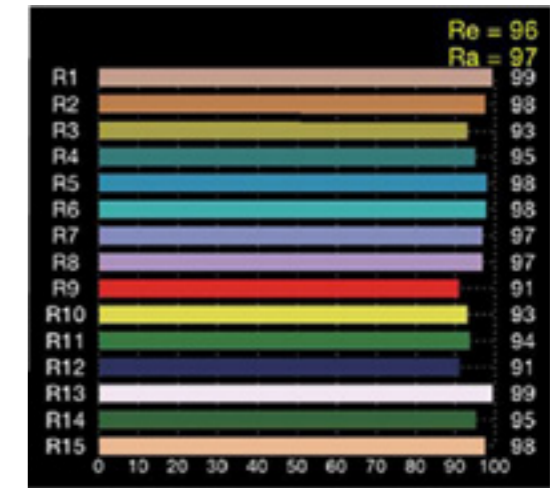
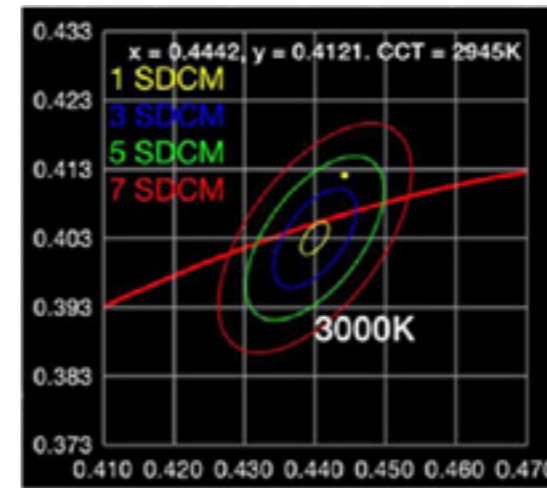

Color Rendering options comparison, 3000K

Liteharbor High Performance COB LED Track Lights Series is available in two CRI options, 80+ or 90+. The 90+ CRI option is only available in 2700K and 3000K. 90+ CRI delivers a premium high color rendering LED light source.

LIGHT DISTRIBUTION CURVE

10° 10W

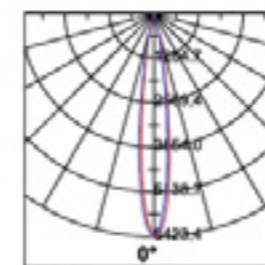

H(m)	E _{max}	D(m)
1m	6363Lx	0.24
2m	1590Lx	0.49
3m	707Lx	0.73
4m	398Lx	0.97
5m	255Lx	1.22

13.9°

15° 10W

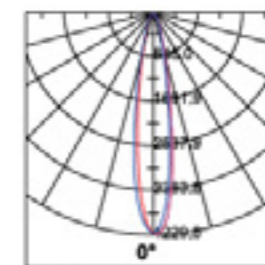

H(m)	E _{max}	D(m)
1m	4203Lx	0.31
2m	1050Lx	0.62
3m	467Lx	0.92
4m	263Lx	1.23
5m	168Lx	1.54

17.5°

30° 10W

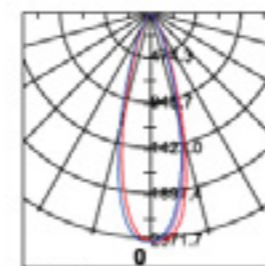

H(m)	E _{max}	D(m)
1m	2364Lx	5.40
2m	591Lx	1.08
3m	263Lx	1.61
4m	148Lx	2.16
5m	95Lx	2.70

30.2°

45° 10W

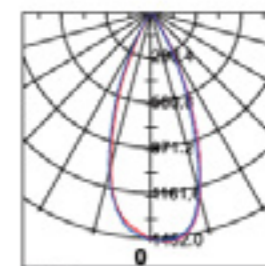

H(m)	E _{max}	D(m)
1m	1434Lx	7.53
2m	359Lx	1.51
3m	159Lx	2.26
4m	897Lx	3.02
5m	574Lx	3.77

41.3°



REMODEL VERTICAL MINI LED MULTIPLE DOWNLIGHT WITH 5 LAMPS

LIGHT SOURCE SMD CHIPS **G401XA-X Series**



DESCRIPTION

The Mini Multiple Downlight Series is equipped with 1, 2, 5, 10 and 15 lamps. The miniaturized design, die-cast aluminum body, and high-performance acrylic diffuser provide uniform scientific light output for maximum visual comfort.

FEATURES

Revolutionary narrow recessed downlight available in slim trim or trimless. The simplified retrofit installation can be used in both new and existing spaces. Dimmable with a variety of commonly used drivers. Life Rated for 50,000 hours at 70% lumen maintenance. Easy installation for new construction and remodel applications.

SPECIFICATION

Optics: Low luminance: Spot optic, with pptibeam technology
 Material: Body and Heat sink: Die-cast aluminum, Reflector and Baffle: Thermoplastic
 Mounting: New construction installation or remodel installation
 Electrical: High efficiency electronic driver, rated at 50 000 hours
 Weight: 0.1 to 2.42lbs (0.05 to 1.1kg)
 Warranty: 3 year limited warranty.

APPLICATIONS

Suitable for jewelry stores, boutiques, luxury goods stores, shopping malls and other places that require concentrated lighting and accent lighting.



TRIM OPTION



Trimmed



Trimless

DIMENSIONS

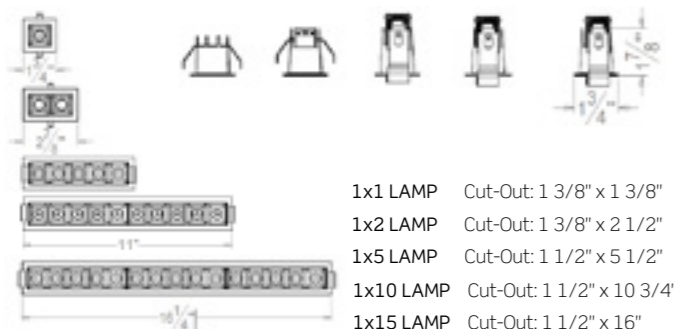

1x1 LAMP Cut-Out: 1 3/8" x 1 3/8"
 1x2 LAMP Cut-Out: 1 3/8" x 2 1/2"
 1x5 LAMP Cut-Out: 1 1/2" x 5 1/2"
 1x10 LAMP Cut-Out: 1 1/2" x 10 3/4"
 1x15 LAMP Cut-Out: 1 1/2" x 16"

ORDERING GUIDE / YOUR PRODUCT CODE

SERIES/LUMEN	INPUT VOLTAGE	CCT	CRI	DIMMING	TRIM	FINISH	REFLECTOR
<input type="radio"/> G4011A-01/150lm	<input type="radio"/> 120V	<input type="radio"/> 3000K	<input type="radio"/> 80+	<input type="radio"/> Non-dimming	<input type="radio"/> Trimmed	<input type="radio"/> White	<input type="radio"/> White
<input type="radio"/> G4011A-02/310lm	<input type="radio"/> 230V	<input type="radio"/> 4000K	<input type="radio"/> 90+	<input type="radio"/> TRIAC Dimming	<input type="radio"/> Trimless	<input type="radio"/> Black	<input type="radio"/> Black
<input type="radio"/> G4011A-05/720lm	<input type="radio"/> 277V	<input type="radio"/> 5000K		<input type="radio"/> 0~10V Dimming		<input type="radio"/> Silver	<input type="radio"/> Chrome
<input type="radio"/> G4012A-10/1450lm	<input type="radio"/> 120-277V						<input type="radio"/> Gold
<input type="radio"/> G4013A-15/2200lm							

* Other special requirements please confirm with our factory

LISTING / WARRANTY

ETL listed to US and Canadian standards for damp location W/Feed through. 3 Years Limited Warranty.

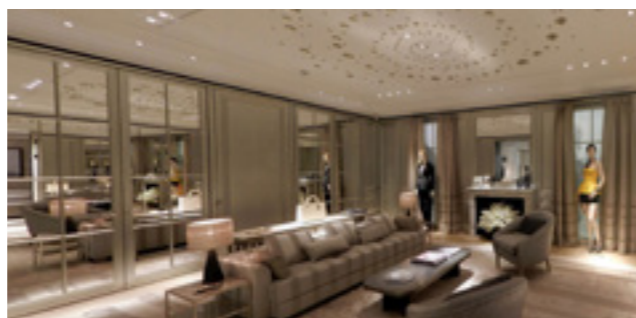

Liteharbor Harbor of Light!

IC AIRTIGHT NEW CONSTRUCTION VERTICAL MINI LED MULTIPLE DOWNLIGHT

LIGHT SOURCE SMD CHIPS **G401XA-X-IA Series**



DESCRIPTION

The IC Airtight New Construction Mini Multiple Downlight Series is equipped with 1, 2, 5, 10 and 15 lamps. The miniaturized design, die-cast aluminum body, and high-performance acrylic diffuser provide uniform scientific light output for maximum visual comfort.

FEATURES

Revolutionary narrow recessed downlight available in slim trim or trimless. The simplified retrofit installation can be used in both new and existing spaces. Dimmable with a variety of commonly used drivers. Life Rated for 50,000 hours at 70% lumen maintenance. Easy installation for new construction and remodel applications.

SPECIFICATION

Optics: Low luminance: Spot optic, with pptibeam technology
 Material: Body and Heat sink: Die-cast aluminum, Reflector and Baffle: Thermoplastic
 Mounting: New construction installation or remodel installation
 Electrical: High efficiency electronic driver, rated at 50 000 hours
 Weight: 0.1 to 2.42lbs (0.05 to 1.1kg)
 Warranty: 3 year limited warranty.

APPLICATIONS

Suitable for jewelry stores, boutiques, luxury goods stores, shopping malls and other places that require concentrated lighting and accent lighting.

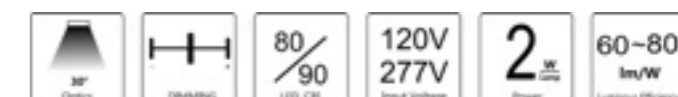

TRIM OPTION



Trimmed



Trimless

DIMENSIONS

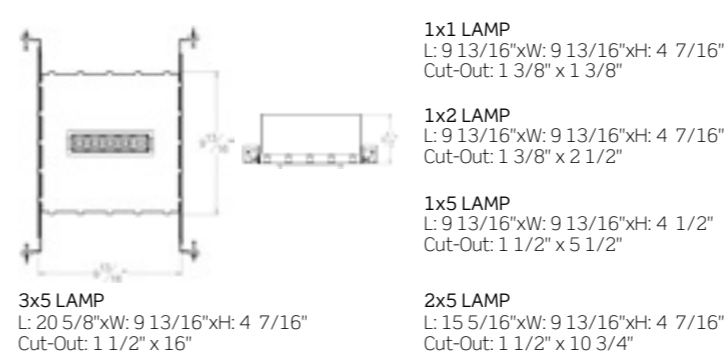

1x1 LAMP
 L: 9 13/16"xW: 9 13/16"xH: 4 7/16"
 Cut-Out: 1 3/8" x 1 3/8"
 1x2 LAMP
 L: 9 13/16"xW: 9 13/16"xH: 4 7/16"
 Cut-Out: 1 3/8" x 2 1/2"
 1x5 LAMP
 L: 9 13/16"xW: 9 13/16"xH: 4 1/2"
 Cut-Out: 1 1/2" x 5 1/2"
 3x5 LAMP
 L: 20 5/8"xW: 9 13/16"xH: 4 7/16"
 Cut-Out: 1 1/2" x 16"
 2x5 LAMP
 L: 15 5/16"xW: 9 13/16"xH: 4 7/16"
 Cut-Out: 1 1/2" x 10 3/4"

ORDERING GUIDE / YOUR PRODUCT CODE

SERIES/LUMEN	INPUT VOLTAGE	CCT	CRI	DIMMING	TRIM	FINISH	REFLECTOR
<input type="radio"/> G4011A-01-IA/150lm	<input type="radio"/> 120V	<input type="radio"/> 3000K	<input type="radio"/> 80+	<input type="radio"/> Non-dimming	<input type="radio"/> Trimmed	<input type="radio"/> White	<input type="radio"/> White
<input type="radio"/> G4011A-02-IA/310lm	<input type="radio"/> 230V	<input type="radio"/> 4000K	<input type="radio"/> 90+	<input type="radio"/> TRIAC Dimming	<input type="radio"/> Trimless	<input type="radio"/> Black	<input type="radio"/> Black
<input type="radio"/> G4011A-05-IA/720lm	<input type="radio"/> 277V	<input type="radio"/> 5000K		<input type="radio"/> 0~10V Dimming		<input type="radio"/> Silver	<input type="radio"/> Chrome
<input type="radio"/> G4012A-10-IA/1450lm	<input type="radio"/> 120-277V						<input type="radio"/> Gold
<input type="radio"/> G4013A-15-IA/2200lm							

* Other special requirements please confirm with our factory

LISTING / WARRANTY

ETL listed to US and Canadian standards for damp location W/Feed through. 3 Years Limited Warranty.



E-mail:info@liteharbor.com

NEW CONSTRUCTION VERTICAL MINI LED MULTIPLE DOWNLIGHT

LIGHT SOURCE SMD CHIPS G401XA-X-NC Series



G4011A-01-NC G4011A-02-NC G4013A-05-NC

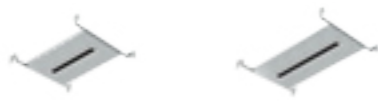

G4012A-10-NC G4013A-15-NC

DESCRIPTION

The New Construction Mini Multiple Downlight are equipped with 1, 2, 5, 10 and 15 lamps. The miniaturized design, die-cast aluminum body, and high-performance acrylic diffuser provide uniform scientific light output for maximum visual comfort.

FEATURES

Revolutionary narrow recessed downlight available in slim trim or trimless. The simplified retrofit installation can be used in both new and existing spaces. Dimmable with a variety of commonly used drivers. Life Rated for 50,000 hours at 70% lumen maintenance. Easy installation for new construction and remodel applications.

SPECIFICATION

Optics: Low luminance: Spot optic, with pptibeam technology
Material: Body and Heat sink: Die-cast aluminum, Reflector and Baffle: Thermoplastic
Mounting: New construction installation or remodel installation
Electrical: High efficiency electronic driver, rated at 50 000 hours
Weight: 0.1 to 2.42lbs (0.05 to 1.1kg)
Warranty: 3 year limited warranty.

APPLICATIONS

Suitable for jewelry stores, boutiques, luxury goods stores, shopping malls and other places that require concentrated lighting and accent lighting.

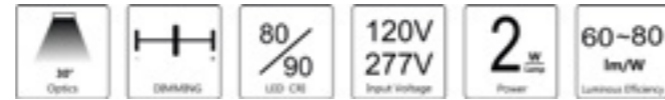

TRIM OPTION



Trimmed

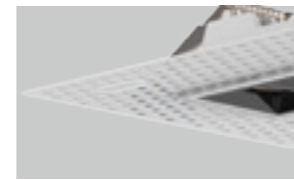

Trimless

DIMENSIONS

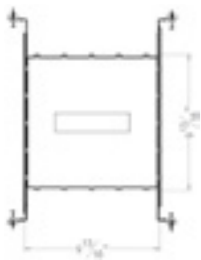

1x1 LAMP
L: 9 13/16"xW: 9 13/16"
Cut-Out: 1 3/8" x 1 3/8"

1x2 LAMP
L: 9 13/16"xW: 9 13/16"
Cut-Out: 1 3/8" x 2 1/2"

1x5 LAMP
L: 9 13/16"xW: 9 13/16"
Cut-Out: 1 1/2" x 5 1/2"

3x5 LAMP
L: 20 5/8"xW: 9 13/16"
Cut-Out: 1 1/2" x 16"

2x5 LAMP
L: 15 5/16"xW: 9 13/16"
Cut-Out: 1 1/2" x 10 3/4"

ORDERING GUIDE / YOUR PRODUCT CODE

SERIES/LUMEN	INPUT VOLTAGE	CCT	CRI	DIMMING	TRIM	FINISH	REFLECTOR
<input type="radio"/> G4011A-01-NC/150lm	<input type="radio"/> 120V	<input type="radio"/> 3000K	<input type="radio"/> 80+	<input type="radio"/> Non-dimming	<input type="radio"/> Trimmed	<input type="radio"/> White	<input type="radio"/> White
<input type="radio"/> G4011A-02-NC/310lm	<input type="radio"/> 230V	<input type="radio"/> 4000K	<input type="radio"/> 90+	<input type="radio"/> TRIAC Dimming	<input type="radio"/> Trimless	<input type="radio"/> Black	<input type="radio"/> Black
<input type="radio"/> G4011A-05-NC/720lm	<input type="radio"/> 277V	<input type="radio"/> 5000K		<input type="radio"/> 0~10V Dimming		<input type="radio"/> Silver	<input type="radio"/> Chrome
<input type="radio"/> G4012A-10-NC/1450lm	<input type="radio"/> 120-277V						<input type="radio"/> Gold
<input type="radio"/> G4013A-15-NC/2200lm							

* Other special requirements please confirm with our factory

LISTING / WARRANTY

ETL listed to US and Canadian standards for damp location W/Feed through. 3 Years Limited Warranty.

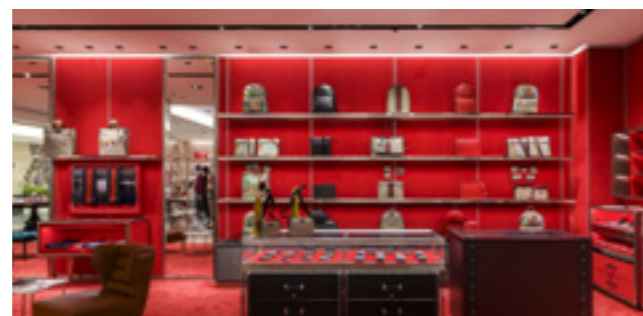

Liteharbor Harbor of Light!

REMODEL ADJUSTABLE MINI LED MULTIPLE DOWNLIGHT

LIGHT SOURCE SMD CHIPS G401XA-X-A Series



G4011A-2x05-A G4011A-05-A G4012A-10-A



G4012A-2x10-A G4013A-15-A G4013A-2x15-A

DESCRIPTION

The Mini Multiple Downlight Series is equipped with 5, 10 and 15, 5x2, 10x2, 15x2 lamps. The miniaturized design, die-cast aluminum body, and high-performance acrylic diffuser provide uniform scientific light output for maximum visual comfort. Recessed rectangular luminaire with LEDs. Shaped steel sheet structural compartment with outer rim. The 15 lighting cells linear body, in die-cast aluminum, can be used to direct the emission with a tilting adjustability of +/- 30°.

FEATURES

The simplified retrofit installation can be used in both new and existing spaces.

SPECIFICATION

Optics: Low luminance: Spot optic, with pptibeam technology
Material: Body and Heat sink: Die-cast aluminum, Reflector and Baffle: Thermoplastic
Mounting: New construction installation or remodel installation
Electrical: High efficiency electronic driver, rated at 50 000 hours
Weight: 0.1 to 2.42lbs (0.05 to 1.1kg)
Warranty: 3 year limited warranty.

APPLICATIONS

Suitable for jewelry stores, boutiques, luxury goods stores, shopping malls and other places that require concentrated lighting and accent lighting.



DIMENSIONS

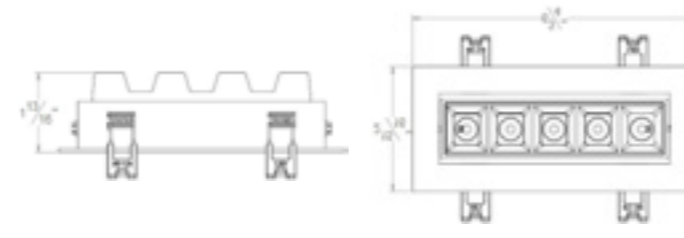

1x5 LAMP
L: 6 3/4"xW: 2 15/16"xH: 1 13/16"
Cut-Out: 2 1/4" x 6 1/16"

2x5 LAMP
L: 7 5/16"xW: 6 5/16"xH: 4"
Cut-Out: 5 7/16" x 5 1/2"

1x10 LAMP
L: 11 7/8"xW: 2 15/16"xH: 1 7/8"
Cut-Out: 2 1/4" x 11 5/16"

2x10 LAMP
L: 12 5/8"xW: 6 5/16"xH: 4"
Cut-Out: 5 7/16" x 11 5/8"

1x15 LAMP
L: 17 1/8"xW: 2 15/16"xH: 1 7/8"
Cut-Out: 2 1/4" x 16 1/2"

2x15 LAMP
L: 17 13/16"xW: 6 5/16"xH: 4"
Cut-Out: 5 7/16" x 16 1/2"

ORDERING GUIDE / YOUR PRODUCT CODE

SERIES/LUMEN	INPUT VOLTAGE	CCT	CRI	DIMMING	TRIM	FINISH	REFLECTOR
<input type="radio"/> G4011A-05-A/720lm	<input type="radio"/> 120V	<input type="radio"/> 3000K	<input type="radio"/> 80+	<input type="radio"/> Non-dimming	<input type="radio"/> Trimmed	<input type="radio"/> White	<input type="radio"/> White
<input type="radio"/> G4011A-2x05-A/1450lm	<input type="radio"/> 230V	<input type="radio"/> 4000K	<input type="radio"/> 90+	<input type="radio"/> TRIAC Dimming	<input type="radio"/> Trimless	<input type="radio"/> Black	<input type="radio"/> Black
<input type="radio"/> G4012A-10-A/1450lm	<input type="radio"/> 277V	<input type="radio"/> 5000K		<input type="radio"/> 0~10V Dimming		<input type="radio"/> Silver	<input type="radio"/> Chrome
<input type="radio"/> G4012A-2x10-A/2900lm	<input type="radio"/> 120-277V						<input type="radio"/> Gold
<input type="radio"/> G4013A-15-A/2200lm							
<input type="radio"/> G4013A-2x15-A/4400lm							

* Other special requirements please confirm with our factory

LISTING / WARRANTY

ETL listed to US and Canadian standards for damp location W/Feed through. 3 Years Limited Warranty.



E-mail: info@liteharbor.com

IC AIRTIGHT NEW CONSTRUCTION ADJUSTABLE MINI LED MULTIPLE DOWNLIGHT

LIGHT SOURCE SMD CHIPS **G401XA-X-A-IA Series**

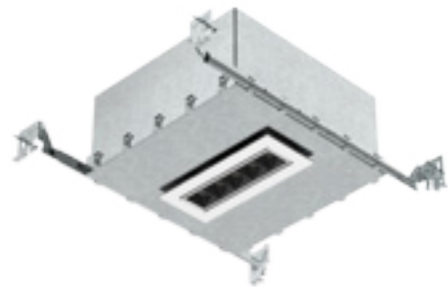

DESCRIPTION

The Mini Multiple Downlight Series is equipped with 5, 10 and 15, 5x2, 10x2, 15x2 lamps. The miniaturized design, die-cast aluminum body, and high-performance acrylic diffuser provide uniform scientific light output for maximum visual comfort. Recessed rectangular luminaire with LEDs. Shaped steel sheet structural compartment with outer rim. The N*5 lighting cells linear body, in die-cast aluminium, can be used to direct the emission with a tilting adjustability of +/- 30°.

FEATURES

The simplified retrofit installation can be used in both new and existing spaces. Dimmable with a variety of commonly used drivers. Life Rated for 50,000 hours at 70% lumen maintenance. Easy installation for new construction and remodel applications.

SPECIFICATION

Optics: Low luminance: Spot optic, with pptbeam technology
 Material: Body and Heat sink: Die-cast aluminum, Reflector and Baffle: Thermoplastic
 Mounting: New construction installation or remodel installation
 Electrical: High efficiency electronic driver, rated at 50 000 hours
 Weight: 0.1 to 2.42lbs (0.05 to 1.1kg)
 Warranty: 3 year limited warranty.

APPLICATIONS

Suitable for jewelry stores, boutiques, luxury goods stores, shopping malls and other places that require concentrated lighting and accent lighting.

DIMENSIONS

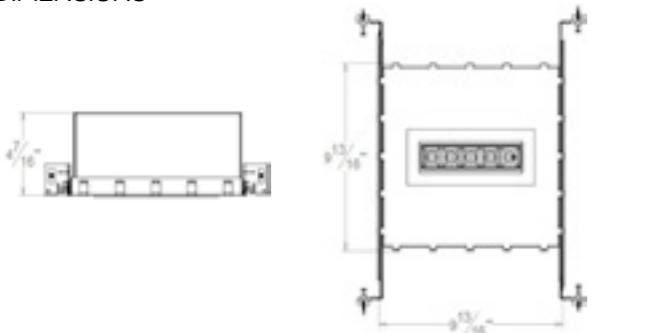

1x5 LAMP
 L: 9 13/16"xW: 9 13/16"xH: 4 7/16"
 Cut-Out: 2 1/4" x 6 1/16"

1x10 LAMP
 L: 15 5/16"xW: 9 13/16"xH: 4 7/16"
 Cut-Out: 2 1/4" x 11 5/16"

1x15 LAMP
 L: 20 5/8"xW: 9 13/16"xH: 4 7/16"
 Cut-Out: 2 1/4" x 16 1/2"

ORDERING GUIDE / YOUR PRODUCT CODE

SERIES/LUMEN	INPUT VOLTAGE	CCT	CRI	DIMMING	TRIM	FINISH	REFLECTOR
<input type="radio"/> G4011A-01-IA/150lm	<input type="radio"/> 120V	<input type="radio"/> 3000K	<input type="radio"/> 80+	<input type="radio"/> Non-dimming	<input type="radio"/> Trimmed	<input type="radio"/> White	<input type="radio"/> White
<input type="radio"/> G4011A-02-IA/310lm	<input type="radio"/> 230V	<input type="radio"/> 4000K	<input type="radio"/> 90+	<input type="radio"/> TRIAC Dimming	<input type="radio"/> Trimless	<input type="radio"/> Black	<input type="radio"/> Black
<input type="radio"/> G4011A-05-A-IA/720lm	<input type="radio"/> 277V	<input type="radio"/> 5000K		<input type="radio"/> 0~10V Dimming		<input type="radio"/> Silver	<input type="radio"/> Chrome
<input type="radio"/> G4012A-10-A-IA/1450lm	<input type="radio"/> 120-277V						<input type="radio"/> Gold
<input type="radio"/> G4013A-15-A-IA/2200lm							

* Other special requirements please confirm with our factory

LISTING / WARRANTY

ETL listed to US and Canadian standards for damp location W/Feed through. 3 Years Limited Warranty.



Liteharbor Harbor of Light!

NEW CONSTRUCTION ADJUSTABLE MINI LED MULTIPLE DOWNLIGHT

LIGHT SOURCE SMD CHIPS **G401XA-X-A-NC Series**

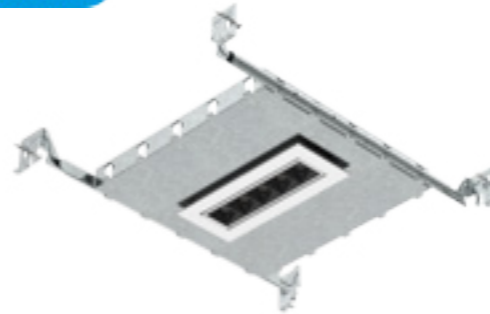

DIMENSIONS

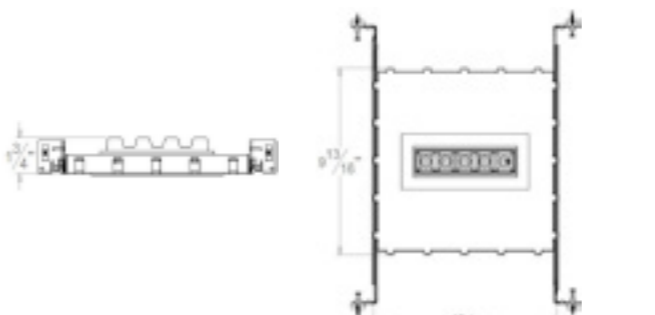

DESCRIPTION

The Mini Multiple Downlight Series is equipped with 5, 10 and 15, 5x2, 10x2, 15x2 lamps. The miniaturized design, die-cast aluminum body, and high-performance acrylic diffuser provide uniform scientific light output for maximum visual comfort. Recessed rectangular luminaire with LEDs. Shaped steel sheet structural compartment with outer rim. The N*5 lighting cells linear body, in die-cast aluminium, can be used to direct the emission with a tilting adjustability of +/- 30°.

FEATURES

The simplified retrofit installation can be used in both new and existing spaces.

SPECIFICATION

Optics: Low luminance: Spot optic, with pptbeam technology
 Material: Body and Heat sink: Die-cast aluminum, Reflector and Baffle: Thermoplastic
 Mounting: New construction installation or remodel installation
 Electrical: High efficiency electronic driver, rated at 50 000 hours
 Weight: 0.1 to 2.42lbs (0.05 to 1.1kg)
 Warranty: 3 year limited warranty.

APPLICATIONS

Suitable for jewelry stores, boutiques, luxury goods stores, shopping malls and other places that require concentrated lighting and accent lighting.

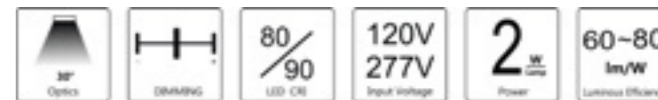

1x5 LAMP
 L: 9 13/16"xW: 9 13/16"xH: 1 3/4"
 Cut-Out: 2 1/4" x 6 1/16"

2x5 LAMP
 L: 9 13/16"xW: 9 13/16"xH: 3 7/8"
 Cut-Out: 5 7/16" x 5 1/2"

1x10 LAMP
 L: 9 13/16"xW: 15 5/16"xH: 1 9/16"
 Cut-Out: 2 1/4" x 11 5/16"

2x10 LAMP
 L: 15 5/16"xW: 9 13/16"xH: 3 7/8"
 Cut-Out: 5 7/16" x 11 5/8"

1x15 LAMP
 L: 20 5/8"xW: 9 13/16"xH: 1 9/16"
 Cut-Out: 2 1/4" x 16 1/2"

2x15 LAMP
 L: 20 9/16"xW: 9 13/16"xH: 3 7/8"
 Cut-Out: 5 7/16" x 16 1/2"

ORDERING GUIDE / YOUR PRODUCT CODE

SERIES/LUMEN	INPUT VOLTAGE	CCT	CRI	DIMMING	TRIM	FINISH	REFLECTOR
<input type="radio"/> G4011A-05-A-NC/720lm	<input type="radio"/> 120V	<input type="radio"/> 3000K	<input type="radio"/> 80+	<input type="radio"/> Non-dimming	<input type="radio"/> Trimmed	<input type="radio"/> White	<input type="radio"/> White
<input type="radio"/> G4011A-2x05-A-NC/1450lm	<input type="radio"/> 230V	<input type="radio"/> 4000K	<input type="radio"/> 90+	<input type="radio"/> TRIAC Dimming	<input type="radio"/> Trimless	<input type="radio"/> Black	<input type="radio"/> Black
<input type="radio"/> G4012A-10-A-NC/1450lm	<input type="radio"/> 277V	<input type="radio"/> 5000K		<input type="radio"/> 0~10V Dimming		<input type="radio"/> Silver	<input type="radio"/> Chrome
<input type="radio"/> G4012A-2x10-A-NC/2900lm	<input type="radio"/> 120-277V						<input type="radio"/> Gold
<input type="radio"/> G4013A-15-A-NC/1450lm							
<input type="radio"/> G4013A-2x15-A-NC/4400lm							

* Other special requirements please confirm with our factory

LISTING / WARRANTY

ETL listed to US and Canadian standards for damp location W/Feed through. 3 Years Limited Warranty.



E-mail:info@liteharbor.com

REMODEL WALL WASH MINI LED MULTIPLE DOWNLIGHT

LIGHT SOURCE SMD CHIPS **G401XA-X-W Series**



DESCRIPTION

The Mini Multiple Downlight Series is equipped with 5, 10 and 15 lamps. The miniaturized design, die-cast aluminum body, and high-performance acrylic diffuser provide uniform scientific light output for maximum visual comfort. It can illuminate the whole wall without any shadow. Miniaturized recessed rectangular luminaire with LEDs. Main body with die-cast aluminium radiant surface, version with perimeter surface frame. Asymmetrical optic system designed to achieve an effective wall washer distribution.

FEATURES

Revolutionary narrow recessed downlight available in slim trim or trimless. The simplified retrofit installation can be used in both new and existing spaces. Life Rated for 50,000 hours at 70% lumen maintenance. Easy installation for new construction and remodel applications.

SPECIFICATION

Optics: Low luminance: Spot optic, with pptbeam technology
 Material: Body and Heat sink: Die-cast aluminum, Reflector and Baffle: Thermoplastic
 Mounting: New construction installation or remodel installation
 Electrical: High efficiency electronic driver, rated at 50 000 hours
 Weight: 0.1 to 2.42lbs (0.05 to 1.1kg)
 Warranty: 3 year limited warranty.

APPLICATIONS

Suitable for jewelry stores, boutiques, luxury goods stores, shopping malls and other places that require concentrated lighting and accent lighting.

TRIM OPTION



Trimmed



Trimless

- ▶ G4011A-05-W
- ▶ G4012A-10-W
- ▶ G4013A-15-W



DIMENSIONS

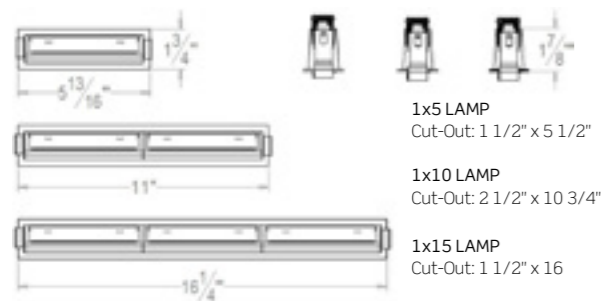

ORDERING GUIDE / YOUR PRODUCT CODE

SERIES/LUMEN	INPUT VOLTAGE	CCT	CRI	DIMMING	TRIM	FINISH	REFLECTOR
<input type="radio"/> G4011A-05-W/650lm	<input type="radio"/> 120V	<input type="radio"/> 3000K	<input type="radio"/> 80+	<input type="radio"/> Non-dimming	<input type="radio"/> Trimmed	<input type="radio"/> White	<input type="radio"/> White
<input type="radio"/> G4012A-10-W/1300lm	<input type="radio"/> 230V	<input type="radio"/> 4000K	<input type="radio"/> 90+	<input type="radio"/> TRIAC Dimming	<input type="radio"/> Trimless	<input type="radio"/> Black	<input type="radio"/> Black
<input type="radio"/> G4013A-15-W/1950lm	<input type="radio"/> 277V	<input type="radio"/> 5000K		<input type="radio"/> 0~10V Dimming		<input type="radio"/> Silver	<input type="radio"/> Chrome
	<input type="radio"/> 120-277V						<input type="radio"/> Gold

* Other special requirements please confirm with our factory

LISTING / WARRANTY

ETL listed to US and Canadian standards for damp location W/Feed through. 3 Years Limited Warranty.

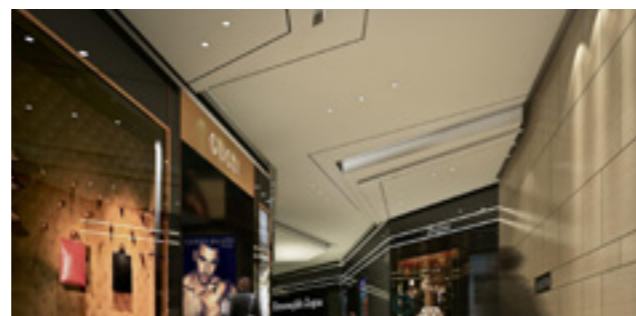

Liteharbor Harbor of Light!

NEW CONSTRUCTION IC AIRTIGHT WALL WASH MINI LED MULTIPLE

LIGHT SOURCE SMD CHIPS **G401XA-X-W-IA Series**

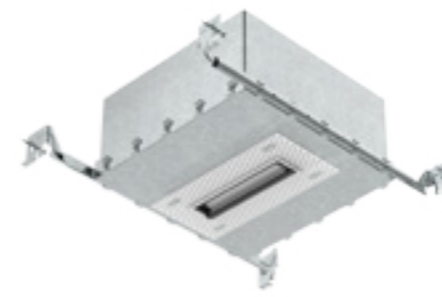

DESCRIPTION

The Mini Multiple Downlight Series is equipped with 5, 10 and 15 lamps. The miniaturized design, die-cast aluminum body, and high-performance acrylic diffuser provide uniform scientific light output for maximum visual comfort. It can illuminate the whole wall without any shadow. Miniaturized recessed rectangular luminaire with LEDs. Main body with die-cast aluminium radiant surface, version with perimeter surface frame. Asymmetrical optic system designed to achieve an effective wall washer distribution.

FEATURES

Revolutionary narrow recessed downlight available in slim trim or trimless. The simplified retrofit installation can be used in both new and existing spaces. Life Rated for 50,000 hours at 70% lumen maintenance. Easy installation for new construction and remodel applications.

SPECIFICATION

Optics: Low luminance: Spot optic, with pptbeam technology
 Material: Body and Heat sink: Die-cast aluminum, Reflector and Baffle: Thermoplastic
 Mounting: New construction installation or remodel installation
 Electrical: High efficiency electronic driver, rated at 50 000 hours
 Weight: 0.1 to 2.42lbs (0.05 to 1.1kg)
 Warranty: 3 year limited warranty.

APPLICATIONS

Suitable for jewelry stores, boutiques, luxury goods stores, shopping malls and other places that require concentrated lighting and accent lighting.

TRIM OPTION



Trimmed

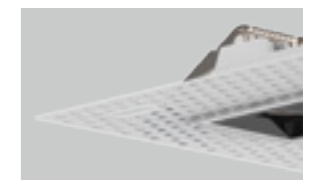

Trimless

- ▶ G4011A-05-W-IA
- ▶ G4012A-10-W-IA
- ▶ G4013A-15-W-IA



DIMENSIONS

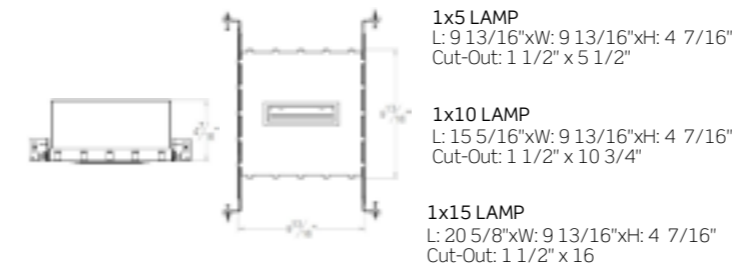

ORDERING GUIDE / YOUR PRODUCT CODE

SERIES/LUMEN	INPUT VOLTAGE	CCT	CRI	DIMMING	TRIM	FINISH	REFLECTOR
<input type="radio"/> G4011A-05-W-IA/650lm	<input type="radio"/> 120V	<input type="radio"/> 3000K	<input type="radio"/> 80+	<input type="radio"/> Non-dimming	<input type="radio"/> Trimmed	<input type="radio"/> White	<input type="radio"/> White
<input type="radio"/> G4012A-10-W-IA/1300lm	<input type="radio"/> 230V	<input type="radio"/> 4000K	<input type="radio"/> 90+	<input type="radio"/> TRIAC Dimming	<input type="radio"/> Trimless	<input type="radio"/> Black	<input type="radio"/> Black
<input type="radio"/> G4013A-15-W-IA/1950lm	<input type="radio"/> 277V	<input type="radio"/> 5000K		<input type="radio"/> 0~10V Dimming		<input type="radio"/> Silver	<input type="radio"/> Chrome
	<input type="radio"/> 120-277V						<input type="radio"/> Gold

* Other special requirements please confirm with our factory

LISTING / WARRANTY

ETL listed to US and Canadian standards for damp location W/Feed through. 3 Years Limited Warranty.

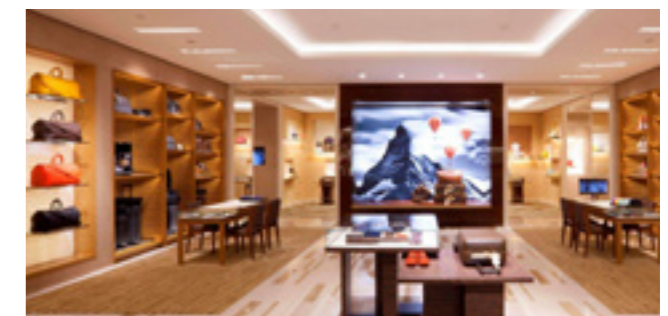

E-mail: info@liteharbor.com

NEW CONSTRUCTION WALL WASH MINI LED MULTIPLE DOWNLIGHT



G401XA-X-W-NC Series



G4011A-05-W-NC



G4012A-10-W-NC



G4013A-15-W-NC



DESCRIPTION

The Mini Multiple Downlight Series is equipped with 5, 10 and 15 lamps. The miniaturized design, die-cast aluminum body, and high-performance acrylic diffuser provide uniform scientific light output for maximum visual comfort. It can illuminate the whole wall without any shadow. Miniaturized recessed rectangular luminaire with LEDs. Main body with die-cast aluminium radiant surface, version with perimeter surface frame. Asymmetrical optic system designed to achieve an effective wall washer distribution.

FEATURES

Revolutionary narrow recessed downlight available in slim trim or trimless. The simplified retrofit installation can be used in both new and existing spaces. Life Rated for 50,000 hours at 70% lumen maintenance. Easy installation for new construction and remodel applications.

SPECIFICATION

Optics: Low luminance: Spot optic, with pptbeam technology
 Material: Body and Heat sink: Die-cast aluminum, Reflector and Baffle: Thermoplastic
 Mounting: New construction installation or remodel installation
 Electrical: High efficiency electronic driver, rated at 50 000 hours
 Weight: 0.1 to 2.42lbs (0.05 to 1.1kg)
 Warranty: 3 year limited warranty.

APPLICATIONS

Suitable for jewelry stores, boutiques, luxury goods stores, shopping malls and other places that require concentrated lighting and accent lighting.

DIMENSIONS

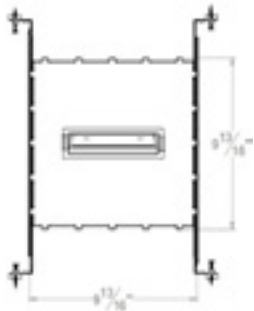

1x5 LAMP
 L: 9 13/16"xW: 9 13/16"
 Cut-Out: 1 1/2" x 5 1/2"

1x10 LAMP
 L: 15 1/4"xW: 9 13/16"
 Cut-Out: 1 1/2" x 10 3/4"

1x15 LAMP
 L: 20 5/8"xW: 9 13/16"
 Cut-Out: 1 1/2" x 16"

TRIM OPTION



Trimmed

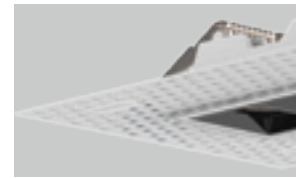

Trimless

ORDERING GUIDE / YOUR PRODUCT CODE



SERIES/LUMEN	INPUT VOLTAGE	CCT	CRI	DIMMING	TRIM	FINISH	REFLECTOR
<input type="radio"/> G4011A-05-W-NC/650lm	<input type="radio"/> 120V	<input type="radio"/> 3000K	<input type="radio"/> 80+	<input type="radio"/> Non-dimming	<input type="radio"/> Trimmed	<input type="radio"/> White	<input type="radio"/> White
<input type="radio"/> G4012A-10-W-NC/1300lm	<input type="radio"/> 230V	<input type="radio"/> 4000K	<input type="radio"/> 90+	<input type="radio"/> TRIAC Dimming	<input type="radio"/> Trimless	<input type="radio"/> Black	<input type="radio"/> Black
<input type="radio"/> G4013A-15-W-NC/1950lm	<input type="radio"/> 277V	<input type="radio"/> 5000K		<input type="radio"/> 0~10V Dimming		<input type="radio"/> Silver	<input type="radio"/> Chrome
	<input type="radio"/> 120-277V						<input type="radio"/> Gold

* Other special requirements please confirm with our factory

LISTING / WARRANTY

ETL listed to US and Canadian standards for damp location W/Feed through.
 3 Years Limited Warranty.

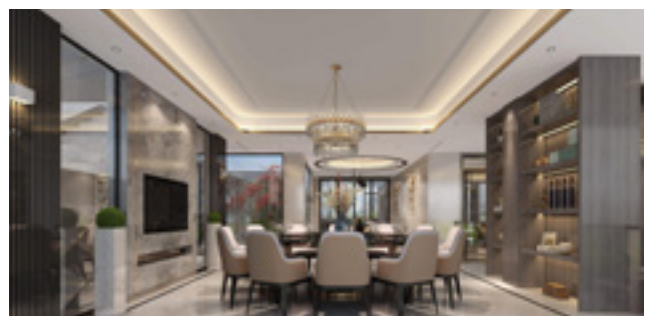



LED WIRELESS SPEAKER LIGHT

Liteharbor LED Wireless Ceiling Light features a unique design, engineered to deliver sound seamlessly. The premium dual speakers project music throughout a room with omni sound while the LED light offers the utmost in energy efficiency.



FASHION LIFE WITH WIRELESS SPEAKER SMART MUSIC CEILING LIGHT

www.i-slite.com

Liteharbor 12" Wireless Speaker Light like an elephant's face and shape of an alien. The Hi-Fi speaker distortion degree lower than 0.01%. Compatible with mobile phones, computers and all wireless devices.

Item No:BL10-BS01

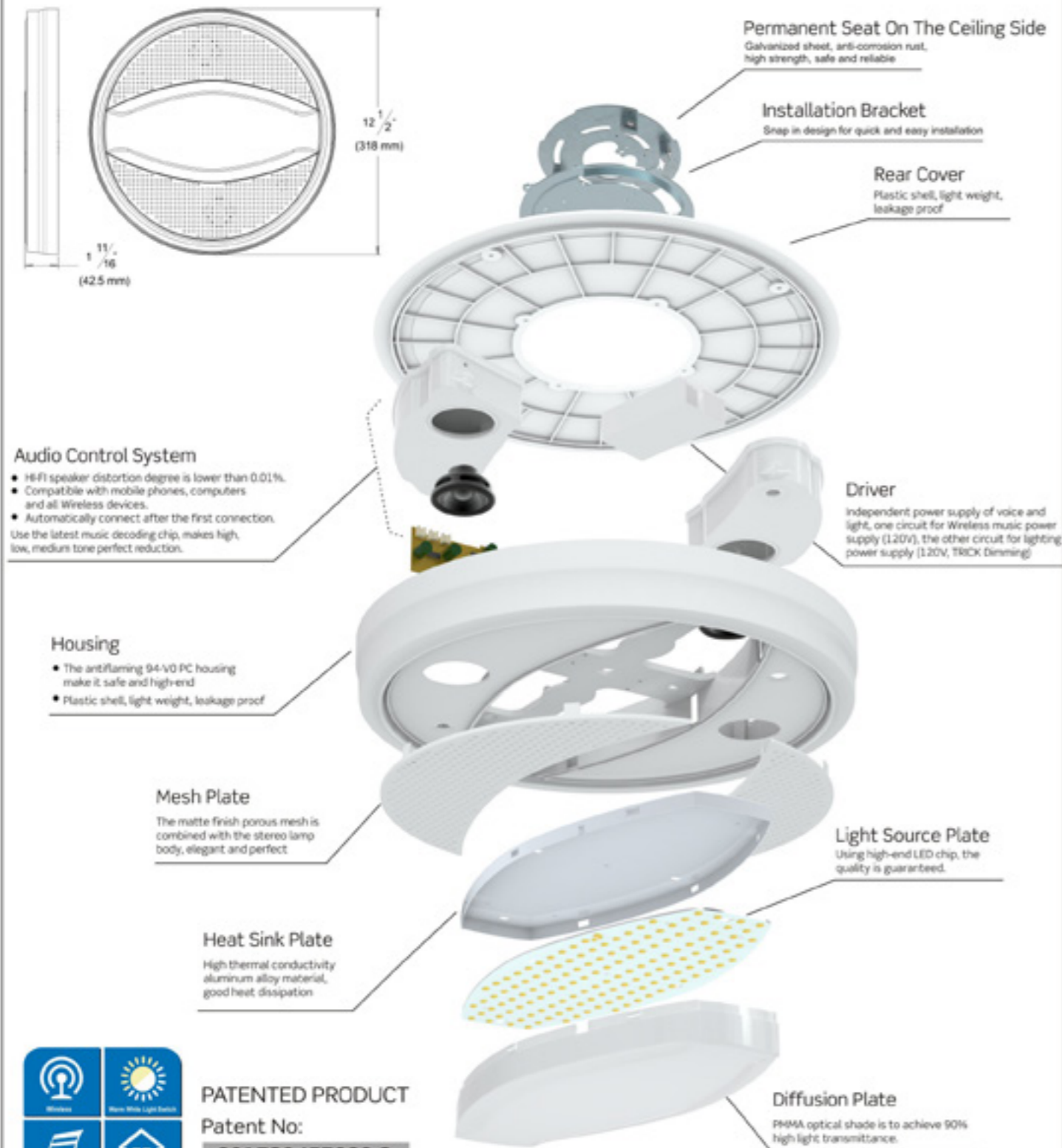

PATENTED PRODUCT
Patent No: 201730457280.3

Ordinary Wireless Speaker Light

When the switch is turned on, the Wireless and light are connected at the same time.

Switchable Wireless Speaker Light

Turn on the switch, the Wireless, indicator light and light will turn on at the same time. Turn on the switch a second time, the Wireless and indicator lights are off, only the light is on. Turn on the switch for the third time, the Wireless and indicator lights are on, and the light is off.

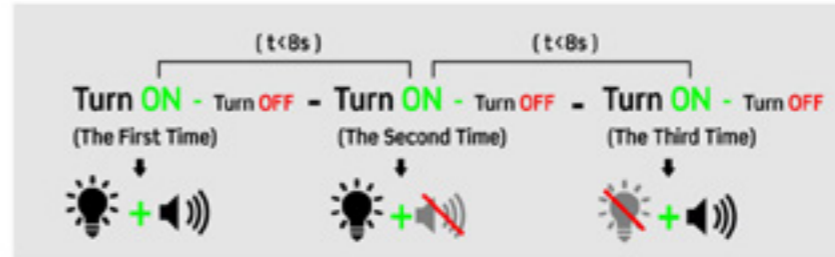

*When switching to the next mode, it will be completed within eight seconds when the switch is pressed.

One main speaker match several speakers connection mode, a main speaker has Wireless functions, others are connected with audio cable, one place can play the same song, the power can be used centralized power supply, control the different lights at the same time.

This version has made a separate indicator light for the Wireless, so that you can know the connection status of Wireless at any time. And this version is non-dimming.

You can also play music when you don't turn on the lights.

Need RGBW version, please consult with our factory.

USE WITH A SINGLE LAMP



WIRELESS CONNECTION INDICATOR LIGHTS

Finish * Customized Also Available Color samples are for reference only, Please prevail in kind.



Lite
Wireless Smart Speaker Light



Installation

Liteharbor LED Wireless Speaker Light can be mounted to ceiling for snap in ceiling installation and pendant mounted. The pendant mounted version can be hung with wires from the high place. In addition to this, we also added a multi-lamp version that offers 3, 4, 7 or 12 lamps for choose, more installation methods and lamps are more suitable for different applications, make your life richer.

Snap in ceiling installation

Suitable for using without embedded boxes



BL10-BS01-FN

Pendant Mounted (Hung with wires)



BL10-BS01-PD



MOUNTING PLATE

Mounting plate is suitable for sites without embedded boxes, such as ordinary cement ceilings, which can hide excess lines like an embedded box. The additional mounting plate can be purchased separately on the website: www.i-s-lite.com or buy at Amazon store - www.amazon.com/shops/lovateamlighting.

Finish

* Customized Also Available

Multi-lamp combinations ceiling mount installation



BL10-BS01-3

BL10-BS01-4

BL10-BS01-7

BL10-BS01-12

Provide multi-lamp combination with 3, 4, 7 or 12 lamps can create a unique shape. And this version is one main speaker matches several speakers connection mode, a main speaker has Wireless functions, others are connected with audio cable, one place can play the same song, and improving auditory experience.



Parking



Retail



Hotel



Bar



Hospitality



Offices

12" LED WIRELESS SPEAKER LIGHT

LIGHT SOURCE SMD CHIPS **BL10-BS01**



FEATURES

All-in-one multi-functional ceiling light, crescent moon shape light emission effect, the modeling is beautiful.
Using high-fidelity speakers, compatible with mobile phones, computers and all other Bluetooth devices, lying on the bed to listen to music, listen to crosstalk, listen to the story, so that light and music linkage.
Automatically connects: After the first connection, each time will be automatically connected when it opening.
Signal qualities: Using high-end chips. Connection distance is far and without noise, no cation phenomenon caused by poor signal.
PC optical lampshade: high Light transmittance.
Bluetooth 4.0 and bluetooth 4.1 both available

APPEARANCE

Like an elephant's face and shape of an alien.
The appearance can do a variety of colors.
Mesh enclosure can be gray, blue, white etc.
Main body can be black, white, gray etc.

MOUNTING

Snap in ceiling installation
Pendent mount
Can be customized as floor lamp.

APPLICATION

Suitable for installation in the bedroom, high-rating hotels, upscale mall, living room, lobby, cafes and other personal and family life.



DIMENSIONS

Ø: 12 1/2"
H: 1 11/16"

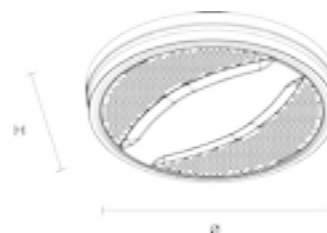

FINISH OPTIONAL: Black White Gray



ORDERING GUIDE / YOUR PRODUCT CODE

SERIES	INPUT VOLTAGE	DIMMABLE	MATERIAL	CCT / CRI	LED AVAILABLE	FINISH	MOUNTING
○ BL10-BS01	○ 120V AC	○ Non-Dimmable	○ ABS	○ 2700K 80+CRI	○ Cree	○ White	○ Ceiling mount
○ LED Wireless Speaker Light	○ 230V AC	○ Dimmable	○ Die Casting Aluminum	○ 2700K 90+CRI	○ Citizen	○ Black	○ Pendent mount
	○ 277V AC			○ 3000K 80+CRI	○ Epistar	○ Gray	○ Can be customized as floor lamp
	○ 90-305V AC			○ 3000K 90+CRI	○ Seoul		
				○ RGBW	○ Osram		

* Customized Also Available

LISTING / WARRANTY

3 Year Limited Warranty.



Liteharbor Harbor of Light!

12" SQUARE SHAPE LED WIRELESS SPEAKER CEILING LIGHT

LIGHT SOURCE SMD CHIPS **BL12-BS01-S**



FEATURES

All-in-one multi-functional ceiling light, crescent moon shape light emission effect, the modeling is beautiful.
Using high-fidelity speakers, compatible with mobile phones, computers and all other Bluetooth devices, lying on the bed to listen to music, listen to crosstalk, listen to the story, so that light and music linkage.
Automatically connects: After the first connection, each time will be automatically connected when it opening.
Signal qualities: Using high-end chips. Connection distance is far and without noise, no cation phenomenon caused by poor signal.
PC optical lampshade: high Light transmittance.
Bluetooth 4.0 and bluetooth 4.1 both available

APPEARANCE

Like an elephant's face and shape of an alien.
The appearance can do a variety of colors.
Mesh enclosure can be gray, blue, white etc.
Main body can be black, white, gray etc.

MOUNTING

Snap in ceiling installation
Pendent mount
Can be customized as floor lamp.

APPLICATION

Suitable for automotive and parking, education, government, healthcare, hospitality, offices, banks, religious, retail.



DIMENSIONS

L: 12 1/2"
W: 12 1/2"
H: 1 11/16"



FINISH OPTIONAL: Black White Gray



ORDERING GUIDE / YOUR PRODUCT CODE

SERIES	INPUT VOLTAGE	DIMMABLE	MATERIAL	CCT / CRI	LED AVAILABLE	FINISH	MOUNTING
○ BL12-BS01-S	○ 120V AC	○ Non-Dimmable	○ ABS	○ 2700K 80+CRI	○ Cree	○ White	○ Ceiling mount
○ 12" Square Shape LED Wireless Speaker Ceiling Light	○ 230V AC	○ Dimmable	○ Die Casting Aluminum	○ 2700K 90+CRI	○ Citizen	○ Black	○ Pendent mount
	○ 277V AC			○ 3000K 80+CRI	○ Epistar	○ Gray	○ Can be customized as floor lamp
	○ 90-305V AC			○ 3000K 90+CRI	○ Seoul		
				○ RGBW	○ Osram		

* Customized Also Available

LISTING / WARRANTY

3 Year Limited Warranty.



E-mail:info@liteharbor.com

16" SQUARE SHAPE LED WIRELESS SPEAKER CEILING LIGHT

LIGHT SOURCE SMD CHIPS **BL16-BS01-S**



FEATURES

All-in-one multi-functional ceiling light, crescent moon shape light emission effect, the modeling is beautiful.
 Using high-fidelity speakers, compatible with mobile phones, computers and all other Bluetooth devices, lying on the bed to listen to music, listen to crosstalk, listen to the story, so that light and music linkage.
 Automatically connects: After the first connection, each time will be automatically connected when it opening.
 Signal qualities: Using high-end chips. Connection distance is far and without noise, no cation phenomenon caused by poor signal.
 PC optical lampshade: high Light transmittance.
 Bluetooth 4.0 and bluetooth 4.1 both available

APPEARANCE

Like an elephant's face and shape of an alien.
 The appearance can do a variety of colors.
 Mesh enclosure can be gray, blue, white etc.
 Main body can be black, white, gray etc.

MOUNTING

Snap in ceiling installation
 Pendant mount
 Can be customized as floor lamp.

APPLICATION

Suitable for automotive and parking, education, government, healthcare, hospitality, offices, banks, religious, retail.

DIMMING	80/90 LED CRI	120V / 230V 277V 90-305VAC Input Voltage	16W Power	100lm/W Luminous Efficiency
---------	---------------	--	-----------	-----------------------------

DIMENSIONS

Ø: 16"
 H: 1 11/16"

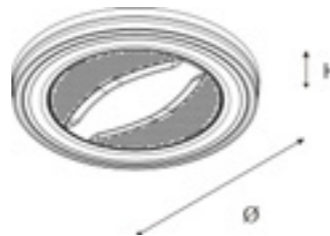

FINISH OPTIONAL: Black White Gray

Search C-Light to download the intelligent APP

4.0-4.2 Bluetooth®

ORDERING GUIDE / YOUR PRODUCT CODE

SERIES	INPUT VOLTAGE	DIMMABLE	MATERIAL	CCT / CRI	LED AVAILABLE	FINISH	MOUNTING
○ BL16-BS01-S 16" Square Shape LED Wireless Speaker Ceiling Light	○ 120V AC	○ Non-Dimmable	○ ABS	○ 2700K 80+CRI	○ Cree	○ White	○ Ceiling mount
	○ 230V AC	○ Dimmable	○ Die Casting Aluminum	○ 2700K 90+CRI	○ Citizen	○ Black	○ Pendant mount
	○ 277V AC			○ 3000K 80+CRI	○ Epistar	○ Gray	○ Can be customized as floor lamp
	○ 90-305V AC			○ 3000K 90+CRI	○ Seoul		
				○ RGBW	○ Osram		

* Customized Also Available

LISTING / WARRANTY

3 Year Limited Warranty.

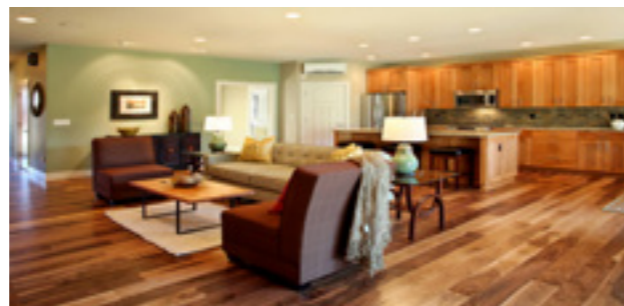

16" SQUARE SHAPE LED WIRELESS SPEAKER CEILING LIGHT

LIGHT SOURCE SMD CHIPS **BL16-BS01-S**

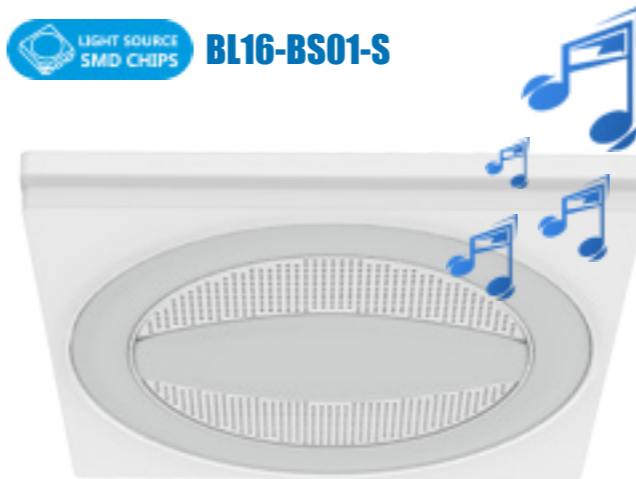

FEATURES

All-in-one multi-functional ceiling light, crescent moon shape light emission effect, the modeling is beautiful.
 Using high-fidelity speakers, compatible with mobile phones, computers and all other Bluetooth devices, lying on the bed to listen to music, listen to crosstalk, listen to the story, so that light and music linkage.
 Automatically connects: After the first connection, each time will be automatically connected when it opening.
 Signal qualities: Using high-end chips. Connection distance is far and without noise, no cation phenomenon caused by poor signal.
 PC optical lampshade: high Light transmittance.
 Bluetooth 4.0 and bluetooth 4.1 both available

APPEARANCE

Like an elephant's face and shape of an alien.
 The appearance can do a variety of colors.
 Mesh enclosure can be gray, blue, white etc.
 Main body can be black, white, gray etc.

MOUNTING

Snap in ceiling installation
 Pendant mount
 Can be customized as floor lamp.

APPLICATION

Suitable for automotive and parking, education, government, healthcare, hospitality, offices, banks, religious, retail.

DIMMING	80/90 LED CRI	120V / 230V 277V 90-305VAC Input Voltage	16W Power	100lm/W Luminous Efficiency
---------	---------------	--	-----------	-----------------------------

DIMENSIONS

L: 16"
 W: 16"
 H: 1 11/16"

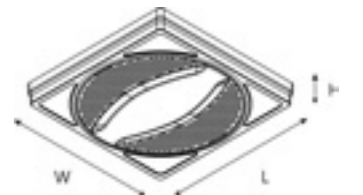

FINISH OPTIONAL: Black White Gray

Search C-Light to download the intelligent APP

4.0-4.2 Bluetooth®

ORDERING GUIDE / YOUR PRODUCT CODE

SERIES	INPUT VOLTAGE	DIMMABLE	MATERIAL	CCT / CRI	LED AVAILABLE	FINISH	MOUNTING
○ BL16-BS01-S 16" Square Shape LED Wireless Speaker Ceiling Light	○ 120V AC	○ Non-Dimmable	○ ABS	○ 2700K 80+CRI	○ Cree	○ White	○ Ceiling mount
	○ 230V AC	○ Dimmable	○ Die Casting Aluminum	○ 2700K 90+CRI	○ Citizen	○ Black	○ Pendant mount
	○ 277V AC			○ 3000K 80+CRI	○ Epistar	○ Gray	○ Can be customized as floor lamp
	○ 90-305V AC			○ 3000K 90+CRI	○ Seoul		
				○ RGBW	○ Osram		

* Customized Also Available

LISTING / WARRANTY

3 Year Limited Warranty.





DECORATIVE FLUSH MOUNT LED CEILING FIXTURES

This ceiling led luminaire offers the appearance of a recessed downlight but is actually flush mounted. This LED ceiling solution offers an affordable alternative to IC airtight recessed housings or Fire-Rated boxes, reducing material and installation costs.

EMERGENCY BATTERY BACKUP

MODULES FOR YOUR CHOICE

www.liteharbor.com

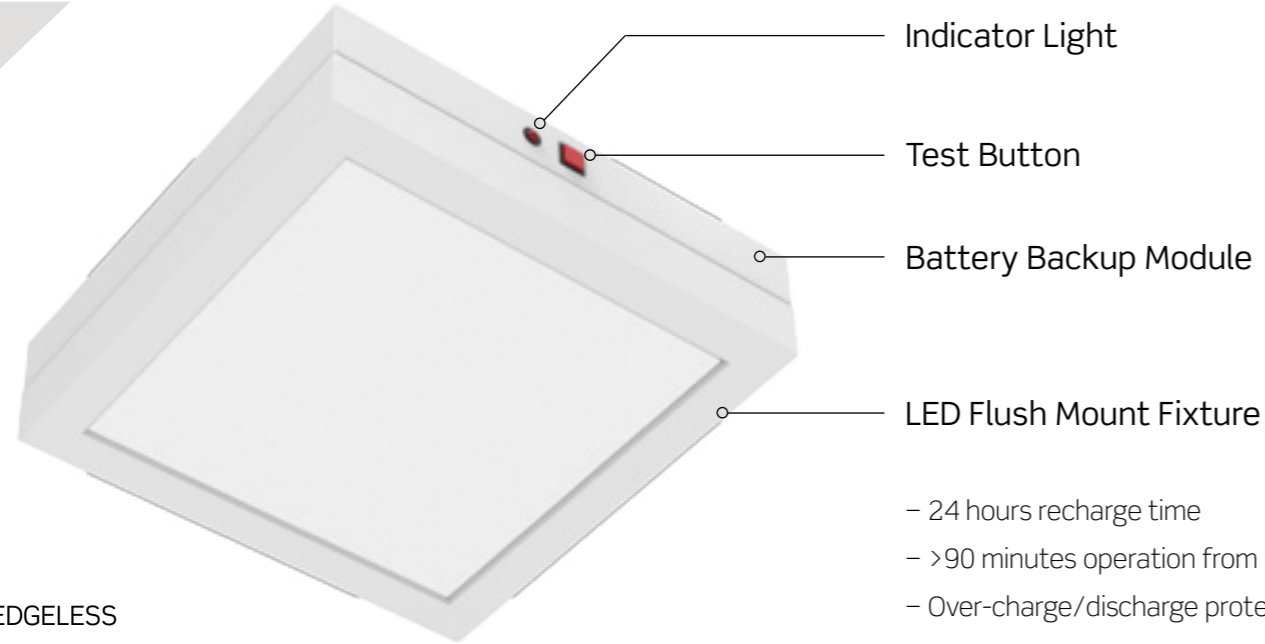

- 24 hours recharge time
- >90 minutes operation from battery
- Over-charge/discharge protection

EDGELESS



PATENT PENDING DESIGN UNIVERSAL BRACKET

ONE Bracket

FOR ALL Flush Mount Ceiling Fixtures

5.5"
7"
9"

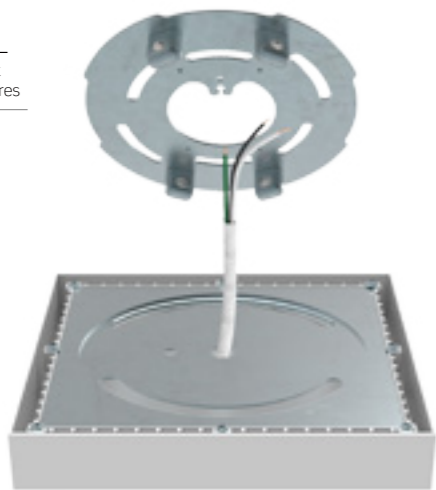

The patent pending design universal bracket can be used for all Liteharbor Flush Mount Ceiling Fixtures (5.5", 7", 9" , round and square all available)



Edgeless

Die-casting aluminum
With so many sizes(5.5",7",9"),
wattages(10.5W-18.5W),
color temperatures(2700-6000K)
and finishes(WH,BK,SN) to choose from,
finding a flush mount LED fixture to decorate your ceiling now!



PRODUCT PARAMETERS

SIZE	SHAPE	INPUT	WATTAGE	LUMEN EFFICIENCY	CCT
5.5"	Round Square	110V/277V AC 50/60 Hz	10.5W	100lm/W	2700~6000K
7"			13.5W		
9"			18.5W		

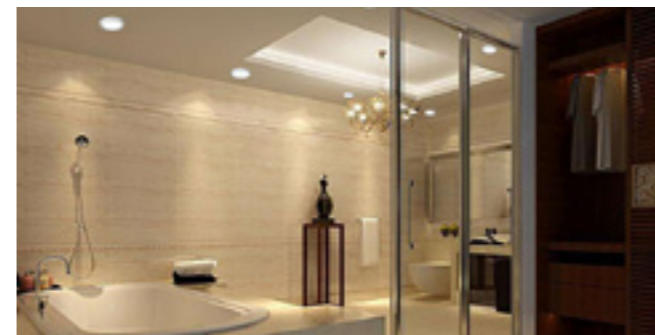

Wet Location Available

IP44 Rated for bathrooms and other damp locations application

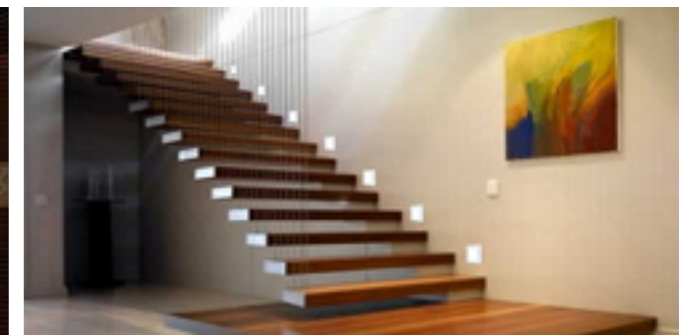

Wall Mount Available

Wall mount applications also available, make your wall more sleek!

5.5" DIE-CAST ALUMINUM ROUND FLUSH MOUNT LED CEILING LIGHT

BL4-FM55



DESCRIPTION

An architecturally pleasing, easy to install and low profile slim LED instant mount round and square aperture downlighting. Slim line, light weight and sleek look, provides more uniform light and an instant on. It is a low profile downlight intended for ceiling or wall mount applications. This luminaire offers the appearance of a recessed downlight but is actually surface mounted.

APPLICATIONS

Slim LED Flush Mount Downlight is characterized by a completely flat lens with a narrow flange, giving it an architecturally pleasing look. This downlighting solution offers an affordable alternative to Air-Seal IC recessed housings or Fire-Rated boxes, reducing material and installation costs.

FEATURES

- LED 5.5" flush mount
- Decorative flush mount LED fixture
- LED 10.5W equal to a traditional 55W lamp
- 80% energy savings
- Damp location listed
- Mounts directly to 3" and 4" junction boxes
- Easy to install
- Die-casting aluminum



DIMENSIONS

H: 1" Ø: 5 1/2"

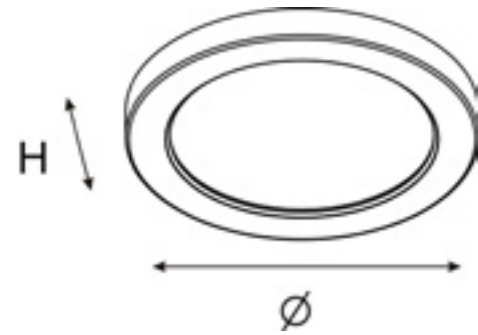

108°

LIGHT DISTRIBUTION

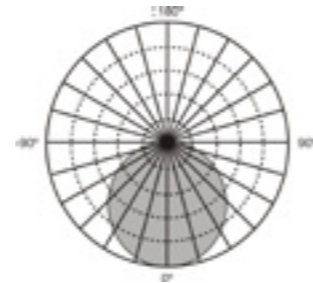

ORDERING GUIDE / YOUR PRODUCT CODE

SERIES	INPUT VOLTAGE	CCT	FINISH	DIMMABLE	CONTROL SYSTEM
○ BL4-FM55 5.5" Round LED Flush Mount	○ 120V	○ 2700K ○ 3000K ○ 4000K ○ 5000K ○ 6000K ○ Tunable(3000K,4000K, 5000K,choose any 2 of them)	○ White ○ Black ○ Satin Nickel	○ Non-Dimmable ○ Dimmable	○ 0-10V & 1-10V ○ DMX512 ○ 3CCT(3500K,4500K,6000K) ○ DALI ○ GRPS Control ○ LED Power Controller ○ PLC ○ SCR ○ SPI ○ WIFI ○ ZIGBEE

* Customized Also Available

LISTING / WARRANTY

ETL listed to US and Canadian standards for damp location W/Feed through. 3 Years Limited Warranty.

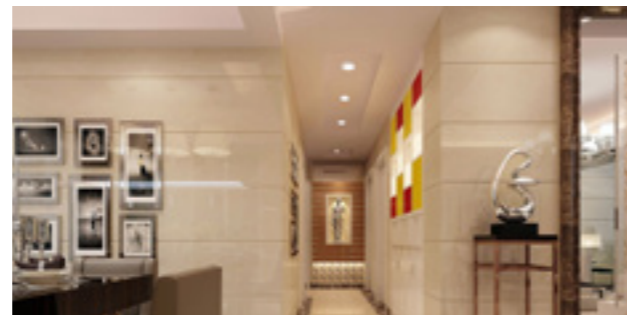

Liteharbor Harbor of Light!

5.5" DIE-CAST ALUMINUM SQUARE FLUSH MOUNT LED CEILING LIGHT

BL4-SFM55



DESCRIPTION

An architecturally pleasing, easy to install and low profile slim LED instant mount round and square aperture downlighting. Slim line, light weight and sleek look, provides more uniform light and an instant on. It is a low profile downlight intended for ceiling or wall mount applications. This luminaire offers the appearance of a recessed downlight but is actually surface mounted.

APPLICATIONS

Slim LED Flush Mount Downlight is characterized by a completely flat lens with a narrow flange, giving it an architecturally pleasing look. This downlighting solution offers an affordable alternative to Air-Seal IC housings or Fire-Rated boxes, reducing material and installation costs.

FEATURES

- LED 5.5" flush mount
- Decorative flush mount LED fixture
- LED 10.5W equal to a traditional 55W lamp
- 80% energy savings
- Damp location listed
- Mounts directly to 3" and 4" junction boxes
- Easy to install
- Die-casting aluminum



DIMENSIONS

H: 1" L: 5 1/2"

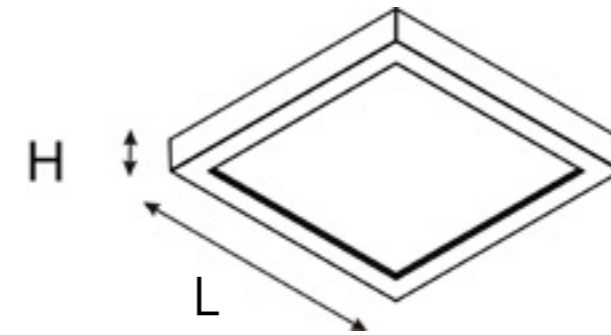

108°

LIGHT DISTRIBUTION

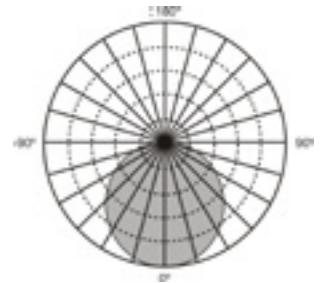

ORDERING GUIDE / YOUR PRODUCT CODE

SERIES	INPUT VOLTAGE	CCT	FINISH	DIMMABLE	CONTROL SYSTEM
○ BL4-SFM55 5.5" Square LED Flush Mount	○ 120V	○ 2700K ○ 3000K ○ 4000K ○ 5000K ○ 6000K ○ Tunable(3000K,4000K, 5000K,choose any 2 of them)	○ White ○ Black ○ Satin Nickel	○ Non-Dimmable ○ Dimmable	○ 0-10V & 1-10V ○ DMX512 ○ 3CCT(3500K,4500K,6000K) ○ DALI ○ GRPS Control ○ LED Power Controller ○ PLC ○ SCR ○ SPI ○ WIFI ○ ZIGBEE

* Customized Also Available

LISTING / WARRANTY

ETL listed to US and Canadian standards for damp location W/Feed through. 3 Years Limited Warranty.



E-mail:info@liteharbor.com

7" DIE-CAST ALUMINUM ROUND FLUSH MOUNT LED CEILING LIGHT

BL6-FM7
LIGHT SOURCE SMD CHIPS



DESCRIPTION

An architecturally pleasing, easy to install and low profile slim LED instant mount round and square aperture downlighting. Slim line, light weight and sleek look, provides more uniform light and an instant on. It is a low profile downlight intended for ceiling or wall mount applications. This luminaire offers the appearance of a recessed downlight but is actually surface mounted.

APPLICATIONS

Slim LED Flush Mount Downlight is characterized by a completely flat lens with a narrow flange, giving it an architecturally pleasing look. This downlighting solution offers an affordable alternative to Air-Seal IC recessed housings or Fire-Rated boxes, reducing material and installation costs.

FEATURES

- LED 7" flush mount
- Decorative flush mount LED fixture
- LED 13.5W equal to a traditional 60W lamp
- 80% energy savings
- Damp location listed
- Mounts directly to 3" and 4" junction boxes
- Easy to install
- Die-casting aluminum

Dimmable	Damp Location	118° Beam-Angle	80/90 CRI	100 _{lm/w} Lumen	13.5 _w Power	2700K / 3000K / 4000K / 5000K / 6000K (CCT)
----------	---------------	-----------------	-----------	---------------------------	-------------------------	---

DIMENSIONS

H: 1" Ø: 7"

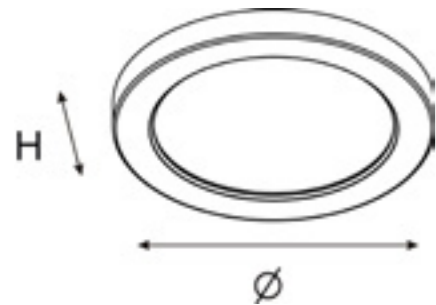

108°

LIGHT DISTRIBUTION

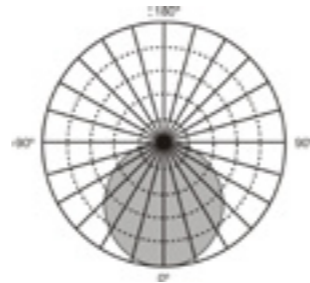

ORDERING GUIDE / YOUR PRODUCT CODE

SERIES	INPUT VOLTAGE	CCT	FINISH	DIMMABLE	CONTROL SYSTEM
○ BL6-FM7 7" Round LED Flush Mount Ceiling Light	○ 120V	○ 2700K ○ 3000K ○ 4000K ○ 5000K ○ 6000K ○ Tunable(3000K,4000K, 5000K,choose any 2 of them)	○ White ○ Black ○ Satin Nickel	○ Non-Dimmable ○ Dimmable	○ 0-10V & 1-10V ○ DMX512 ○ 3CCT(3500K,4500K,6000K) ○ DALI ○ GRPS Control ○ LED Power Controller ○ PLC ○ SCR ○ SPI ○ WIFI ○ ZIGBEE

* Customized Also Available

LISTING / WARRANTY

ETL listed to US and Canadian standards for damp location W/Feed through. 3 Years Limited Warranty.

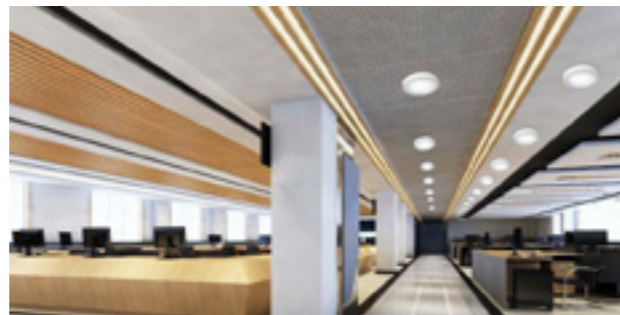

Liteharbor Harbor of Light!

7" DIE-CAST ALUMINUM SQUARE FLUSH MOUNT LED CEILING LIGHT

BL6-SFM7
LIGHT SOURCE SMD CHIPS



DESCRIPTION

An architecturally pleasing, easy to install and low profile slim LED instant mount round and square aperture downlighting. Slim line, light weight and sleek look, provides more uniform light and an instant on. It is a low profile downlight intended for ceiling or wall mount applications. This luminaire offers the appearance of a recessed downlight but is actually surface mounted.

APPLICATIONS

Slim LED Flush Mount Downlight is characterized by a completely flat lens with a narrow flange, giving it an architecturally pleasing look. This downlighting solution offers an affordable alternative to Air-Seal IC recessed housings or Fire-Rated boxes, reducing material and installation costs.

FEATURES

- LED 7" flush mount
- Decorative flush mount LED fixture
- LED 13.5W equal to a traditional 60W lamp
- 80% energy savings
- Damp location listed
- Mounts directly to 3" and 4" junction boxes
- Easy to install
- Die-casting aluminum

DIMENSIONS

H: 1" L: 7"

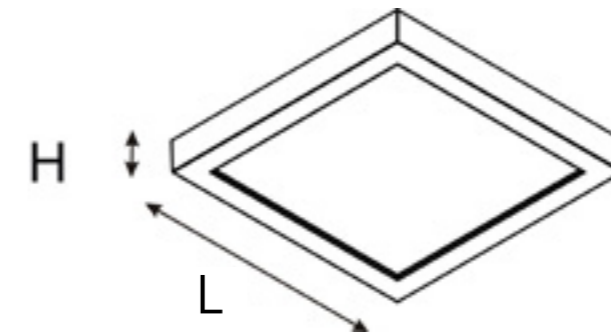

108°

LIGHT DISTRIBUTION

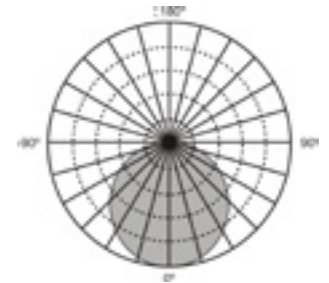

ORDERING GUIDE / YOUR PRODUCT CODE

SERIES	INPUT VOLTAGE	CCT	FINISH	DIMMABLE	CONTROL SYSTEM
○ BL6-SFM7 7" Square LED Flush Mount Ceiling Light	○ 120V	○ 2700K ○ 3000K ○ 4000K ○ 5000K ○ 6000K ○ Tunable(3000K,4000K, 5000K,choose any 2 of them)	○ White ○ Black ○ Satin Nickel	○ Non-Dimmable ○ Dimmable	○ 0-10V & 1-10V ○ DMX512 ○ 3CCT(3500K,4500K,6000K) ○ DALI ○ GRPS Control ○ LED Power Controller ○ PLC ○ SCR ○ SPI ○ WIFI ○ ZIGBEE

* Customized Also Available

LISTING / WARRANTY

ETL listed to US and Canadian standards for damp location W/Feed through. 3 Years Limited Warranty.



E-mail:info@liteharbor.com

9" DIE-CAST ALUMINUM ROUND FLUSH MOUNT LED CEILING LIGHT

BL8-FM9



DESCRIPTION

An architecturally pleasing, easy to install and low profile slim LED instant mount round and square aperture downlighting. Slim line, light weight and sleek look, provides more uniform light and an instant on. It is a low profile downlight intended for ceiling or wall mount applications. This luminaire offers the appearance of a recessed downlight but is actually surface mounted.

APPLICATIONS

Slim LED Flush Mount Downlight is characterized by a completely flat lens with a narrow flange, giving it an architecturally pleasing look. This downlighting solution offers an affordable alternative to Air-Seal IC recessed housings or Fire-Rated boxes, reducing material and installation costs.

FEATURES

- LED 9" flush mount
- Decorative flush mount LED fixture
- LED 18.5W equal to a traditional 100W lamp
- 84% energy savings
- Damp location listed
- Mounts directly to 3" and 4" junction boxes
- Easy to install
- Die-casting aluminum

DIMENSIONS

H: 1"
Ø: 9"

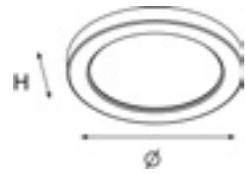

EMERGENCY SYSTEM



- 24 hours recharge time
- >90 minutes operation from battery
- Over-charge/discharge protection

DIMENSIONS

Ø:9"xH:2 3/16"



108°

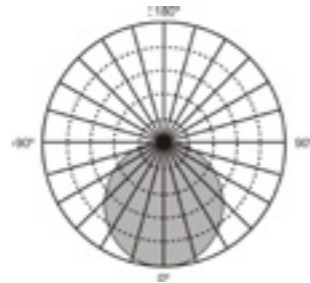

LIGHT DISTRIBUTION

ORDERING GUIDE / YOUR PRODUCT CODE

SERIES	INPUT VOLTAGE	CCT	FINISH	EMERGENCY SYSTEM	CONTROL SYSTEM
○ BL8-FM9 9" Round LED Flush Mount	○ 120V	○ 2700K	○ White	○ Without Emergency Battery Backup	○ 0-10V & 1-10V
		○ 3000K	○ Black		
○ DIMMABLE	○ Non-Dimmable ○ Dimmable	○ 4000K	○ Satin Nickel	○ With Emergency Battery Backup	○ 3CCT(3500K,4500K,6000K)
		○ 5000K			○ DALI
		○ 6000K			○ GRPS Control
		○ Tunable (3000K,4000K, 5000K choose any 2 of them)			○ LED Power Controller
		○ RGB			○ PLC
		○ RGBW		○ SCR	○ SPI
				○ WIFI	○ ZIGBEE

* Customized Also Available

LISTING / WARRANTY

ETL listed to US and Canadian standards for damp location W/Feed through. 3 Years Limited Warranty.



Liteharbor Harbor of Light!

9" DIE-CAST ALUMINUM SQUARE FLUSH MOUNT LED CEILING LIGHT

BL8-SFM9



DESCRIPTION

An architecturally pleasing, easy to install and low profile slim LED instant mount round and square aperture downlighting. Slim line, light weight and sleek look, provides more uniform light and an instant on. It is a low profile downlight intended for ceiling or wall mount applications. This luminaire offers the appearance of a recessed downlight but is actually surface mounted.

APPLICATIONS

Slim LED Flush Mount Downlight is characterized by a completely flat lens with a narrow flange, giving it an architecturally pleasing look. This downlighting solution offers an affordable alternative to Air-Seal IC recessed housings or Fire-Rated boxes, reducing material and installation costs.

FEATURES

- LED 9" flush mount
- Decorative flush mount LED fixture
- LED 18.5W equal to a traditional 100W lamp
- 84% energy savings
- Damp location listed
- Mounts directly to 3" and 4" junction boxes
- Easy to install
- Die-casting aluminum

DIMENSIONS

H: 1"
L: 9"

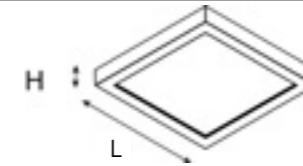

EMERGENCY SYSTEM



- 24 hours recharge time
- >90 minutes operation from battery
- Over-charge/discharge protection

DIMENSIONS

L :9"xH:2 3/16"



108°

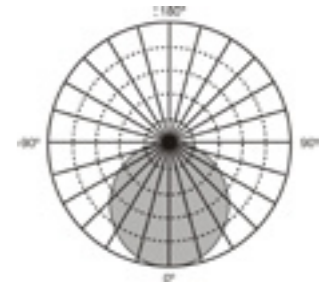

LIGHT DISTRIBUTION

ORDERING GUIDE / YOUR PRODUCT CODE

SERIES	INPUT VOLTAGE	CCT	FINISH	EMERGENCY SYSTEM	CONTROL SYSTEM
○ BL8-SFM9 9" Square LED Flush Mount	○ 120V	○ 2700K	○ White	○ Without Emergency Battery Backup	○ 0-10V & 1-10V
		○ 3000K	○ Black		
○ DIMMABLE	○ Non-Dimmable ○ Dimmable	○ 4000K	○ Satin Nickel	○ With Emergency Battery Backup	○ 3CCT(3500K,4500K,6000K)
		○ 5000K			○ DALI
		○ 6000K			○ GRPS Control
		○ Tunable (3000K,4000K, 5000K choose any 2 of them)			○ LED Power Controller
		○ RGB			○ PLC
		○ RGBW		○ SCR	○ SPI
				○ WIFI	○ ZIGBEE

* Customized Also Available

LISTING / WARRANTY

ETL listed to US and Canadian standards for damp location W/Feed through. 3 Years Limited Warranty.



E-mail:info@liteharbor.com

12 DIE-CAST ALUMINUM INCH FLUSH MOUNTED LED FIXTURE WITH EMERGENCY SYSTEM



DESCRIPTION

An architecturally pleasing, easy to install and low profile slim LED instant mount round and square aperture downlighting. Slim line, light weight and sleek look, provides more uniform light and an instant on. It is a low profile downlight intended for ceiling or wall mount applications. This luminaire offers the appearance of a recessed downlight but is actually surface mounted.

APPLICATIONS

Slim LED Flush Mount Downlight is characterized by a completely flat lens with a narrow flange, giving it an architecturally pleasing look. This downlighting solution offers an affordable alternative to Air-Seal IC recessed housings or Fire-Rated boxes, reducing material and installation costs.

FEATURES

- LED 12" flush mount
- Decorative flush mount LED fixture
- LED 24W equal to a traditional 100W lamp
- 84% energy savings
- Damp location listed
- Mounts directly to 3" and 4" junction boxes
- Easy to install
- Die-casting aluminum

DIMENSIONS

H: 1"
Ø: 12"

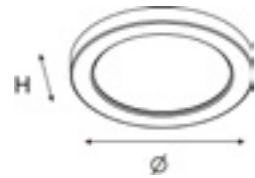

EMERGENCY SYSTEM



- 24 hours recharge time
- >90 minutes operation from battery
- Over-charge/discharge protection

DIMENSIONS

Ø:12"xH:2 3/16"



108°

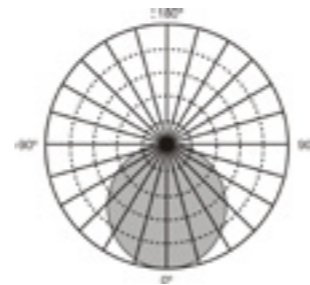

LIGHT DISTRIBUTION

ORDERING GUIDE / YOUR PRODUCT CODE

SERIES	INPUT VOLTAGE	CCT/CRI	FINISH	EMERGENCY SYSTEM	CONTROL SYSTEM
○ BL12-FM11 12" Round LED Flush Mount	○ 120V	○ 3000K/80+	○ White	○ Without Emergency Battery Backup	○ 0-10V & 1-10V
		○ 3000K/90+	○ Black		○ DMX512
○ DIMMABLE	○ Non-Dimmable ○ Dimmable	○ 4000K/80+	○ Satin Nickel	○ With Emergency Battery Backup	○ 3CCT(3500K,4500K,6000K)
		○ 4000K/90+			○ DALI
		○ 5000K/80+			○ GRPS Control
		○ 5000K/90+			○ LED Power Controller
		○ Tunable (3000K,4000K, 5000K,choose any 2 of them)			○ PLC
		○ RGB			○ SCR
		○ RGBW			○ SPI
					○ WIFI
					○ ZIGBEE

* Customized Also Available

LISTING / WARRANTY

ETL listed to US and Canadian standards for damp location W/Feed through. 3 Years Limited Warranty.



Liteharbor Harbor of Light!

12 DIE-CAST ALUMINUM INCH SURFACE MOUNTED LED CEILING LIGHT FIXTURE

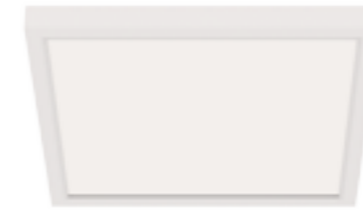

DESCRIPTION

An architecturally pleasing, easy to install and low profile slim LED instant mount round and square aperture downlighting. Slim line, light weight and sleek look, provides more uniform light and an instant on. It is a low profile downlight intended for ceiling or wall mount applications. This luminaire offers the appearance of a recessed downlight but is actually surface mounted.

APPLICATIONS

Slim LED Flush Mount Downlight is characterized by a completely flat lens with a narrow flange, giving it an architecturally pleasing look. This downlighting solution offers an affordable alternative to Air-Seal IC recessed housings or Fire-Rated boxes, reducing material and installation costs.

FEATURES

- LED 12" flush mount
- Decorative flush mount LED fixture
- LED 24W equal to a traditional 100W lamp
- 84% energy savings
- Damp location listed
- Mounts directly to 3" and 4" junction boxes
- Easy to install
- Die-casting aluminum

DIMENSIONS

H: 1"
L: 12"

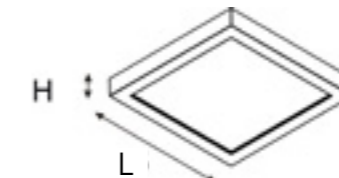

EMERGENCY SYSTEM



- 24 hours recharge time
- >90 minutes operation from battery
- Over-charge/discharge protection

DIMENSIONS

L :12"xH:2 3/16"



108°

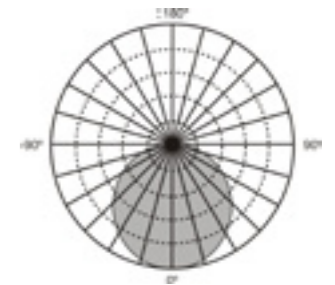

LIGHT DISTRIBUTION

ORDERING GUIDE / YOUR PRODUCT CODE

SERIES	INPUT VOLTAGE	CCT/CRI	FINISH	EMERGENCY SYSTEM	CONTROL SYSTEM
○ BL12-SFM11 12" Square LED Flush Mount	○ 120V	○ 3000K/80+	○ White	○ Without Emergency Battery Backup	○ 0-10V & 1-10V
		○ 3000K/90+	○ Black		○ DMX512
○ DIMMABLE	○ Non-Dimmable ○ Dimmable	○ 4000K/80+	○ Satin Nickel	○ With Emergency Battery Backup	○ 3CCT(3500K,4500K,6000K)
		○ 4000K/90+			○ DALI
		○ 5000K/80+			○ GRPS Control
		○ 5000K/90+			○ LED Power Controller
		○ Tunable			○ PLC
		○ RGB			○ SCR
		○ RGBW			○ SPI
					○ WIFI
					○ ZIGBEE

* Customized Also Available

LISTING / WARRANTY

ETL listed to US and Canadian standards for damp location W/Feed through. 3 Years Limited Warranty.



E-mail:info@liteharbor.com

16 DIE-CAST ALUMINUM INCH ROUND FLUSH MOUNTED LED CEILING LIGHT



DESCRIPTION

An architecturally pleasing, easy to install and low profile slim LED instant mount round and square aperture downlighting. Slim line, light weight and sleek look, provides more uniform light and an instant on. It is a low profile downlight intended for ceiling or wall mount applications. This luminaire offers the appearance of a recessed downlight but is actually surface mounted.

APPLICATIONS

Slim LED Flush Mount Downlight is characterized by a completely flat lens with a narrow flange, giving it an architecturally pleasing look. This downlighting solution offers an affordable alternative to Air-Seal IC recessed housings or Fire-Rated boxes, reducing material and installation costs.

FEATURES

- LED 16" flush mount
- Decorative flush mount LED fixture
- LED 32W equal to a traditional 100W lamp
- 84% energy savings
- Damp location listed
- Mounts directly to 3" and 4" junction boxes
- Easy to install
- Die-casting aluminum

DIMENSIONS

H: 1"
Ø: 16"

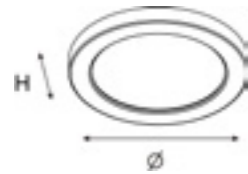

EMERGENCY SYSTEM



- 24 hours recharge time
- >90 minutes operation from battery
- Over-charge/discharge protection

DIMENSIONS

Ø:16"xH:2 3/16"



108°

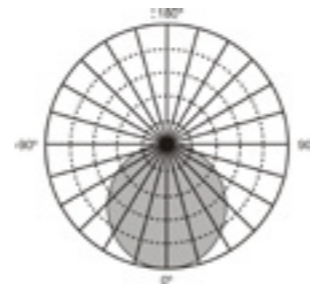

LIGHT DISTRIBUTION

ORDERING GUIDE / YOUR PRODUCT CODE

SERIES	INPUT VOLTAGE	CCT/CRI	FINISH	EMERGENCY SYSTEM	CONTROL SYSTEM
○ BL16-FM15 16" Round LED Flush Mount	○ 120V	○ 3000K/80+	○ White	○ Without Emergency Battery Backup	○ 0-10V & 1-10V
		○ 3000K/90+	○ Black		
		○ 4000K/80+	○ Satin Nickel	○ With Emergency Battery Backup	○ DMX512
		○ 4000K/90+			
		○ 5000K/80+			○ 3CCT(3500K,4500K,6000K)
		○ 5000K/90+			○ DALI
		○ Tunable (3000K,4000K, 5000K,choose any 2 of them)			○ GRPS Control
		○ RGB			○ LED Power Controller
		○ RGBW			○ PLC
					○ SCR
					○ SPI
					○ WIFI
					○ ZIGBEE

* Customized Also Available

LISTING / WARRANTY

ETL listed to US and Canadian standards for damp location W/Feed through. 3 Years Limited Warranty.



Liteharbor Harbor of Light!

16 DIE-CAST ALUMINUM INCH SQUARE FLUSH MOUNTED LED CEILING LIGHT

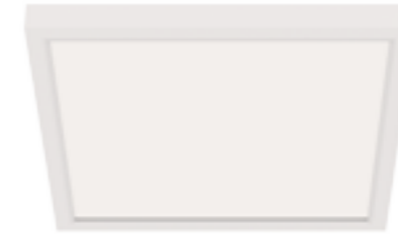

DESCRIPTION

An architecturally pleasing, easy to install and low profile slim LED instant mount round and square aperture downlighting. Slim line, light weight and sleek look, provides more uniform light and an instant on. It is a low profile downlight intended for ceiling or wall mount applications. This luminaire offers the appearance of a recessed downlight but is actually surface mounted.

APPLICATIONS

Slim LED Flush Mount Downlight is characterized by a completely flat lens with a narrow flange, giving it an architecturally pleasing look. This downlighting solution offers an affordable alternative to Air-Seal IC recessed housings or Fire-Rated boxes, reducing material and installation costs.

FEATURES

- LED 16" flush mount
- Decorative flush mount LED fixture
- LED 32W equal to a traditional 100W lamp
- 84% energy savings
- Damp location listed
- Mounts directly to 3" and 4" junction boxes
- Easy to install
- Die-casting aluminum

DIMENSIONS

H: 1"
L: 16"

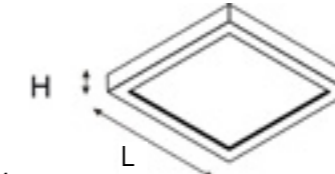

EMERGENCY SYSTEM



- 24 hours recharge time
- >90 minutes operation from battery
- Over-charge/discharge protection

DIMENSIONS

L:16"xH:2 3/16"



108°

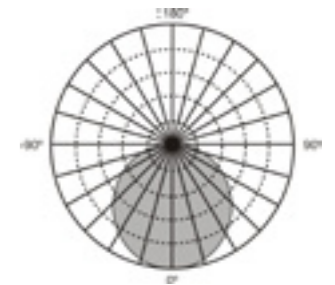

LIGHT DISTRIBUTION

ORDERING GUIDE / YOUR PRODUCT CODE

SERIES	INPUT VOLTAGE	CCT/CRI	FINISH	EMERGENCY SYSTEM	CONTROL SYSTEM
○ BL16-SFM15 16" Square LED Flush Mount	○ 120V	○ 3000K/80+	○ White	○ Without Emergency Battery Backup	○ 0-10V & 1-10V
		○ 3000K/90+	○ Black		
		○ 4000K/80+	○ Satin Nickel	○ With Emergency Battery Backup	○ DMX512
		○ 4000K/90+			
		○ 5000K/80+			○ 3CCT(3500K,4500K,6000K)
		○ 5000K/90+			○ DALI
		○ Tunable (3000K,4000K, 5000K,choose any 2 of them)			○ GRPS Control
		○ RGB			○ LED Power Controller
		○ RGBW			○ PLC
					○ SCR
					○ SPI
					○ WIFI
					○ ZIGBEE

* Customized Also Available

LISTING / WARRANTY

ETL listed to US and Canadian standards for damp location W/Feed through. 3 Years Limited Warranty.



E-mail:info@liteharbor.com

24 DIE-CAST ALUMINUM INCH FLUSH MOUNTED LED CEILING FIXTURES

BL24-FM24



DESCRIPTION

An architecturally pleasing, easy to install and low profile slim LED instant mount round and square aperture downlighting. Slim line, light weight and sleek look, provides more uniform light and an instant on. It is a low profile downlight intended for ceiling or wall mount applications. This luminaire offers the appearance of a recessed downlight but is actually surface mounted.

APPLICATIONS

Slim LED Flush Mount Downlight is characterized by a completely flat lens with a narrow flange, giving it an architecturally pleasing look. This downlighting solution offers an affordable alternative to Air-Seal IC recessed housings or Fire-Rated boxes, reducing material and installation costs.

FEATURES

- LED 24" flush mount
- Decorative flush mount LED fixture
- LED 48W equal to a traditional 100W lamp
- 84% energy savings
- Damp location listed
- Mounts directly to 3" and 4" junction boxes
- Easy to install
- Die-casting aluminum

DIMENSIONS

H: 1"
Ø: 24"

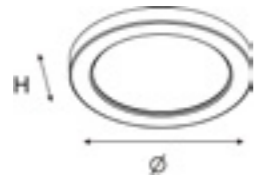

EMERGENCY SYSTEM



- 24 hours recharge time
- >90 minutes operation from battery
- Over-charge/discharge protection

DIMENSIONS

Ø:24"xH:2 3/16"



108°

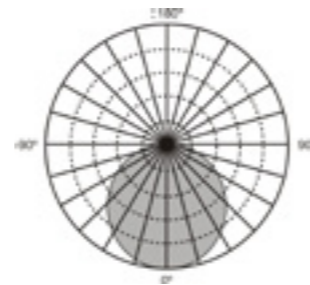

LIGHT DISTRIBUTION

ORDERING GUIDE / YOUR PRODUCT CODE

SERIES	INPUT VOLTAGE	CCT/CRI	FINISH	EMERGENCY SYSTEM	CONTROL SYSTEM
○ BL24-FM24 24" Round LED Flush Mount	○ 120V	○ 3000K/80+	○ White	○ Without Emergency Battery Backup	○ 0-10V & 1-10V
		○ 3000K/90+	○ Black		
○ DIMMABLE	○ Non-Dimmable	○ 4000K/80+	○ Satin Nickel	○ With Emergency Battery Backup	○ 3CCT(3500K,4500K,6000K)
		○ 4000K/90+			
○ Dimmable	○ Dimmable	○ 5000K/80+		○ DALI	○ GRPS Control
		○ 5000K/90+			
		○ Tunable (3000K,4000K, 5000K,choose any 2 of them)		○ LED Power Controller	○ PLC
		○ RGB			
		○ RGBW			○ WIFI
					○ ZIGBEE

* Customized Also Available

LISTING / WARRANTY

ETL listed to US and Canadian standards for damp location W/Feed through. 3 Years Limited Warranty.



Liteharbor Harbor of Light!

24 DIE-CAST ALUMINUM INCH SQUARE DECORATIVE LED CEILING FIXTURES

BL24-SFM24



DESCRIPTION

An architecturally pleasing, easy to install and low profile slim LED instant mount round and square aperture downlighting. Slim line, light weight and sleek look, provides more uniform light and an instant on. It is a low profile downlight intended for ceiling or wall mount applications. This luminaire offers the appearance of a recessed downlight but is actually surface mounted.

APPLICATIONS

Slim LED Flush Mount Downlight is characterized by a completely flat lens with a narrow flange, giving it an architecturally pleasing look. This downlighting solution offers an affordable alternative to Air-Seal IC recessed housings or Fire-Rated boxes, reducing material and installation costs.

FEATURES

- LED 24" flush mount
- Decorative flush mount LED fixture
- LED 48W equal to a traditional 100W lamp
- 84% energy savings
- Damp location listed
- Mounts directly to 3" and 4" junction boxes
- Easy to install
- Die-casting aluminum

DIMENSIONS

H: 1"
L: 24"

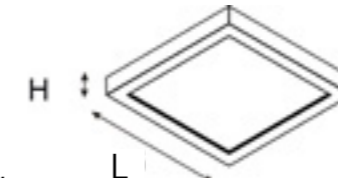

EMERGENCY SYSTEM



- 24 hours recharge time
- >90 minutes operation from battery
- Over-charge/discharge protection

DIMENSIONS

L:24"xH:2 3/16"



108°

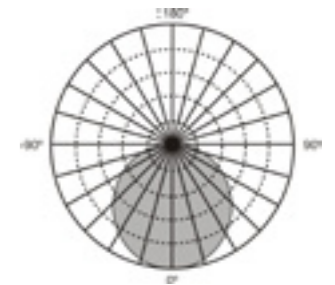

LIGHT DISTRIBUTION

ORDERING GUIDE / YOUR PRODUCT CODE

SERIES	INPUT VOLTAGE	CCT/CRI	FINISH	EMERGENCY SYSTEM	CONTROL SYSTEM
○ BL24-SFM24 24" Square LED Flush Mount	○ 120V	○ 3000K/80+	○ White	○ Without Emergency Battery Backup	○ 0-10V & 1-10V
		○ 3000K/90+	○ Black		
○ DIMMABLE	○ Non-Dimmable	○ 4000K/80+	○ Satin Nickel	○ With Emergency Battery Backup	○ 3CCT(3500K,4500K,6000K)
		○ 4000K/90+			
○ Dimmable	○ Dimmable	○ 5000K/80+		○ DALI	○ GRPS Control
		○ 5000K/90+			
		○ Tunable (3000K,4000K, 5000K,choose any 2 of them)		○ LED Power Controller	○ PLC
		○ RGB			
		○ RGBW			○ WIFI
					○ ZIGBEE

* Customized Also Available

LISTING / WARRANTY

ETL listed to US and Canadian standards for damp location W/Feed through. 3 Years Limited Warranty.



E-mail:info@liteharbor.com

5 INCH ROUND SHAPE EDGELESS FLUSH MOUNTED LED CEILING LIGHT

LIGHT SOURCE SMD CHIPS **BL4-FM55-TL**



DESCRIPTION

An architecturally pleasing, easy to install and low profile slim LED instant mount round and square aperture downlighting. Slim line, light weight and sleek look, provides more uniform light and an instant on. It is a low profile downlight intended for ceiling or wall mounted applications. This luminaire offers the appearance of a recessed downlight but is actually surface mounted.

SPECIFICATION

Lamp Body: Made of die casting aluminum, the material is light and has good heat dissipation performance.
Light Source: Use big brand highlight lamp beads, 80+/90+ CRI and multiple CCT(3000K,4000K,5000K,6500K) are optional.

FEATURES

Edgeless for a minimal aesthetic that blends seamlessly into the ceiling.
Premier quality light engine: produces up to 1000 lumens of exceptional light.
Decorative flush mounted LED fixture.
Dimming: Non-dimming/TRIAC Dimming.
Mounts directly to 3" and 4" junction boxes.
5" outside diameter, larger than most products of the same size, can perfectly cover the mark left by the old lamps in the ceiling when the lamps are updated.
Easy to install.

DIMENSIONS

H: 1"
Ø: 5"

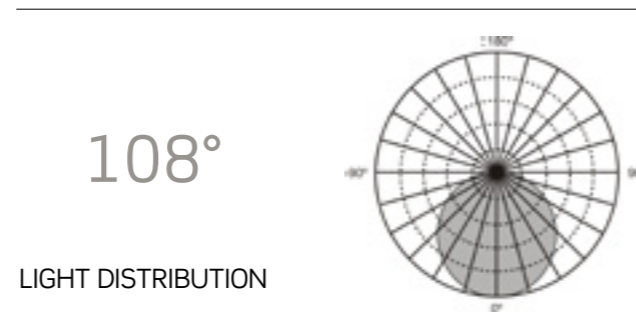
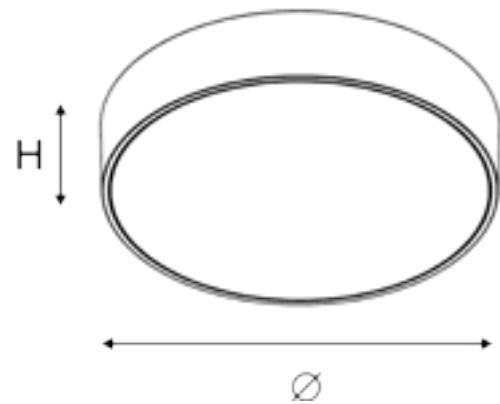

ORDERING GUIDE / YOUR PRODUCT CODE

SERIES	WATT	INPUT VOLTAGE	DIMMABLE	CCT	CRI	FINISH
○ BL4-FM55-TL LED Ceiling Light	○ 8W ○ 10W ○ 12W	○ 120V	○ Non-Dimmable ○ TRIAC Dimming	○ 3000K ○ 4000K ○ 5000K ○ 6000K * 3000K,4000K, 5000K,choose any 2 of them)	○ 80+ ○ 90+	○ White ○ Black

* Other special requirements please confirm with our factory

LISTING / WARRANTY

ETL listed to US and Canadian standards for damp location W/Feed through.
3 Years Limited Warranty.

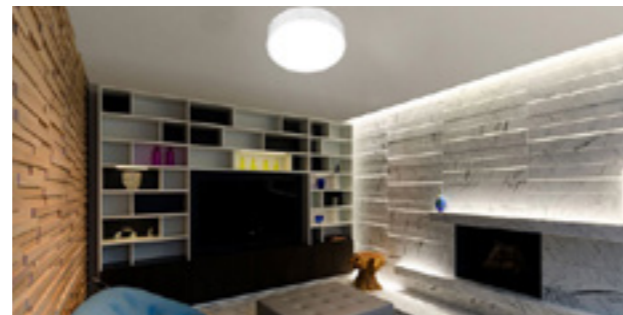

Liteharbor Harbor of Light!

5 INCH SQUARE SHAPE EDGELESS FLUSH MOUNTED LED CEILING LIGHT

LIGHT SOURCE SMD CHIPS **BL4-FM55-TL**



DESCRIPTION

An architecturally pleasing, easy to install and low profile slim LED instant mount round and square aperture downlighting. Slim line, light weight and provides more uniform light and an instant on. It is a low profile downlight intended for ceiling or wall mounted applications. This luminaire offers the appearance of a recessed downlight but is actually surface mounted.

SPECIFICATION

Lamp Body: Made of die casting aluminum, the material is light and has good heat dissipation performance.
Light Source: Use big brand highlight lamp beads, 80+/90+ CRI and multiple CCT(3000K,4000K,5000K,6500K) are optional.

FEATURES

Edgeless for a minimal aesthetic that blends seamlessly into the ceiling.
Premier quality light engine: produces up to 1000 lumens of exceptional light.
Decorative flush mounted LED fixture.
Dimming: Non-dimming/TRIAC Dimming.
Mounts directly to 3" and 4" junction boxes.
5" outside diameter, larger than most products of the same size, can perfectly cover the mark left by the old lamps in the ceiling when the lamps are updated.
Easy to install.

DIMENSIONS

H: 1"
L: 5"

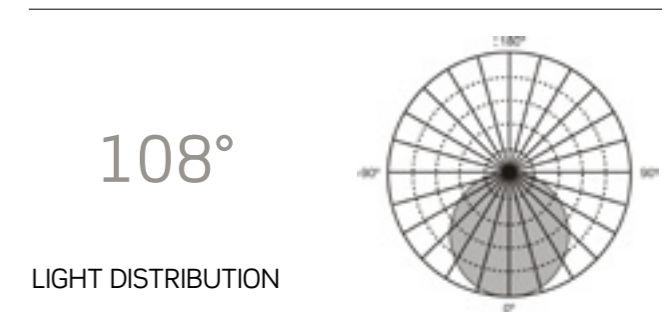
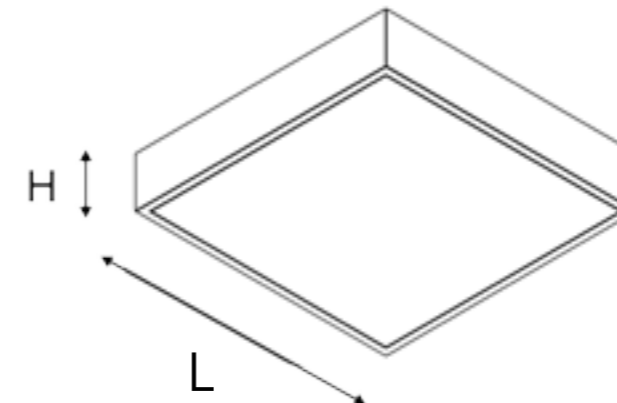

ORDERING GUIDE / YOUR PRODUCT CODE

SERIES	WATT	INPUT VOLTAGE	DIMMABLE	CCT	CRI	FINISH
○ BL4-SFM55-TL LED Ceiling Light	○ 8W ○ 10W ○ 12W	○ 120V	○ Non-Dimmable ○ TRIAC Dimming	○ 3000K ○ 4000K ○ 5000K ○ 6000K * 3000K,4000K, 5000K,choose any 2 of them)	○ 80+ ○ 90+	○ White ○ Black

* Other special requirements please confirm with our factory

LISTING / WARRANTY

ETL listed to US and Canadian standards for damp location W/Feed through.
3 Years Limited Warranty.

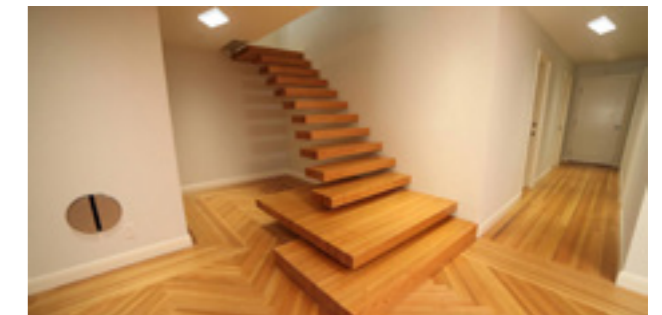

E-mail:info@liteharbor.com

INSTALLATION INSTRUCTION

5.5" & 7" & 9" Round/Square LED Ceiling Fixtures

INSTALLATION- - - - -Seven simple steps.

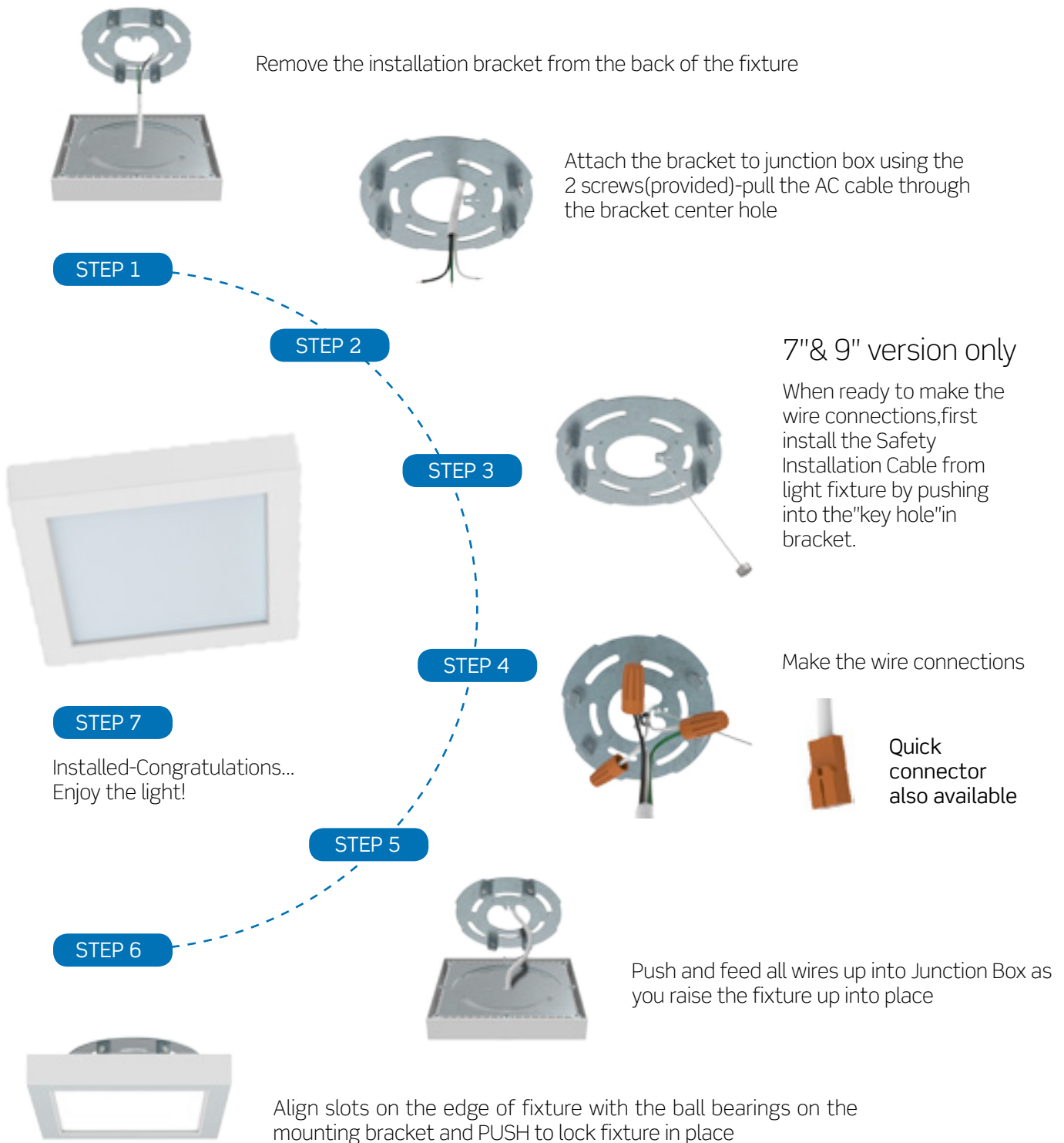



LED PENDANT LIGHT

Liteharbor LED Pendant Lights bring a unique sense of style to any space. Choose from modern pendant lights to add a statement to any room and create striking looks with our pendant lighting collection. Light your space and look the way you want it.

DIE-CAST ALUMINUM ROUND LED PENDANT LIGHT

BL4-FM55-P



BL4-FM55-P

BL4-FM55-P2

DESCRIPTION

An architecturally pleasing, easy to install and low profile slim LED pendant mount round and square aperture downlighting. Slim line, light weight and sleek look, provides more uniform light and an instant on. It is a low profile pendant light intended for ceiling applications.

APPLICATIONS

Slim LED pendant mount ceiling light is characterized by a completely flat lens with a narrow flange, giving it an architecturally pleasing look. Can used for all residential, office, commercial and retail or hospitality high ceiling applications.

FEATURES

Decorative LED pendant ceiling light fixture
Equal to a traditional 50W lamp
80% energy savings
Damp location listed
Easy to install
High Quality Die-cast Aluminum Material

EMERGENCY

24 hours recharge time
>90 minutes operation from battery
Over-charge/discharge protection

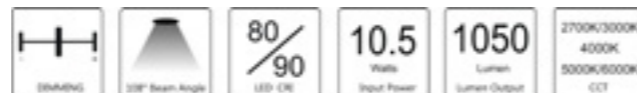

DIMENSIONS

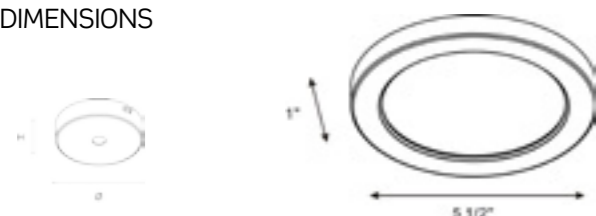

CANOPY: Ø: 3 15/16"xH: 7/8"

108°

LIGHT DISTRIBUTION

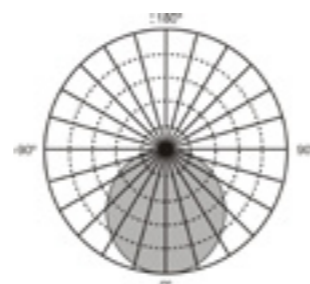

ORDERING GUIDE / YOUR PRODUCT CODE

SERIES	LENGTH	INPUT VOLTAGE	CCT	Finish	Emergency System	CONTROL SYSTEM
<input type="radio"/> BL4-FM55-P	<input type="radio"/> 6"	<input type="radio"/> 120V	<input type="radio"/> 2700K	<input type="radio"/> White	<input type="radio"/> Without Emergency Battery Backup	<input type="radio"/> 0-10V & 1-10V
<input type="radio"/> BL4-FM55-P2	<input type="radio"/> 12"	<input type="checkbox"/> Dimmable <input type="radio"/> NON-Dimmable <input type="radio"/> Dimmable	<input type="radio"/> 3000K	<input type="radio"/> Black	<input type="radio"/> With Emergency Battery Backup	<input type="radio"/> DMX512
	<input type="radio"/> 18"		<input type="radio"/> 4000K	<input type="radio"/> Satin Nickel		<input type="radio"/> 3CCT(3500K,4500K,6000K)
	<input type="radio"/> 24"		<input type="radio"/> 5000K			<input type="radio"/> DALI
	<input type="radio"/> 36"		<input type="radio"/> 6000K			<input type="radio"/> GRPS Control
	<input type="radio"/> 48"		<input type="radio"/> Tunable (3000K,4000K, 5000K,choose any 2 of them)			<input type="radio"/> LED Power Controller
			<input type="radio"/> RGB		<input type="radio"/> PLC	
			<input type="radio"/> RGBW		<input type="radio"/> SCR	
					<input type="radio"/> SPI	
					<input type="radio"/> WIFI	
					<input type="radio"/> ZIGBEE	

* Customized Also Available

LISTING / WARRANTY

ETL listed to US and Canadian standards for damp location W/Feed through.
3 Years Limited Warranty.



Liteharbor Harbor of Light!

DIE-CAST ALUMINUM SQUARE LED PENDANT LIGHT

BL4-SFM55-P



BL4-SFM55-P

BL4-SFM55-P2

DESCRIPTION

An architecturally pleasing, easy to install and low profile slim LED pendant mount round and square aperture downlighting. Slim line, light weight and sleek look, provides more uniform light and an instant on. It is a low profile pendant light intended for ceiling applications.

APPLICATIONS

Slim LED pendant mount ceiling light is characterized by a completely flat lens with a narrow flange, giving it an architecturally pleasing look. Can used for all residential, office, commercial and retail or hospitality high ceiling applications.

FEATURES

Decorative LED pendant ceiling light fixture
Equal to a traditional 50W lamp
80% energy savings
Damp location listed
Easy to install
High Quality Die-cast Aluminum Material

EMERGENCY

24 hours recharge time
>90 minutes operation from battery
Over-charge/discharge protection



DIMENSIONS

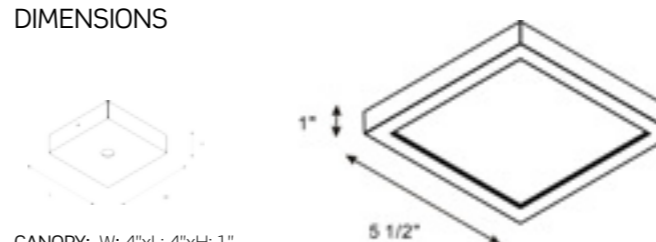

CANOPY: W: 4"xL: 4"xH: 1"

108°

LIGHT DISTRIBUTION

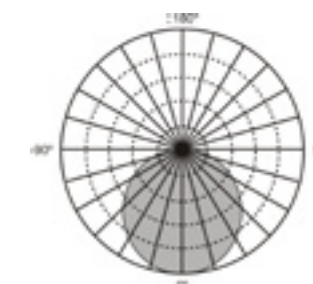

ORDERING GUIDE / YOUR PRODUCT CODE

SERIES	LENGTH	INPUT VOLTAGE	CCT	Finish	Emergency System	CONTROL SYSTEM
<input type="radio"/> BL4-SFM55-P	<input type="radio"/> 6"	<input type="radio"/> 120V	<input type="radio"/> 2700K	<input type="radio"/> White	<input type="radio"/> Without Emergency Battery Backup	<input type="radio"/> 0-10V & 1-10V
<input type="radio"/> BL4-SFM55-P2	<input type="radio"/> 12"	<input type="checkbox"/> Dimmable <input type="radio"/> NON-Dimmable <input type="radio"/> Dimmable	<input type="radio"/> 3000K	<input type="radio"/> Black	<input type="radio"/> With Emergency Battery Backup	<input type="radio"/> DMX512
	<input type="radio"/> 18"		<input type="radio"/> 4000K	<input type="radio"/> Satin Nickel	<input type="radio"/> 3CCT(3500K,4500K,6000K)	
	<input type="radio"/> 24"		<input type="radio"/> 5000K		<input type="radio"/> DALI	
	<input type="radio"/> 36"		<input type="radio"/> 6000K		<input type="radio"/> GRPS Control	
	<input type="radio"/> 48"		<input type="radio"/> Tunable (3000K,4000K, 5000K,choose any 2 of them)		<input type="radio"/> LED Power Controller	
			<input type="radio"/> RGB		<input type="radio"/> PLC	
			<input type="radio"/> RGBW		<input type="radio"/> SCR	
					<input type="radio"/> SPI	
					<input type="radio"/> WIFI	
					<input type="radio"/> ZIGBEE	

* Customized Also Available

LISTING / WARRANTY

ETL listed to US and Canadian standards for damp location W/Feed through.
3 Years Limited Warranty.



E-mail:info@liteharbor.com

DIE-CAST ALUMINUM ROUND LED PENDANT LIGHT

BL6-FM7-P



DESCRIPTION

An architecturally pleasing, easy to install and low profile slim LED pendant mount round and square aperture downlighting. Slim line, light weight and sleek look, provides more uniform light and an instant on. It is a low profile pendant light intended for ceiling applications.

APPLICATIONS

Slim LED pendant mount ceiling light is characterized by a completely flat lens with a narrow flange, giving it an architecturally pleasing look. Can used for all residential, office, commercial and retail or hospitality high ceiling applications.

FEATURES

Decorative LED pendant ceiling light fixture
 Equal to a traditional 60W lamp
 80% energy savings
 Damp location listed
 Easy to install
 High quality die cast aluminum material

EMERGENCY

24 hours recharge time
 >90 minutes operation from battery
 Over-charge/discharge protection

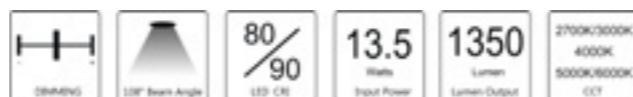

DIMENSIONS

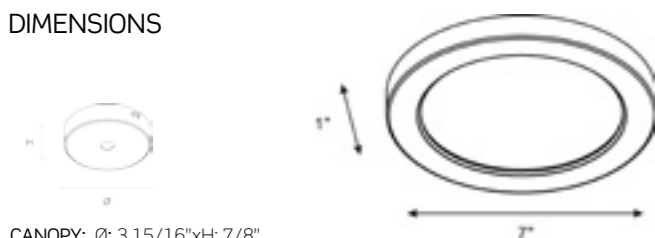

CANOPY: Ø: 3 15/16"xH: 7/8"

108°

LIGHT DISTRIBUTION

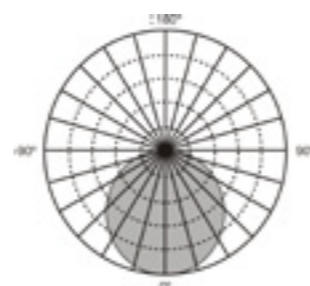

ORDERING GUIDE / YOUR PRODUCT CODE

SERIES	LENGTH	INPUT VOLTAGE	CCT	Finish	Emergency System	CONTROL SYSTEM
<input type="radio"/> BL6-FM7-P	<input type="radio"/> 6"	<input type="radio"/> 120V	<input type="radio"/> 2700K	<input type="radio"/> White	<input type="radio"/> Without Emergency Battery Backup	<input type="radio"/> 0-10V & 1-10V
<input type="radio"/> BL6-FM7-P2	<input type="radio"/> 12"	<input type="checkbox"/> Dimmable <input type="radio"/> NON-Dimmable <input type="checkbox"/> Dimmable	<input type="radio"/> 3000K	<input type="radio"/> Black	<input type="radio"/> With Emergency Battery Backup	<input type="radio"/> DMX512
7" Round LED Pendant Mount	<input type="radio"/> 18"		<input type="radio"/> 4000K	<input type="radio"/> Satin Nickel		<input type="radio"/> 3CCT(3500K,4500K,6000K)
	<input type="radio"/> 24"		<input type="radio"/> 5000K	<input type="radio"/> DALI		
	<input type="radio"/> 36"		<input type="radio"/> 6000K	<input type="radio"/> GRPS Control		
<input type="radio"/> 48"	<input type="radio"/> Tunable (3000K,4000K, 5000K,choose any 2 of them)		<input type="radio"/> LED Power Controller			
			<input type="radio"/> RGB	<input type="radio"/> PLC	<input type="radio"/> SCR	<input type="radio"/> SPI
			<input type="radio"/> RGBW	<input type="radio"/> WIFI	<input type="radio"/> ZIGBEE	

* Customized Also Available

LISTING / WARRANTY

ETL listed to US and Canadian standards for damp location W/Feed through.
 3 Years Limited Warranty.



Liteharbor Harbor of Light!

DIE-CAST ALUMINUM SQUARE LED PENDANT LIGHT

BL6-SFM7-P



DESCRIPTION

An architecturally pleasing, easy to install and low profile slim LED pendant mount round and square aperture downlighting. Slim line, light weight and sleek look, provides more uniform light and an instant on. It is a low profile pendant light intended for ceiling applications.

APPLICATIONS

Slim LED pendant mount ceiling light is characterized by a completely flat lens with a narrow flange, giving it an architecturally pleasing look. Can used for all residential, office, commercial and retail or hospitality high ceiling applications.

FEATURES

Decorative LED pendant ceiling light fixture
 Equal to a traditional 60W lamp
 80% energy savings
 Damp location listed
 Easy to install
 High quality die cast aluminum material

EMERGENCY

24 hours recharge time
 >90 minutes operation from battery
 Over-charge/discharge protection



DIMENSIONS

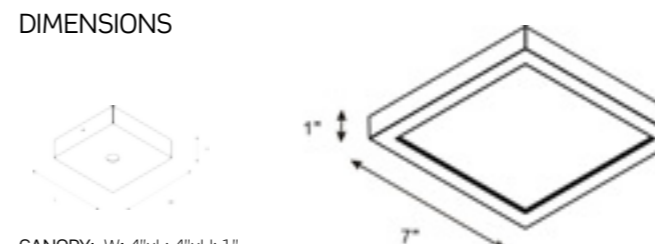

CANOPY: W: 4"xL: 4"xH: 1"

108°

LIGHT DISTRIBUTION

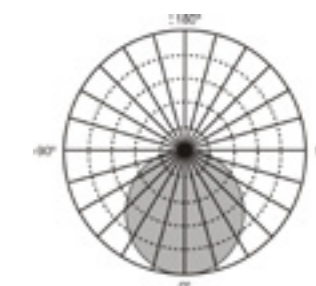

ORDERING GUIDE / YOUR PRODUCT CODE

SERIES	LENGTH	INPUT VOLTAGE	CCT	Finish	Emergency System	CONTROL SYSTEM
<input type="radio"/> BL6-SFM7-P	<input type="radio"/> 6"	<input type="radio"/> 120V	<input type="radio"/> 2700K	<input type="radio"/> White	<input type="radio"/> Without Emergency Battery Backup	<input type="radio"/> 0-10V & 1-10V
<input type="radio"/> BL6-SFM7-P2	<input type="radio"/> 12"	<input type="checkbox"/> Dimmable <input type="radio"/> NON-Dimmable <input type="checkbox"/> Dimmable	<input type="radio"/> 3000K	<input type="radio"/> Black	<input type="radio"/> With Emergency Battery Backup	<input type="radio"/> DMX512
7" Square LED Pendant Mount	<input type="radio"/> 18"		<input type="radio"/> 4000K	<input type="radio"/> Satin Nickel		<input type="radio"/> 3CCT(3500K,4500K,6000K)
	<input type="radio"/> 24"		<input type="radio"/> 5000K	<input type="radio"/> DALI		
	<input type="radio"/> 36"		<input type="radio"/> 6000K	<input type="radio"/> GRPS Control		
<input type="radio"/> 48"	<input type="radio"/> Tunable (3000K,4000K, 5000K,choose any 2 of them)		<input type="radio"/> LED Power Controller			
			<input type="radio"/> RGB	<input type="radio"/> PLC	<input type="radio"/> SCR	<input type="radio"/> SPI
			<input type="radio"/> RGBW	<input type="radio"/> WIFI	<input type="radio"/> ZIGBEE	

* Customized Also Available

LISTING / WARRANTY

ETL listed to US and Canadian standards for damp location W/Feed through.
 3 Years Limited Warranty.

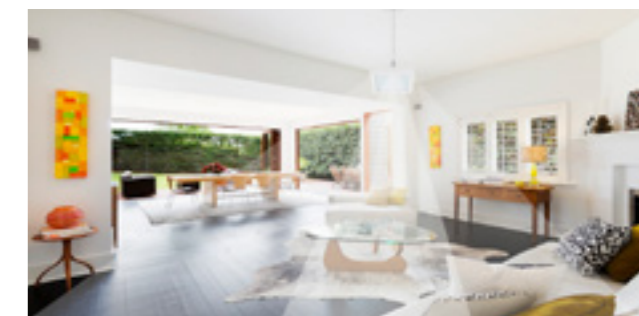

www.liteharbor.com

E-mail:info@liteharbor.com

DIE-CAST ALUMINUM ROUND LED PENDANT LIGHT

BL8-FM9-P



DESCRIPTION

An architecturally pleasing, easy to install and low profile slim LED pendant mount round and square aperture downlighting. Slim line, light weight and sleek look, provides more uniform light and an instant on. It is a low profile pendant light intended for ceiling applications.

APPLICATIONS

Slim LED pendant mount ceiling light is characterized by a completely flat lens with a narrow flange, giving it an architecturally pleasing look. Can used for all residential, office, commercial and retail or hospitality high ceiling applications.

FEATURES

Decorative LED pendant ceiling light fixture
 Equal to a traditional 50W lamp
 80% energy savings
 Damp location listed
 Easy to install
 High quality die cast aluminum material

EMERGENCY

24 hours recharge time
 >90 minutes operation from battery
 Over-charge/discharge protection



DIMENSIONS

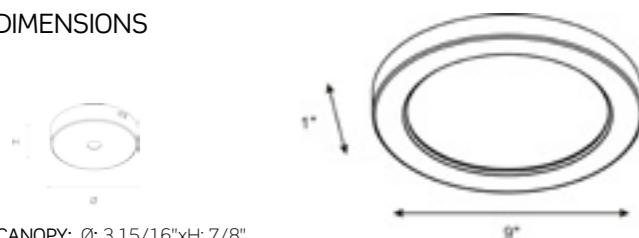

CANOPY: Ø: 3 15/16\"/>

108°

LIGHT DISTRIBUTION

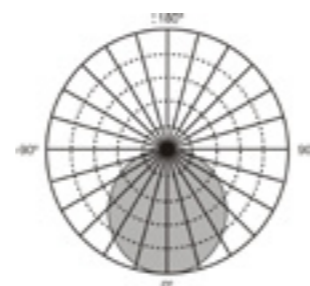

ORDERING GUIDE / YOUR PRODUCT CODE

SERIES	LENGTH	INPUT VOLTAGE	CCT	Finish	Emergency System	CONTROL SYSTEM
○ BL8-FM9-P	○ 6"	○ 120V	○ 2700K	○ White	○ Without Emergency Battery Backup	○ 0-10V & 1-10V
○ BL8-FM9-P2	○ 12"		○ 3000K	○ Black		○ DMX512
○ 9" Round LED Pendant Mount	○ 18"	Dimmable ○ NON-Dimmable ○ Dimmable	○ 4000K	○ Satin Nickel	○ With Emergency Battery Backup	○ 3CCT(3500K,4500K,6000K)
	○ 24"		○ 5000K			○ DALI
	○ 36"		○ 6000K			○ GRPS Control
	○ 48"		○ Tunable (3000K,4000K, 5000K,choose any 2 of them)			○ LED Power Controller
			○ RGB			○ PLC
			○ RGBW			○ SCR
						○ SPI
						○ WIFI
						○ ZIGBEE

* Customized Also Available

LISTING / WARRANTY

ETL listed to US and Canadian standards for damp location W/Feed through. 3 Years Limited Warranty.



Liteharbor Harbor of Light!

DIE-CAST ALUMINUM ROUND LED PENDANT LIGHT

BL8-SFM9-P



DESCRIPTION

An architecturally pleasing, easy to install and low profile slim LED pendant mount round and square aperture downlighting. Slim line, light weight and sleek look, provides more uniform light and an instant on. It is a low profile pendant light intended for ceiling applications.

APPLICATIONS

Slim LED pendant mount ceiling light is characterized by a completely flat lens with a narrow flange, giving it an architecturally pleasing look. Can used for all residential, office, commercial and retail or hospitality high ceiling applications.

FEATURES

Decorative LED pendant ceiling light fixture
 Equal to a traditional 50W lamp
 80% energy savings
 Damp location listed
 Easy to install
 High quality die cast aluminum material

EMERGENCY

24 hours recharge time
 >90 minutes operation from battery
 Over-charge/discharge protection



DIMENSIONS

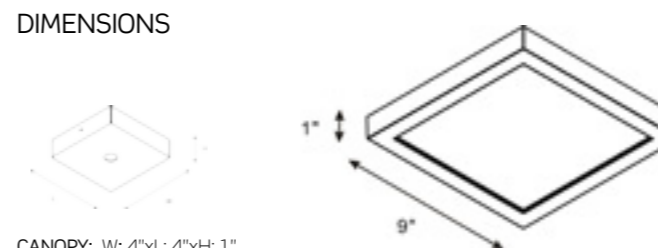

CANOPY: W: 4\"/>

108°

LIGHT DISTRIBUTION

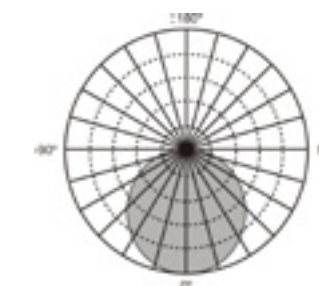

ORDERING GUIDE / YOUR PRODUCT CODE

SERIES	LENGTH	INPUT VOLTAGE	CCT	Finish	Emergency System	CONTROL SYSTEM
○ BL8-SFM9-P	○ 6"	○ 120V	○ 2700K	○ White	○ Without Emergency Battery Backup	○ 0-10V & 1-10V
○ BL8-SFM9-P2	○ 12"		○ 3000K	○ Black		○ DMX512
○ 9" Round LED Pendant Mount	○ 18"	Dimmable ○ NON-Dimmable ○ Dimmable	○ 4000K	○ Satin Nickel	○ With Emergency Battery Backup	○ 3CCT(3500K,4500K,6000K)
	○ 24"		○ 5000K			○ DALI
	○ 36"		○ 6000K			○ GRPS Control
	○ 48"		○ Tunable (3000K,4000K, 5000K,choose any 2 of them)			○ LED Power Controller
			○ RGB			○ PLC
			○ RGBW			○ SCR
						○ SPI
						○ WIFI
						○ ZIGBEE

* Customized Also Available

LISTING / WARRANTY

ETL listed to US and Canadian standards for damp location W/Feed through. 3 Years Limited Warranty.

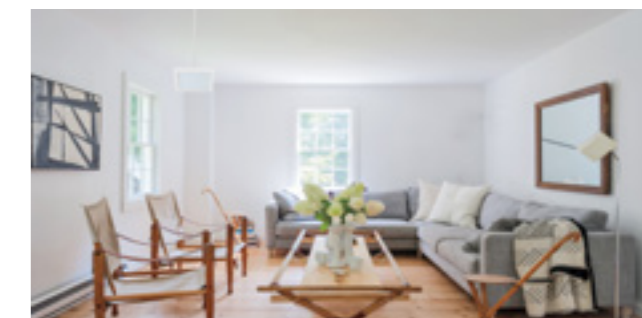

E-mail:info@liteharbor.com

DIE-CAST ALUMINUM ROUND LED PENDANT LIGHT

PD-BL-FM3C



DESCRIPTION

An architecturally pleasing, easy to install and low profile slim LED pendant mount round and square aperture downlighting. Slim line, light weight and sleek look, provides more uniform light and an instant on. It is a low profile pendant light intended for ceiling applications.

APPLICATIONS

Slim LED pendant mount ceiling light is characterized by a completely flat lens with a narrow flange, giving it an architecturally pleasing look. Can used for all residential, office, commercial and retail or hospitality high ceiling applications.

FEATURES

Decorative LED pendant ceiling light fixture
80% energy savings
Damp location listed
Easy to install
Die cast aluminum material

EMERGENCY

24 hours recharge time
>90 minutes operation from battery
Over-charge/discharge protection



LENGTH 6"/12"/18"/24"/36"/48"

DIMENSIONS

CANOPY:



W: 25 3/16"xL: 2 3/8"xH: 1"

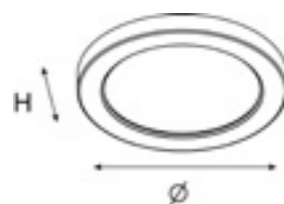

H: 1" Ø1: 5 1/2" Ø2: 7" Ø3: 9"

108°

LIGHT DISTRIBUTION

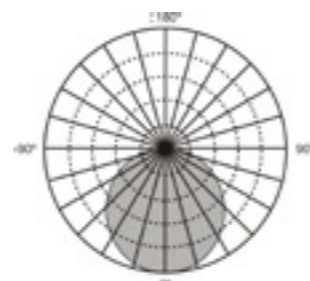

ORDERING GUIDE / YOUR PRODUCT CODE

SERIES	LENGTH	INPUT VOLTAGE	CCT	Finish	Emergency System	CONTROL SYSTEM
○ PD-BL-FM3C Round LED Pendant Mount	○ 6"	○ 120V Dimmable ○ NON-Dimmable ○ Dimmable	○ 2700K	○ White ○ Black ○ Satin Nickel	○ Without Emergency Battery Backup ○ With Emergency Battery Backup	○ 0-10V & 1-10V
	○ 12"		○ 3000K			○ DMX512
	○ 18"		○ 4000K			○ 3CCT(3500K,4500K,6000K)
	○ 24"		○ 5000K	○ DALI		
	○ 36"		○ 6000K	○ GRPS Control		
	○ 48"		○ Tunable (3000K,4000K, 5000K,choose any 2 of them)	○ LED Power Controller		
			○ RGB	○ PLC		
			○ RGBW	○ SCR		
				○ SPI		
				○ WIFI		
		○ ZIGBEE				

* Customized Also Available

LISTING / WARRANTY

ETL listed to US and Canadian standards for damp location W/Feed through. 3 Years Limited Warranty.

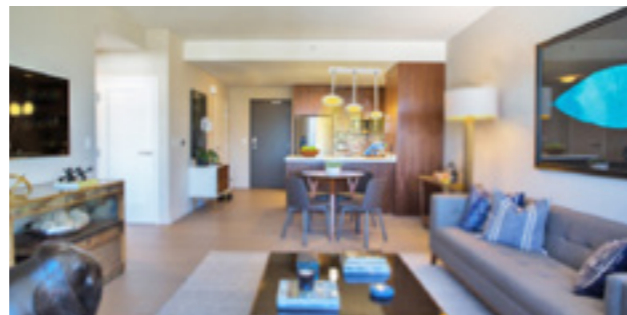

DIE-CAST ALUMINUM ROUND LED PENDANT LIGHT

PD-BL-FM3C-S



DESCRIPTION

An architecturally pleasing, easy to install and low profile slim LED pendant mount round and square aperture downlighting. Slim line, light weight and sleek look, provides more uniform light and an instant on. It is a low profile pendant light intended for ceiling applications.

APPLICATIONS

Slim LED pendant mount ceiling light is characterized by a completely flat lens with a narrow flange, giving it an architecturally pleasing look. Can used for all residential, office, commercial and retail or hospitality high ceiling applications.

FEATURES

Decorative LED pendant ceiling light fixture
80% energy savings
Damp location listed
Easy to install
Die cast aluminum material

EMERGENCY

24 hours recharge time
>90 minutes operation from battery
Over-charge/discharge protection



LENGTH 6"/12"/18"/24"/36"/48"

DIMENSIONS

CANOPY:

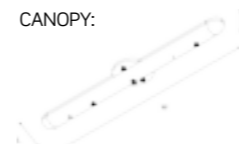

W: 25 3/16"xL: 4 1/8"xH: 1 1/4"

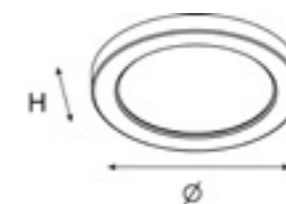

H: 1" Ø1: 5 1/2" Ø2: 7" Ø3: 9"

108°

LIGHT DISTRIBUTION

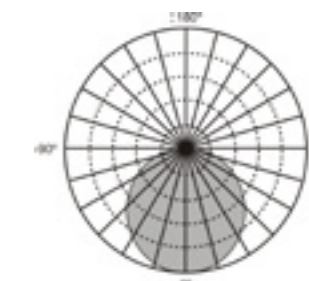

ORDERING GUIDE / YOUR PRODUCT CODE

SERIES	LENGTH	INPUT VOLTAGE	CCT	Finish	Emergency System	CONTROL SYSTEM
○ PD-BL-FM3C-S Round LED Suspended Mount	○ 6"	○ 120V Dimmable ○ NON-Dimmable ○ Dimmable	○ 2700K	○ White ○ Black ○ Satin Nickel	○ Without Emergency Battery Backup ○ With Emergency Battery Backup	○ 0-10V & 1-10V
	○ 12"		○ 3000K			○ DMX512
	○ 18"		○ 4000K			○ 3CCT(3500K,4500K,6000K)
	○ 24"		○ 5000K	○ DALI		
	○ 36"		○ 6000K	○ GRPS Control		
	○ 48"		○ Tunable (3000K,4000K, 5000K,choose any 2 of them)	○ LED Power Controller		
			○ RGB	○ PLC		
			○ RGBW	○ SCR		
				○ SPI		
				○ WIFI		
		○ ZIGBEE				

* Customized Also Available

LISTING / WARRANTY

ETL listed to US and Canadian standards for damp location W/Feed through. 3 Years Limited Warranty.



DIE-CAST ALUMINUM SQUARE LED PENDANT LIGHT

PD-BL-SFM3C



DESCRIPTION

An architecturally pleasing, easy to install and low profile slim LED pendant mount round and square aperture downlighting. Slim line, light weight and sleek look, provides more uniform light and an instant on. It is a low profile pendant light intended for ceiling applications.

APPLICATIONS

Slim LED pendant mount ceiling light is characterized by a completely flat lens with a narrow flange, giving it an architecturally pleasing look. Can used for all residential, office, commercial and retail or hospitality high ceiling applications.

FEATURES

- Decorative LED pendant ceiling light fixture
- 80% energy savings
- Damp location listed
- Easy to install
- Die cast aluminum material

EMERGENCY

- 24 hours recharge time
- >90 minutes operation from battery
- Over-charge/discharge protection



LENGTH 6"/12"/18"/24"/36"/48"

DIMENSIONS

CANOPY:

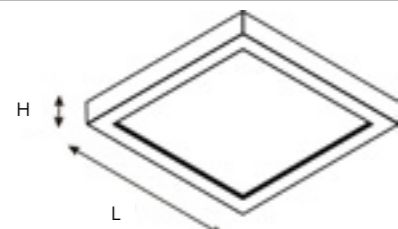
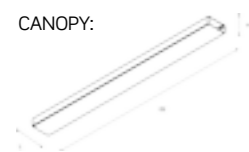

W: 25 3/16"xL: 2 3/8"xH: 1" H: 1" L1: 5 1/2" L2: 7" L3: 9"

108°

LIGHT DISTRIBUTION

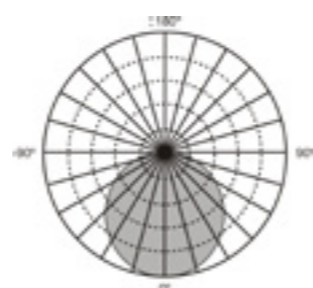

ORDERING GUIDE / YOUR PRODUCT CODE

SERIES	LENGTH	INPUT VOLTAGE	CCT	Finish	Emergency System	CONTROL SYSTEM
○ PD-BL-SFM3C Square LED Pendant Mount	○ 6"	○ 120V	○ 2700K	○ White	○ Without Emergency Battery Backup	○ 0-10V & 1-10V
	○ 12"		○ 3000K	○ Black		
	○ 18"	Dimmable	○ 4000K	○ Satin Nickel	○ With Emergency Battery Backup	○ 3CCT(3500K,4500K,6000K)
	○ 24"		○ 5000K			
	○ 36"		○ 6000K			
	○ 48"		○ Tunable (3000K,4000K, 5000K,choose any 2 of them)			
			○ RGB			
			○ RGBW			
			○ DALI			
			○ GRPS Control			
		○ LED Power Controller				
		○ PLC				
		○ SCR				
		○ SPI				
		○ WIFI				
		○ ZIGBEE				

* Customized Also Available

LISTING / WARRANTY

ETL listed to US and Canadian standards for damp location W/Feed through. 3 Years Limited Warranty.



Liteharbor Harbor of Light!

DIE-CAST ALUMINUM SQUARE LED PENDANT LIGHT

PD-BL-SFM3C-S



DESCRIPTION

An architecturally pleasing, easy to install and low profile slim LED pendant mount round and square aperture downlighting. Slim line, light weight and sleek look, provides more uniform light and an instant on. It is a low profile pendant light intended for ceiling applications.

APPLICATIONS

Slim LED pendant mount ceiling light is characterized by a completely flat lens with a narrow flange, giving it an architecturally pleasing look. Can used for all residential, office, commercial and retail or hospitality high ceiling applications.

FEATURES

- Decorative LED pendant ceiling light fixture
- 80% energy savings
- Damp location listed
- Easy to install
- Die cast aluminum material

EMERGENCY

- 24 hours recharge time
- >90 minutes operation from battery
- Over-charge/discharge protection

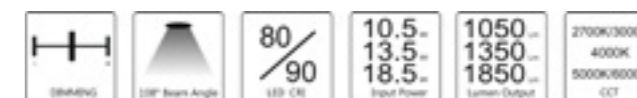

LENGTH 6"/12"/18"/24"/36"/48"

DIMENSIONS

CANOPY:

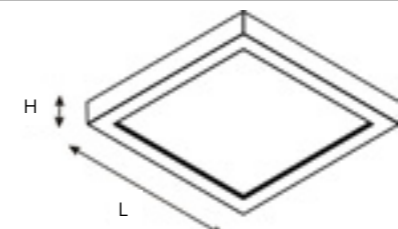
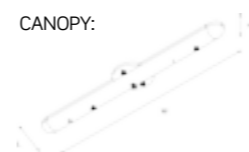

W: 25 3/16"xL: 4 1/8"xH: 1 1/4" H: 1" L1: 5 1/2" L2: 7" L3: 9"

108°

LIGHT DISTRIBUTION

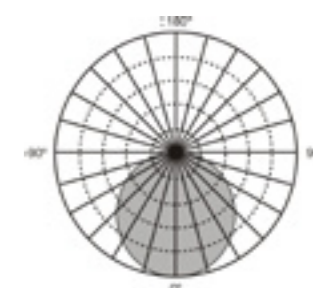

ORDERING GUIDE / YOUR PRODUCT CODE

SERIES	LENGTH	INPUT VOLTAGE	CCT	Finish	Emergency System	CONTROL SYSTEM
○ PD-BL-SFM3C-S Square LED Pendant Mount	○ 6"	○ 120V	○ 2700K	○ White	○ Without Emergency Battery Backup	○ 0-10V & 1-10V
	○ 12"		○ 3000K	○ Black		
	○ 18"	Dimmable	○ 4000K	○ Satin Nickel	○ With Emergency Battery Backup	○ 3CCT(3500K,4500K,6000K)
	○ 24"		○ 5000K			
	○ 36"		○ 6000K			
	○ 48"		○ Tunable (3000K,4000K, 5000K,choose any 2 of them)			
			○ RGB			
			○ RGBW			
			○ DALI			
			○ GRPS Control			
		○ LED Power Controller				
		○ PLC				
		○ SCR				
		○ SPI				
		○ WIFI				
		○ ZIGBEE				

* Customized Also Available

LISTING / WARRANTY

ETL listed to US and Canadian standards for damp location W/Feed through. 3 Years Limited Warranty.



E-mail:info@liteharbor.com



HIGH PERFORMANCE LED COB TRACK LIGHT SERIES

Liteharbor LED track fixtures feature dimmable integral LED drivers in a fashionable, classic design. Offering powerful lighting performance and maximum energy efficiency, these highly advanced fixtures are ideal for retail, residential and commercial accent lighting applications.

HIGH PERFORMANCE LED COB TRACK LIGHT SERIES

Liteharbor High Performance LED COB Track Light Series offers numerous LED solutions that increase efficiency and revenue, while most importantly providing the customers with a comfortable and relaxing experience that keeps them coming back.



- 1 Adaptor**
Optional adaptor, can be global or square, available in single or two-circuit
- 2 Power Supply**
The high quality power supply is adjacent from the LED engine to increase efficiency and ensure optimal performance. The minimum power factor rating for the power supply is 0.95. ELV dimming control is offered as a standard in most luminaires.
- 3 Thermal Management**
LED mounted to die-cast/extruded aluminum heat sink with active cooling, these heatsinks are designed to dissipate heat well below the recommended operating junction temperature. Ensuring 50000 hours of operation at 70% lumen depreciation.



- 4 High Performance LED Chip—COB**
High output LED provide powerful uniform, vertical and horizontal illumination. These compact high flux density light sources deliver uniform, high quality illumination without pixilation.
- 5 Reflectors**
High quality 1.5mm thickness aluminum reflector with diffused anodized finish.

Color Temperature(CCT)

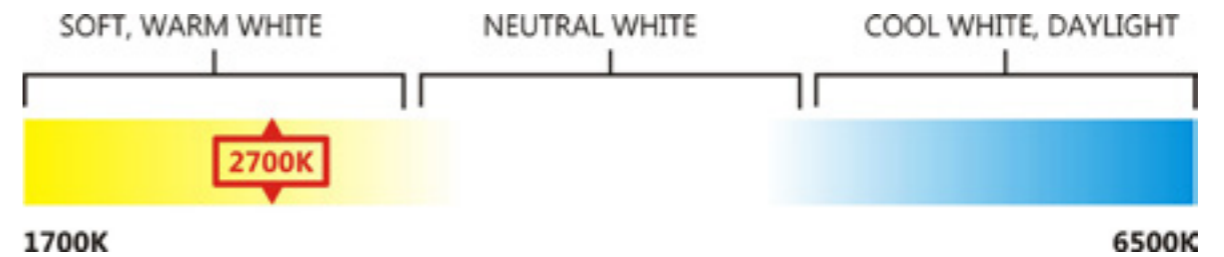

Liteharbor High Performance COB LED Track Lights are available in a wide range of color temperature, Series fixtures are available in 2700K, 3000K, 3500K, 4000K and 6000K color temperatures with a minimum 80 CRI for excellent color rendering. Optional high CRI versions offer 90 CRI minimum.

Color Rendering Index(CRI)

Color sample	Ra	R1	R2	R3	R4	R5	R6	R7	R8	R9	R10	R11	R12	R13	R14	R15
CRI 80+	81	80	85	89	81	78	80	86	66	16	64	79	58	81	93	75
CRI 95+	98	98	99	98	98	98	97	98	98	96	99	98	88	98	98	98
Radiant CRI 80+	81	81	86	89	81	80	80	85	68	16	66	80	62	82	93	77
Radiant CRI 95+	95	99	98	97	96	98	96	95	94	90	97	95	97	98	98	98

Color Rendering options comparison, 3000K

Liteharbor High Performance COB LED Track Lights Series is available in two CRI options, 80+ or 90+. The 90+ CRI option is only available in 2700K and 3000K. 90+ CRI delivers a premium high color rendering LED light source.

Beam Angle

Patent pending precision optical system that produces uniform spot, narrow flood, or flood beam distributions with minimal field angle illumination.

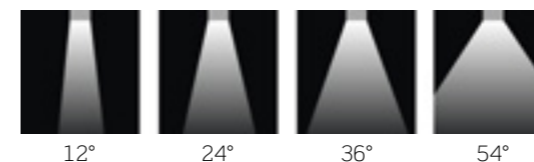

Dimming (0-10V Dimmer)

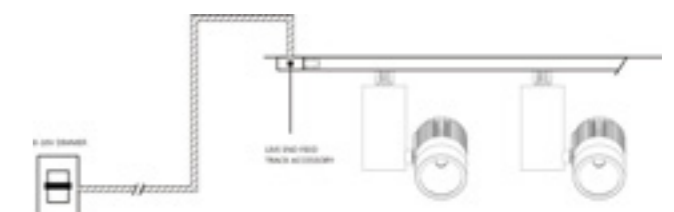

IDEAL FOR A BROAD RANGE OF APPLICATION

Retail

Liteharbor's High Performance COB Track Light is an ideal choice for showcasing high-end retail merchandise or museum quality items. Impression will take visual merchandising to a new level bringing out the vibrant colors, patterns and textures of your merchandise.



Hospitality

With lighting applications such as lobbies, corridors, hotel rooms or restaurants, Liteharbor's Track Spot Light provides a versatile array of options. Each fixture offers fine details, high-end quality, high performance and low maintenance all covered by a 10-year product warranty.



Commercial

Liteharbor's Track Spots are ideal for lobbies and office spaces where wall washing or general lighting is required.

Its low-maintenance qualities and longevity make a practical and functional lighting solution ideal for high ceilings and "difficult to access" areas.



Residential

Liteharbor's Track Spot Lights offer a low wattage version designed specifically for residential applications. Homeowners love the sleek design, optimum glare control and creative use of state-of-the-art technology in the product line.

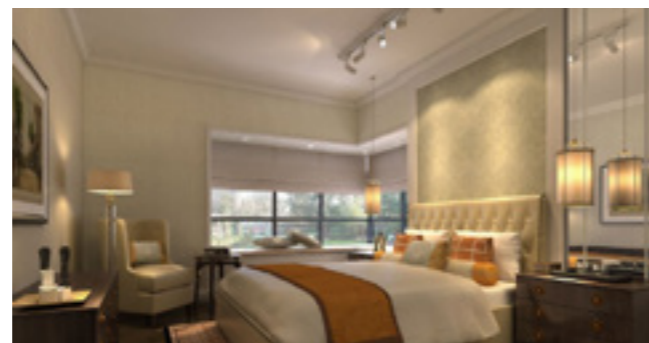

AVAILABLE FOR MULTIPLE MOUNTING STYLES



Versatile and Directional Track Lighting

Available in Any Situations Any Places

Form, Function and Flexibility for Architectural and Commercial Spaces

Liteharbor Your One-Stop Lighting Supplier, Quality & Services Assure!

Your Track Lighting Can Be Track Mounted

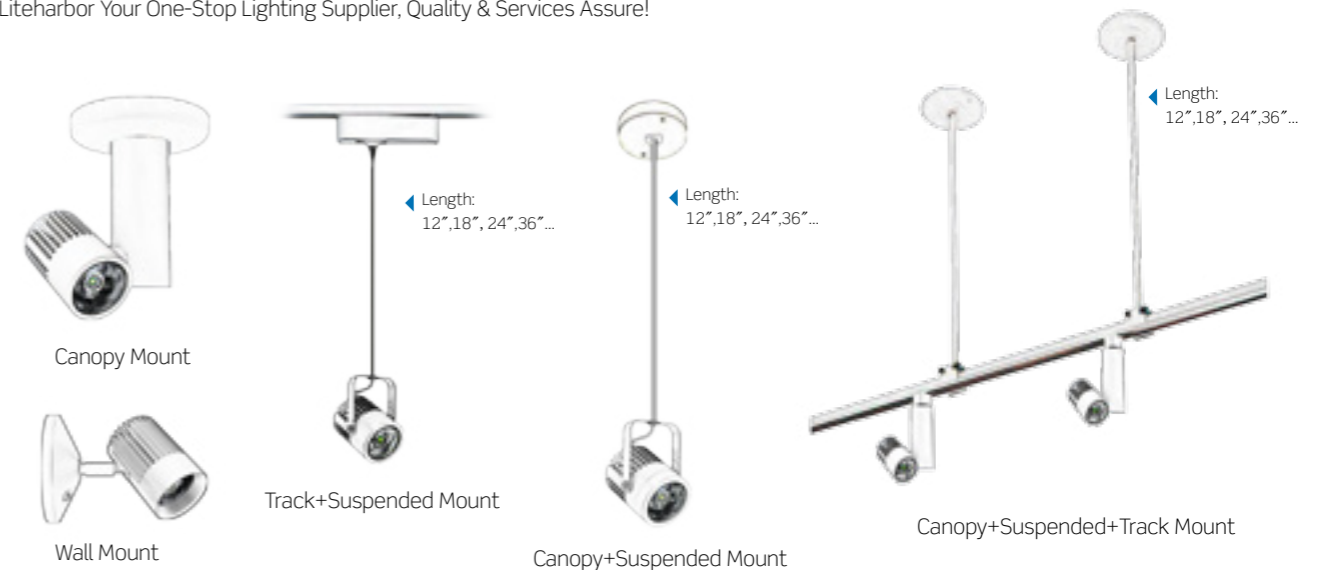

Tracks can be mounted to ceilings or walls, lengthwise down beams, or crosswise across rafters or joists, they can also be hung with rods from especially high places like vaulted ceilings, typical systems have line voltage running through a recessed track. Adjustability, bright light and modern look of track lights make them a particularly good-looking workhorse in contemporary spaces.

What amazing track lights they are- if you are looking for a reliable supplier, Liteharbor Lighting you really can't miss!



Complete selection of track connectors and accessories

10W LED COB TRACK LIGHT



LIGHT SOURCE
COB LED
K3023S

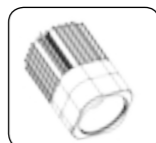

NEW PRODUCTS
COMING SOON

DESCRIPTION

Color Temperature 2700K-6000K
CRI 80+/90+
3 Step MacAdam (3 SDMC)
Passive aluminum heat sink
50,000 hrs average rated life

DIMMING

Track Dimming: (ELV) reverse phase control dimmers. 120V only.
Dimmable 100 - 10%

Canopy Dimming: ELV Dimming 120V

DRIVER

Track luminaire is designed for use with the following track systems

- Single Circuit/Single Neutral 120V
- Two Circuit/Single Neutral 120V
- Two Circuit / Two Neutral 120V
- Two Circuit / Two Neutral 277V

OPTICS

16° Spot, 24° Narrow Flood, 32° Flood, 50° Wide Flood

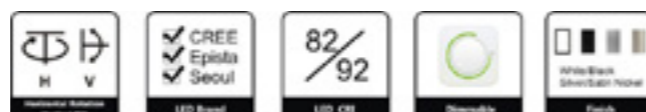

COB 10W = Halogen 50W

DIMENSIONS

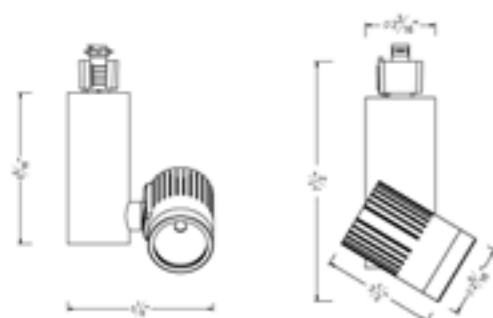

AVAILABLE FOR MULTIPLE MOUNTING STYLES



- a - Track Mount
- b - Canopy Mount
- c - Canopy+Suspended Mount
- d - Track+Suspended Mount
- e - Canopy+Suspended+Track Mount
- f - Wall Mount

ORDERING GUIDE / YOUR PRODUCT CODE

SERIES	BEAM SPREAD	POWER SUPPLY	CCT	LED AVAILABLE	FINISH
K3023S 10W COB Track Light	16° Spot	Non-Dimming 120V	2700K	Philips	White
	24° Narrow Flood	Non-Dimming 277V	3000K	Cree	Black
	32° Flood	ELV Dimming 120V	4000K	Epistar	Silver
	50° Wide Flood		5000K	Seoul	Satin Nickel
			6000K	Osram	

* Customized Also Available

LISTING / WARRANTY

ETL listed to US and Canadian standards for damp location W/Feed through.
5 Years Limited Warranty.

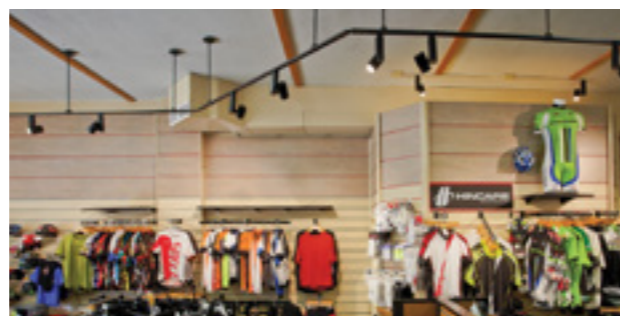

Liteharbor Harbor of Light!

24W LED COB TRACK LIGHT



LIGHT SOURCE
COB LED
K3023M

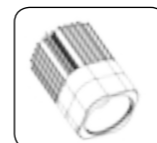

NEW PRODUCTS
COMING SOON

DESCRIPTION

Color Temperature 2700K-6000K
CRI 80+/90+
3 Step MacAdam (3 SDMC)
Passive aluminum heat sink
50,000 hrs average rated life

DIMMING

Track Dimming: (ELV) reverse phase control dimmers. 120V only.
Dimmable 100 - 10%

Canopy Dimming: ELV Dimming 120V

DRIVER

Track luminaire is designed for use with the following track systems

- Single Circuit/Single Neutral 120V
- Two Circuit/Single Neutral 120V
- Two Circuit / Two Neutral 120V
- Two Circuit / Two Neutral 277V

OPTICS

16° Spot, 24° Narrow Flood, 32° Flood, 50° Wide Flood

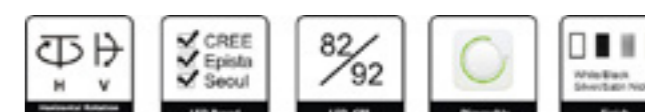

COB 24W = Halogen 120W

DIMENSIONS

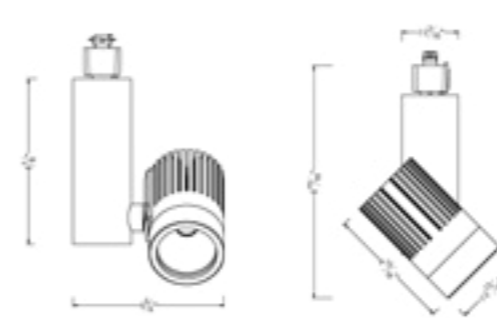

AVAILABLE FOR MULTIPLE MOUNTING STYLES

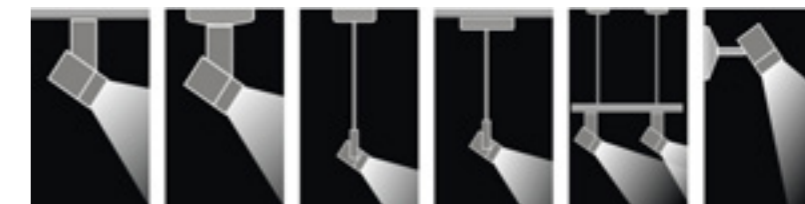

- a - Track Mount
- b - Canopy Mount
- c - Canopy+Suspended Mount
- d - Track+Suspended Mount
- e - Canopy+Suspended+Track Mount
- f - Wall Mount

ORDERING GUIDE / YOUR PRODUCT CODE

SERIES	BEAM SPREAD	POWER SUPPLY	CCT	LED AVAILABLE	FINISH
K3023M 24W COB Track Light	16° Spot	Non-Dimming 120V	2700K	Philips	White
	24° Narrow Flood	Non-Dimming 277V	3000K	Cree	Black
	32° Flood	ELV Dimming 120V	4000K	Epistar	Silver
	50° Wide Flood		5000K	Seoul	Satin Nickel
			6000K	Osram	

* Customized Also Available

LISTING / WARRANTY

ETL listed to US and Canadian standards for damp location W/Feed through.
5 Years Limited Warranty.



E-mail: info@liteharbor.com

2X24W DOUBLE HEAD LED COB TRACK LIGHT

LIGHT SOURCE
COB LED
K3023M2

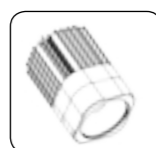

NEW PRODUCTS
COMING SOON

DESCRIPTION

Color Temperature 2700K-6000K
CRI 80+ /90+
3 Step MacAdam (3 SDMC)
Passive aluminum heat sink
50,000 hrs average rated life

DIMMING

Track Dimming: (ELV) reverse phase control dimmers. 120V only.
Dimmable 100 - 10%

Canopy Dimming: ELV Dimming 120V

DRIVER

Track luminaire is designed for use with the following track systems

- Single Circuit/Single Neutral 120V
- Two Circuit/Single Neutral 120V
- Two Circuit / Two Neutral 120V
- Two Circuit / Two Neutral 277V

OPTICS

16° Spot, 24° Narrow Flood, 32° Flood, 50° Wide Flood

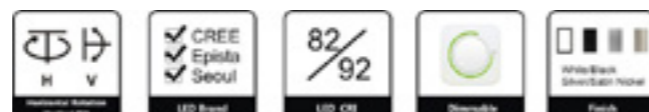

COB 2x24W = Halogen 2x120W

DIMENSIONS

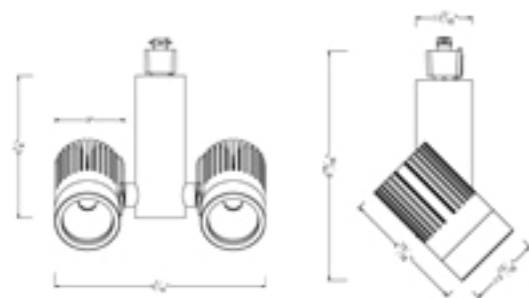

AVAILABLE FOR MULTIPLE MOUNTING STYLES

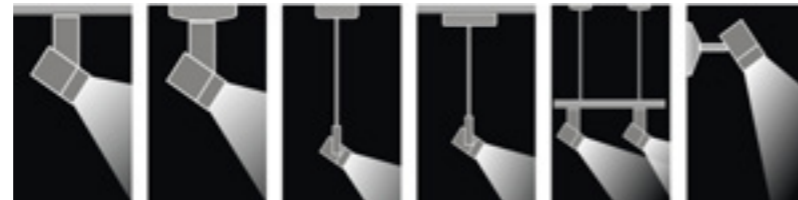

- a - Track Mount
b - Canopy Mount
c - Canopy+Suspended Mount
d - Track+Suspended Mount
e - Canopy+Suspended+Track Mount
f - Wall Mount

ORDERING GUIDE / YOUR PRODUCT CODE

SERIES	BEAM SPREAD	POWER SUPPLY	CCT	LED AVAILABLE	FINISH
○ K3023M2 2x24W COB Track Light	○ 16° Spot	○ Non-Dimming 120V	○ 2700K	○ Philips	○ White
	○ 24° Narrow Flood	○ Non-Dimming 277V	○ 3000K	○ Cree	○ Black
	○ 32° Flood	○ ELV Dimming 120V	○ 4000K	○ Epistar	○ Silver
	○ 50° Wide Flood		○ 5000K	○ Seoul	○ Satin Nickel
			○ 6000K	○ Osram	

* Customized Also Available

LISTING / WARRANTY

ETL listed to US and Canadian standards for damp location W/Feed through.
5 Years Limited Warranty.



Liteharbor Harbor of Light!

40W LED COB TRACK LIGHT

K3023L

LIGHT SOURCE
COB LED

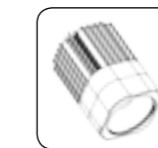

NEW PRODUCTS
COMING SOON

DESCRIPTION

Color Temperature 2700K-6000K
CRI 80+ /90+
3 Step MacAdam (3 SDMC)
Passive aluminum heat sink
50,000 hrs average rated life

DIMMING

Track Dimming: (ELV) reverse phase control dimmers. 120V only.
Dimmable 100 - 10%

Canopy Dimming: ELV Dimming 120V

DRIVER

Track luminaire is designed for use with the following track systems

- Single Circuit/Single Neutral 120V
- Two Circuit/Single Neutral 120V
- Two Circuit / Two Neutral 120V
- Two Circuit / Two Neutral 277V

OPTICS

16° Spot, 24° Narrow Flood, 32° Flood, 50° Wide Flood

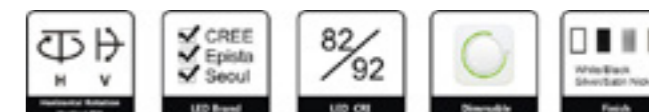

COB 40W = Halogen 200W

DIMENSIONS

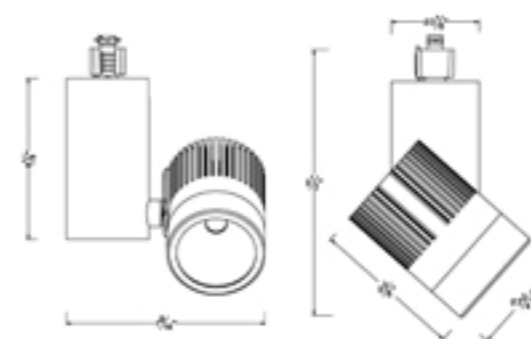

AVAILABLE FOR MULTIPLE MOUNTING STYLES



- a - Track Mount
b - Canopy Mount
c - Canopy+Suspended Mount
d - Track+Suspended Mount
e - Canopy+Suspended+Track Mount
f - Wall Mount

ORDERING GUIDE / YOUR PRODUCT CODE

SERIES	BEAM SPREAD	POWER SUPPLY	CCT	LED AVAILABLE	FINISH
○ K3023L 40W COB Track Light	○ 16° Spot	○ Non-Dimming 120V	○ 2700K	○ Philips	○ White
	○ 24° Narrow Flood	○ Non-Dimming 277V	○ 3000K	○ Cree	○ Black
	○ 32° Flood	○ ELV Dimming 120V	○ 4000K	○ Epistar	○ Silver
	○ 50° Wide Flood		○ 5000K	○ Seoul	○ Satin Nickel
			○ 6000K	○ Osram	

* Customized Also Available

LISTING / WARRANTY

ETL listed to US and Canadian standards for damp location W/Feed through.
5 Years Limited Warranty.



E-mail:info@liteharbor.com

FLUSH MOUNT VERTICAL LED COB TRACK LIGHT

LIGHT SOURCE
COB LED **FM3024**

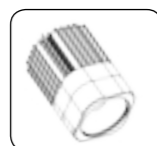

NEW PRODUCTS
COMING SOON

DESCRIPTION

Color Temperature 2700K-6000K
CRI 80+/90+
3 Step MacAdam (3 SDMC)
Passive aluminum heat sink
50,000 hrs average rated life

DIMMING

Track Dimming: (ELV) reverse phase control dimmers. 120V only.
Dimmable 100 - 10%

Canopy Dimming: ELV Dimming 120V

DRIVER

Track luminaire is designed for use with the following track systems

- Single Circuit/Single Neutral 120V
- Two Circuit/Single Neutral 120V
- Two Circuit / Two Neutral 120V
- Two Circuit / Two Neutral 277V

OPTICS

16° Spot, 24° Narrow Flood, 32° Flood, 50° Wide Flood

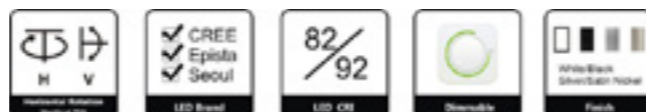

COB 30W = Halogen 150W

DIMENSIONS

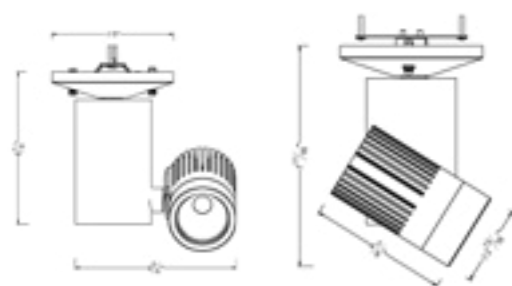

AVAILABLE FOR MULTIPLE MOUNTING STYLES



- a - Track Mount
- b - Canopy Mount
- c - Canopy+Suspended Mount
- d - Track+Suspended Mount
- e - Canopy+Suspended+Track Mount
- f - Wall Mount

ORDERING GUIDE / YOUR PRODUCT CODE

SERIES	BEAM SPREAD	POWER SUPPLY	CCT	LED AVAILABLE	FINISH
○ K3023S-30W 30W COB Track Light	○ 16° Spot ○ 24° Narrow Flood	○ Non-Dimming 120V ○ Non-Dimming 277V	○ 2700K ○ 3000K	○ Philips ○ Cree	○ White ○ Black
○ K3023S-32W 32W COB Track Light	○ 32° Flood ○ 50° Wide Flood	○ ELV Dimming 120V	○ 4000K ○ 5000K ○ 6000K	○ Epistar ○ Seoul ○ Osram	○ Silver ○ Satin Nickel

* Customized Also Available

LISTING / WARRANTY

ETL listed to US and Canadian standards for damp location W/Feed through.
5 Years Limited Warranty.



Liteharbor Harbor of Light!

FLUSH MOUNT HORIZONTAL LED COB TRACK LIGHT

LIGHT SOURCE
COB LED **FM3024A**

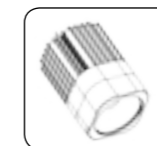

NEW PRODUCTS
COMING SOON

DESCRIPTION

Color Temperature 2700K-6000K
CRI 80+/90+
3 Step MacAdam (3 SDMC)
Passive aluminum heat sink
50,000 hrs average rated life

DIMMING

Track Dimming: (ELV) reverse phase control dimmers. 120V only.
Dimmable 100 - 10%

Canopy Dimming: ELV Dimming 120V

DRIVER

Track luminaire is designed for use with the following track systems

- Single Circuit/Single Neutral 120V
- Two Circuit/Single Neutral 120V
- Two Circuit / Two Neutral 120V
- Two Circuit / Two Neutral 277V

OPTICS

16° Spot, 24° Narrow Flood, 32° Flood, 50° Wide Flood



COB 32W = Halogen 160W

DIMENSIONS

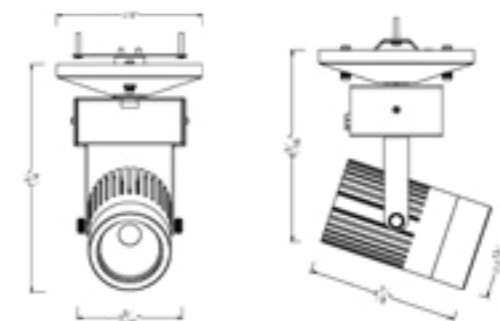

AVAILABLE FOR MULTIPLE MOUNTING STYLES



- a - Track Mount
- b - Canopy Mount
- c - Canopy+Suspended Mount
- d - Track+Suspended Mount
- e - Canopy+Suspended+Track Mount
- f - Wall Mount

ORDERING GUIDE / YOUR PRODUCT CODE

SERIES	BEAM SPREAD	POWER SUPPLY	CCT	LED AVAILABLE	FINISH
○ FM3024A-30W 30W COB Track Light	○ 16° Spot ○ 24° Narrow Flood	○ Non-Dimming 120V ○ Non-Dimming 277V	○ 2700K ○ 3000K	○ Philips ○ Cree	○ White ○ Black
○ FM3024A-32W 32W COB Track Light	○ 32° Flood ○ 50° Wide Flood	○ ELV Dimming 120V	○ 4000K ○ 5000K ○ 6000K	○ Epistar ○ Seoul ○ Osram	○ Silver ○ Satin Nickel

* Customized Also Available

LISTING / WARRANTY

ETL listed to US and Canadian standards for damp location W/Feed through.
5 Years Limited Warranty.



E-mail: info@liteharbor.com

AC MODE CEILING/WALL MOUNT COB TRACK LIGHT WITH NO DRIVER

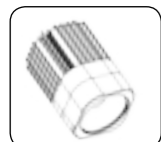

NEW PRODUCTS COMING SOON



FM3023M

DESCRIPTION

Color Temperature 2700K-6000K
CRI 80+/90+
3 Step MacAdam (3 SDMC)
Passive aluminum heat sink
50,000 hrs average rated life

DIMMING

Track Dimming: (ELV) reverse phase control dimmers. 120V only.
Dimmable 100 - 10%
Canopy Dimming: ELV Dimming 120V

DRIVER

Track luminaire is designed for use with the following track systems
- Single Circuit/Single Neutral 120V
- Two Circuit/Single Neutral 120V
- Two Circuit / Two Neutral 120V
- Two Circuit / Two Neutral 277V

OPTICS

16° Spot, 24° Narrow Flood, 32° Flood, 50° Wide Flood



COB 24W = Halogen 120W

DIMENSIONS

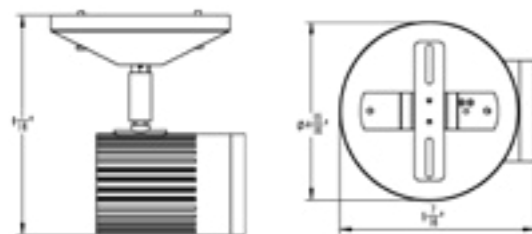

AVAILABLE FOR MULTIPLE MOUNTING STYLES



- a - Track Mount
- b - Canopy Mount
- c - Canopy+Suspended Mount
- d - Track+Suspended Mount
- e - Canopy+Suspended+Track Mount
- f - Wall Mount

ORDERING GUIDE / YOUR PRODUCT CODE

SERIES	BEAM SPREAD	POWER SUPPLY	CCT	LED AVAILABLE	FINISH
○ FM3023M 24W COB Track Light	○ 16° Spot ○ 24° Narrow Flood ○ 32° Flood ○ 50° Wide Flood	○ Non-Dimming 120V ○ Non-Dimming 277V ○ ELV Dimming 120V	○ 2700K ○ 3000K ○ 4000K ○ 5000K ○ 6000K	○ Philips ○ Cree ○ Epistar ○ Seoul ○ Osram	○ White ○ Black ○ Silver ○ Satin Nickel

* Customized Also Available

LISTING / WARRANTY

ETL listed to US and Canadian standards for damp location W/Feed through.
5 Years Limited Warranty.

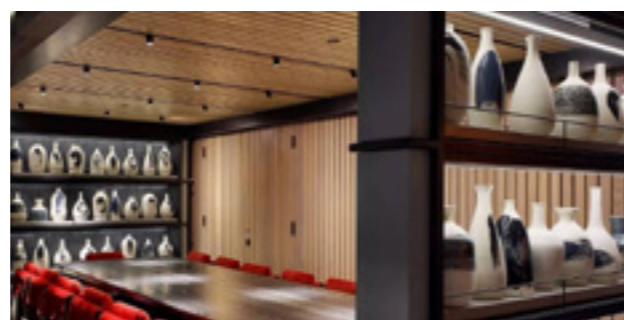

Liteharbor Harbor of Light!

MULTIPLE HEADS LED COB TRACK LIGHT WITH FIXED TRACK BAR



K3023-XC Series

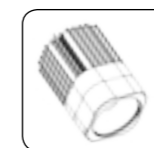

NEW PRODUCTS COMING SOON



COB 30W = Halogen 150W

Mounts to a standard 4" square or octagon junction box.

DESCRIPTION

Color Temperature 2700K-6000K
CRI 80+/90+
3 Step MacAdam (3 SDMC)
Passive aluminum heat sink
50,000 hrs average rated life

DIMMING

Track Dimming: (ELV) reverse phase control dimmers. 120V only.
Dimmable 100 - 10%
Canopy Dimming: ELV Dimming 120V

DRIVER

Track luminaire is designed for use with the following track systems
- Single Circuit/Single Neutral 120V
- Two Circuit/Single Neutral 120V (No Dimming)
- Two Circuit / Two Neutral 120V
- Two Circuit / Two Neutral 277V

OPTICS

16° Spot, 24° Narrow Flood, 32° Flood, 50° Wide Flood



DIMENSIONS

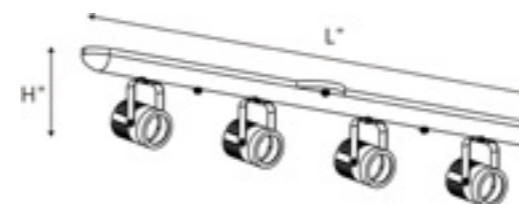

Lamp	1-Lamp	2-Lamp	3-Lamp	4-Lamp
Length (L)	4 15/16"	17 11/16"	25 3/16"	36"
Height (H)	6"	6"	6"	6"

AVAILABLE FOR MULTIPLE MOUNTING STYLES



- a - Track Mount
- b - Canopy Mount
- c - Canopy+Suspended Mount
- d - Track+Suspended Mount
- e - Canopy+Suspended+Track Mount
- f - Wall Mount

ORDERING GUIDE / YOUR PRODUCT CODE

SERIES	BEAM SPREAD	BEAM SPREAD	POWER SUPPLY	CCT	LED AVAILABLE	FINISH
○ K3023-1C ○ K3023-2C ○ K3023-3C ○ K3023-4C	○ 15W/Lamp ○ 25W/Lamp ○ 30W/Lamp	○ 16° Spot ○ 24° Narrow Flood ○ 32° Flood ○ 50° Wide Flood	○ Non-Dimming 120V ○ Non-Dimming 277V ○ ELV Dimming 120V	○ 2700K ○ 3000K ○ 4000K ○ 5000K ○ 6000K	○ Philips ○ Cree ○ Epistar ○ Seoul ○ Osram	○ White ○ Black ○ Silver ○ Satin Nickel

* Customized Also Available

LISTING / WARRANTY

ETL listed to US and Canadian standards for damp location W/Feed through.
5 Years Limited Warranty.



E-mail:info@liteharbor.com

LOW-VOLTAGE CENTRALIZED POWER SUPPLY LED TRACK LIGHT

K3023M-D



COB 15W = Halogen 75W

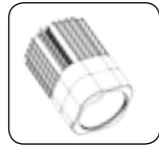

NEW PRODUCTS COMING SOON

FEATURES

Centrally powered driver 120V input to 42V low pressure output to track bar, then through a buck pcb at the light source becomes the output 36V power lamp beads. Low-voltage centralized power supply improves safety and reduces single lamp spare parts. The structure of the track lights is compact and the appearance is simple and generous. 15W per lamp, up to 9 lamp heads can be installed (8 foot track bar, others can be customized as required). The lighting has a wide range of adjustments, the horizontal adjustability is as high as 358°, and the vertical tunability is up to 90 degrees. It provides good light output, high efficiency and energy saving, and can be suitable for various lighting places. Long life, low electromagnetic interference, low energy consumption, high performance and provides short circuit and over current protection. Dimming: Non-Dimming/TRIAC Dimming, compatible with a variety of silicon controlled dimming, dimming depth 5% without flicker.

SPECIFICATIONS

Radiator: Using cold forging radiator, fast heat dissipation, he patented structure of the heat dissipation module, integrated balanced conduction convection, radiation heat, to ensure long product life.
 Lens: Professional optical grade PMMA lens, a variety of beam angles (narrow 10°, medium 20°, wide 30°) are available, and other beam angles are available.
 Spraying: Environmental protection electrostatic powder coating surface treatment process, durable wear.

Mounts to a standard 4" square or octagon junction box.

APPLICATIONS

Apply to automotive and parking, education, government, healthcare, hospitality, offices and banks, religious, retail.



DIMENSIONS



AVAILABLE FOR MULTIPLE MOUNTING STYLES



- a - Track Mount
- b - Canopy Mount
- c - Canopy+Suspended Mount
- d - Track+Suspended Mount
- e - Canopy+Suspended+Track Mount
- f - Wall Mount

ORDERING GUIDE / YOUR PRODUCT CODE

SERIES	LUMEN	CCT	CRI	DIMMING
○ K3023M-D	○ 1120lm/lamp	○ 2700K	○ 80+	○ Non-Dimming
Low-voltage Centralized Power Supply LED Track Light		○ 3000K	○ 90+	○ TRIAC Dimming
		○ 4000K		
		○ 5000K		
		○ 6000K		

* Customized Also Available

LISTING / WARRANTY

ETL listed to US and Canadian standards for damp location W/Feed through. 5 Years Limited Warranty.

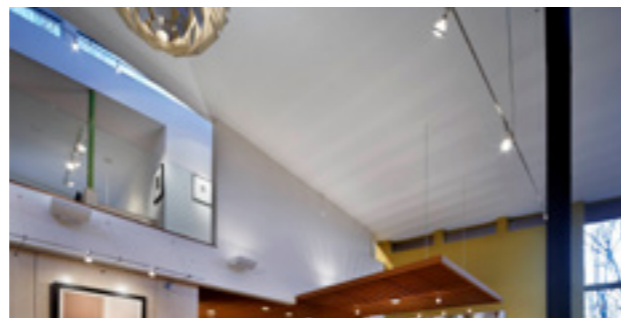

Liteharbor Harbor of Light!

CANOPY+SUSPENDED MOUNT COB LED TRACK LIGHT

K3033-XC Series

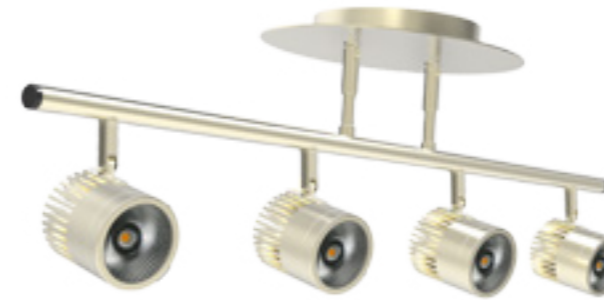

COB 30W = Halogen 150W

Mounts to a standard 4" square or octagon junction box.

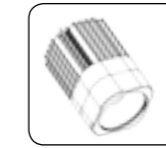

NEW PRODUCTS COMING SOON

DESCRIPTION

Color Temperature 2700K-6000K
 CRI 80+/90+
 3 Step MacAdam(3 SDMC)
 Passive aluminum heat sink
 50,000 hrs average rated life

DIMMING

Track Dimming: (ELV) reverse phase control dimmers. 120V only. Dimmable 100 - 10%
 Canopy Dimming: ELV Dimming 120V

DRIVER

Track luminaire is designed for use with the following track systems
 - Single Circuit/Single Neutral 120V
 - Two Circuit/Single Neutral 120V (No Dimming)
 - Two Circuit / Two Neutral 120V
 - Two Circuit / Two Neutral 277V

OPTICS

16° Spot, 24° Narrow Flood, 32° Flood, 50° Wide Flood



DIMENSIONS

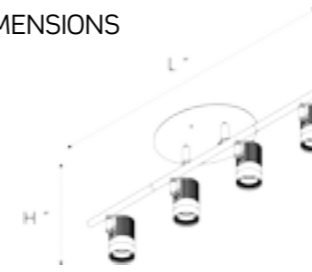

Lamp	1-Lamp	2-Lamp	3-Lamp	4-Lamp
Length (L)	5"	15 3/4"	26"	35 7/16"
Height (H)	4 7/16"	8 1/8"	8 1/8"	8 1/8"

AVAILABLE FOR MULTIPLE MOUNTING STYLES



- a - Track Mount
- b - Canopy Mount
- c - Canopy+Suspended Mount
- d - Track+Suspended Mount
- e - Canopy+Suspended+Track Mount
- f - Wall Mount

ORDERING GUIDE / YOUR PRODUCT CODE

SERIES	BEAM SPREAD	BEAM SPREAD	POWER SUPPLY	CCT	LED AVAILABLE	FINISH
○ K3033-1C	○ 15W/Lamp	○ 16° Spot	○ Non-Dimming 120V	○ 2700K	○ Philips	○ White
○ K3033-2C	○ 25W/Lamp	○ 24° Narrow Flood	○ Non-Dimming 277V	○ 3000K	○ Cree	○ Black
○ K3033-3C	○ 30W/Lamp	○ 32° Flood	○ ELV Dimming 120V	○ 4000K	○ Epistar	○ Silver
○ K3033-4C		○ 50° Wide Flood		○ 5000K	○ Seoul	○ Satin Nickel
				○ 6000K	○ Osram	

* Customized Also Available

LISTING / WARRANTY

ETL listed to US and Canadian standards for damp location W/Feed through. 5 Years Limited Warranty.



E-mail:info@liteharbor.com

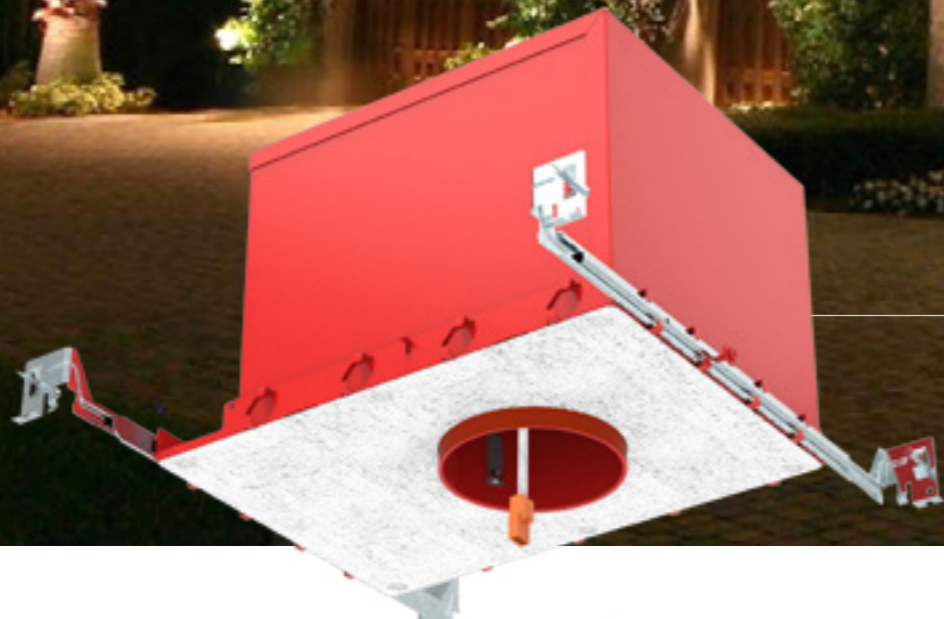

HIGH-END DIE-CASTING NEW CONSTRUCTION FIRE RATED IC AIRTIGHT LED DOWNLIGHT HOUSING

Specification grade fire-rated new construction housing. The double wall fixture incorporates a non-combustible fiber insulation to prevent passage of flames, toxic gases, ignitable gasses into ceiling plenums.



Liteharbor Lighting Fire-Rated Downlight is fully-assembled, easy to install, and lightweight (installers can easily carry six-packs into and throughout any job-site). Our fire rated downlight housing is designed to meet today's one or two-hour fire-rated IC & Non-IC codes for high-rise condominiums, apartment buildings, multi-family residences, hotels, hospitalities, assisted living homes, health care and hospitals. Don't take chances with the lives of your residents, guests, or tenants in any multi-story environment. Use Liteharbor fire rated downlight now to insure safety and save lives.

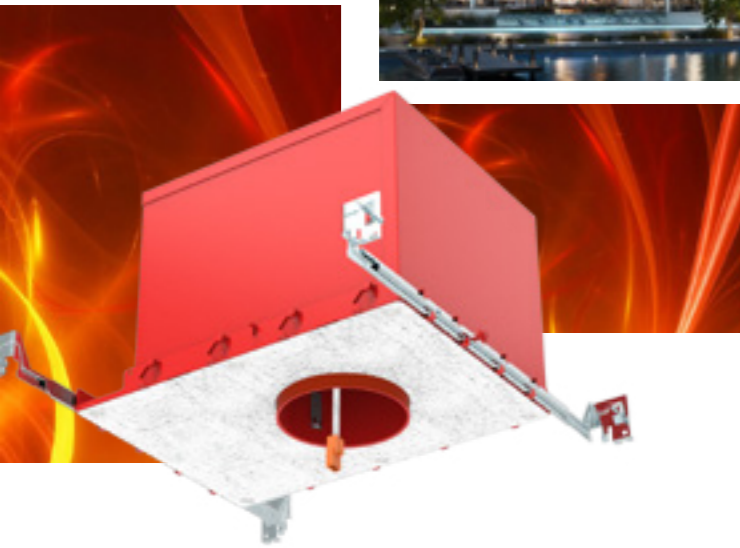

FIRE-RATED RECESSED LIGHTING SOLUTION AT ITS BEST

The assemblies in which it is approved for use without any additional installation effort. The effort necessary to install the Liteharbor Luminaire is comparable to the effort required to install a standard recessed light fixture. When a standard recessed light fixture is installed through the membrane of a fire resistance rated floor/ceiling or roof/ceiling assembly, additional measures must be taken to ensure that the integrity of the fire resistance rated assembly is maintained. This protection typically involves the construction of a 5-sided gypsum board enclosure behind/around the recessed fixture. The construction of these enclosures is often cumbersome and requires coordination between the drywall contractor and the electrician. The depth of the floor/ceiling system must sometimes be adjusted to accommodate the construction of these additional enclosure. The extra time and labor effort to construct enclosures at all recessed light fixtures throughout an entire project can be avoided by the use of the Liteharbor Luminaire.

Liteharbor Lighting's ground-breaking fire rated downlight design will stop the transfer of flames and heat. Our product will help contain fire for one or two hours, based on installation type and ceiling design. As easy to install as any standard recessed housing, Liteharbor fire rated downlight lets you leave all additional joint tape, hats, gaskets, other hardware, and caulk behind.

2-HOUR FIRE-RATED RECESSED LIGHTING LUMINAIRE





REST EASY WITH FIRE RATED DOWNLIGHT

www.liteharbor.com

Liteharbor's patent-pending technology responds immediately to rising temperatures by expanding up to eighty times without compromise or constraint. It is designed to completely seal the back of the can and ensure that heat and flames will not transfer through the ceiling and move to the next floor or other rooms. Available with an LED, Compact Fluorescent, or Incandescent light source. Manufactured with ultra lightweight materials, it is the newest and best application for any environment where safety is paramount. Fire resistance rated construction is required by the IBC for a variety of different situations. Occupancy that include residential type sleeping accommodations (Use Groups R-1, R-2, R-3, R-4 & I-1) are always required to be provided with fire resistance rated separations between individual dwelling/sleeping units.

Four different apertures:

3^{INCH}

Aperture

4^{INCH}

Aperture

5^{INCH}

Aperture

6^{INCH}

Aperture



SAVING TIME

Fire rated downlight is a self-contained 1 or 2 Hour Fire-Rated Luminaire. Factory manufactured, is tested at Intertek Testing Services in accordance with ASTM E119 for typical multi-family unit drywall ceilings, wood joists, and deck assembly construction.



ENERGY STAR

Fixture is compatible with Elite Lighting Energy Star listed retrofit LEDs and self-ballast fluorescent lamps. Consult The Energy Star website for the most updated list of qualified lights.

What Is A Fire Rated Downlight?

When faced with the task of choosing recessed downlights for your home or business, one of the first questions you maybe asked is; do you want fire rated on non-fire rated downlights?

When a hole is cut into a ceiling to mount a recessed downlight into, a potential fire hazard is created. Plaster board ceilings (for example) have a natural ability to act as a fire barrier. In any building where people maybe living or inhabiting above, the ceiling below must be fire rated. Fire rated downlights are used to restore the fire integrity of a ceiling.

In the event of a fire, the downlight hole is like a gateway that allows fire to spread through, unchallenged. Once the fire starts to spread through this hole it has direct access to the adjoining structure, usually made from wooden ceiling joists. Fire rated downlights seal off the hole and slow down the spread of fire. Modern fire rated downlights are fitted with an intumescent pad which swells up when it reaches a certain temperature and blocks the spread of fire. The fire then has to find another way around - delaying its progress.

This delay allows occupants to escape the building or ideally allows additional time for the fire to be extinguished. You will notice that some fire rated downlights are rated at 30, 60 or 90 minutes. This rating depends on the structure of the building and more importantly how many floors it has. The top floor of a block of flats for example would require a 90 or possibly 120 minute fire rating, whilst a ceiling in the bottom floor of a house would be 30 or 60 minutes.

If you cut into a ceiling you must restore it to its original condition and not interfere with its natural ability to act as a fire barrier. Surface mounted downlights don't need a fire rating, only recessed downlights have this requirement.

Does Every Downlight Have To Be Fire Rated?

Downlights should be fire rated to protect people on the floors above and aid evacuation. Slowing the spread of fire makes escape easier for all concerned and reduces risk of harm from falling debris.

You can use a standard downlight with a fire hood, but this often ends up being more expensive.

The Electrical Safety Council (ESC) recommends that fire rated options should be used in all buildings even though fire resistant downlights aren't legally needed under a roof void (e.g. An empty loft).

LITEHARBOR PRODUCT SPECIFICATIONS

FEATURES

- 1-hour or 2-hour fire-rated recessed luminaire
- 1 recessed Lighting Luminaire conforms to 2-hour fire rating
- Prevents flames and smoke from passing through the light fixture and spreading throughout floor above
- Available in a 3", 4", 5", and 6" aperture
- Available in a LED, CFL, and INCANDESCENT light sources

BENEFITS

- Liteharbor recessed lighting luminaire offers new alternatives on achieving fire rating on commercial and residential constructions
- Liteharbor recessed lighting luminaire can be used in either 1-hour and 2-hour floor to ceiling assembly
- Liteharbor recessed lighting luminaire eliminates the use of subcontractors to build additional boxes around a luminaire to achieve a 1-hour or 2-hour fire rating
- Liteharbor recessed lighting luminaire saves on construction time and the fire rating inspection process
- No modification required, will fit where any recessed lighting luminaire can be installed
- Liteharbor recessed lighting luminaire requires no additional parts – such as mineral fiber hats, steel enclosure boxes, or tape, in order to accomplish a 1-hour or 2-hour fire rating
- Liteharbor recessed lighting luminaire saves overall construction cost by allowing the building to be designed with 2" x 8" joist construction

RECESSED LIGHTING LUMINAIRE CONFORMS TO ASTM STD 119

2-HOUR FIRE-RATED

Fire-rated floor/ceiling assembly refer to UL Design No. L505

LISTING

- ITS/ETL rated recessed luminaire is 1-HOUR FIRE-RATED for fire-rated floor/ceiling assembly refer to UL Design No. L500 & P500 and 2-HOUR FIRE-RATED for fire-rated floor/ceiling assembly refer to UL Design No. L505
- Housing is IC-rated for direct contact with insulation and can be used in IC and Non-IC applications. Designed to be installed in 2" x 8" joist construction

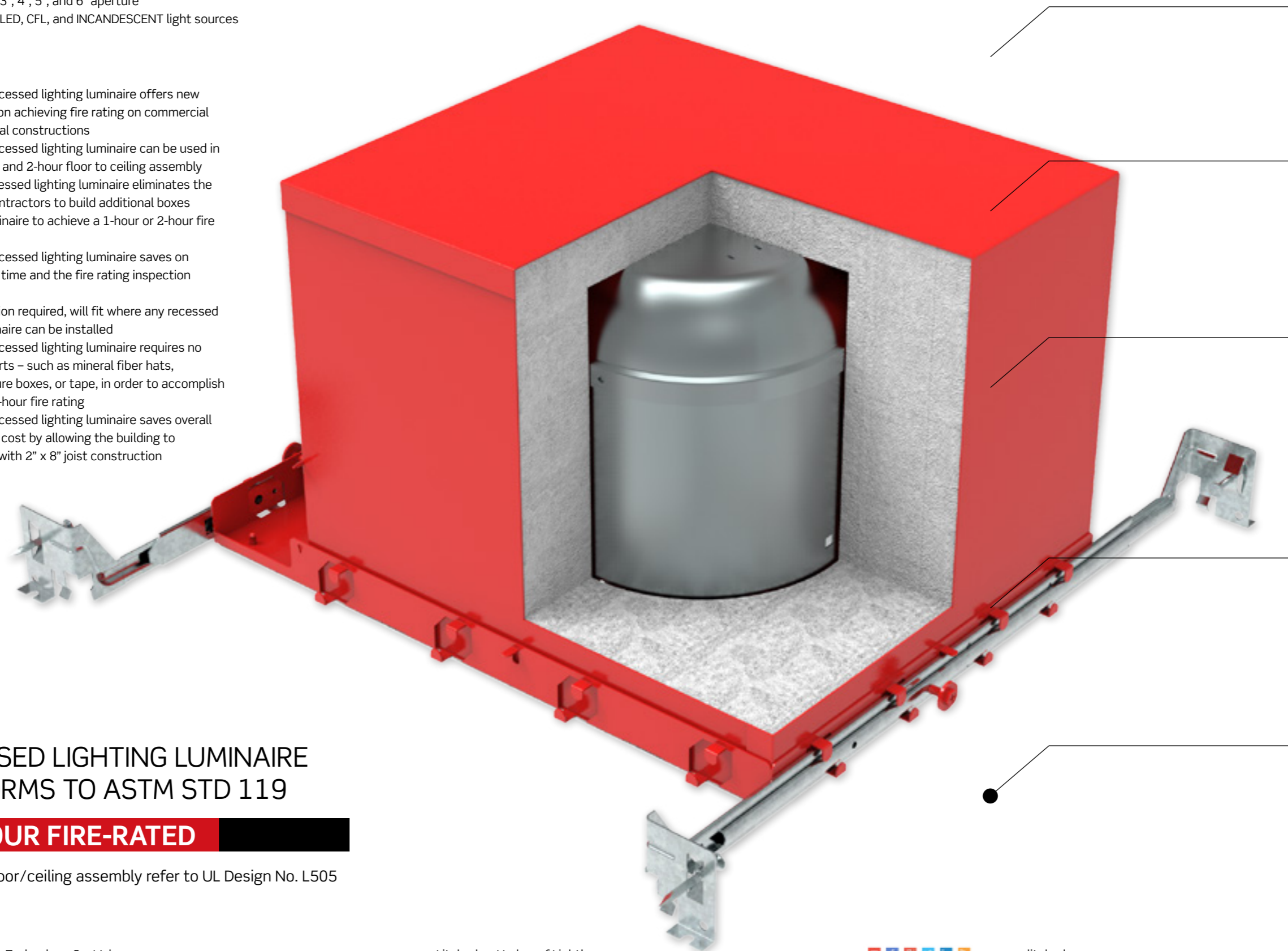

HOUSING

High temperature painted 22 gauge cold-rolled steel construction for maximum heat dissipation and rust protection.

CEILING THICKNESSES

Adjusts vertically in plaster frame to accommodate 1/2" to 1 -3/4" ceiling. This includes ceiling constructions of all 1 hour and 2 hour fire-rated assemblies.

BAR HANGERS

Preinstalled bar hangers allow housing to be positioned and locked at any point within a 24" joist span. They can be positioned on either the long or short axis of the housing and contain a double-headed nail for secure attachment to the joists.

SEALS FROM THE INSIDE OUT

The inner assembly reacts strongly to high temperatures (428°F/220°C and above) and swells to a solid dense mass filling the entire luminaire cavity.

FIRE PROTECTION PERFORMANCE

As the fire intensifies, a protection disk seals off the bottom opening of the housing and stops the fire from passing through the fixture.

SAVE CONSTRUCTION COSTS BY REDUCING LABOR AND COMPLETING CONSTRUCTION FASTER

REDUCED TOTAL CONSTRUCTION COST BY REDUCING WOOD/FLOOR FRAMING SYSTEM COST

FIRE SHIELD BENEFITS

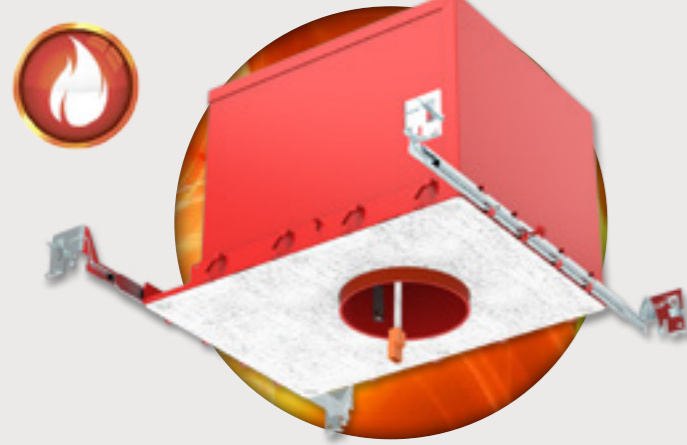

PLACING A FIRE-RATED ENCLOSURE COVER ON TOP OF A RECESSED HOUSING



INSTALLING A DRYWALL BOX AROUND A RECESSED HOUSING



INSTALLING A METAL BOX AROUND A RECESSED HOUSING



✓ **The Liteharbor Luminaire can help to simplify the design and construction of membrane-protected fire resistance rated floor/ceiling and roof/ceiling assemblies in a number of different occupancy and construction types.**

✓ Once Liteharbor recessed luminaire is installed, nothing else is required.

✓ Liteharbor recessed luminaire can be used in either a 1 hour or 2 hour floor to ceiling assembly.

✓ Liteharbor recessed luminaire housings can be installed in close proximity to each other and to the wall in order to get desired lighting effects, thus design is not limited because of the housing size and/or Fire-rated box sizes.

✓ Liteharbor recessed luminaire is IC rated for direct contact with insulation and can be used in IC and Non-IC applications, and does not require any additional clearance. May be installed in 2" x 8" joist construction, resulting in cost savings of up to 52% in wood joist construction costs.

✓ Pre installed bar hangers allow housing to be positioned and locked at any point within a 24" joist span.

✓ No other materials required.

✓ ETL listed for through-branch circuit wiring and designed, for straight through conduit runs.

When using the fire-rated recessed enclosure, recessed housing must be installed first. Once the recessed housing is installed and electrical inspection has passed, then an additional fire-rated enclosure needs to be installed on top of the existing recessed housing to convert to a fire rating, causing additional labor, material costs, and a delay in final inspection of electrical work for recessed lighting installation.

The type of fire-rated enclosure is different for a 1-hour or 2-hour fire rating.

Due to the size of the enclosure, housings cannot be installed in close proximity to each other and cannot be installed close to the wall. They can only be installed in the long axis, limiting the desired lighting effects and requiring additional clearance.

Installing a fire-rated enclosure on top of a recessed light requires additional space, therefore, not allowing standard 2" x 8" wood joist construction and requiring larger joist construction such as 2" x 10" or 2" x 12", which increases the cost of wood joist construction by 35-52%.

Using a fire-rated recessed enclosure risks movement and misplacement in the course of construction.

Requires additional materials, such as caulk, gaskets, and joint tape.

Additional costs and labor is required when daisy chaining and connecting one fixture to another.

When using the fire-rated recessed enclosure, recessed housing must be installed first. Once the recessed housing is installed and electrical inspection has passed, then the additional drywall subcontractors must build a fire-rated enclosure out of drywall around the existing recessed housing to convert to a fire-rated recessed luminaire, causing additional labor, material costs and a delay in final inspection of electrical work for recessed lighting installation.

The amount of layers of the drywall box depends on a 1-hour or 2-hour fire rating.

Due to the size of the enclosure, housings cannot be installed in close proximity to each other and cannot be installed close to the wall. They can only be installed in the long axis, limiting the desired lighting effects and requiring additional clearance.

Installing a fire-rated drywall box on top of a recessed light requires additional space, therefore, not allowing standard 2" x 8" wood joist construction, and requiring larger joist construction such as 2" x 10" or 2" x 12", which increases the cost of wood joist construction by 35-52%.

Requires multiple subcontractors, resulting in added labor costs and potential scheduling conflicts.

Requires additional materials, such as caulk, gaskets, and joint tape.

Additional costs and labor is required when daisy chaining and connecting one fixture to another.

When using the fire-rated recessed enclosure, recessed housing must be installed first. Once the recessed housing is installed and electrical inspection has passed, then an additional fire-rated enclosure needs to be installed on top of the existing recessed housing to convert to a fire rating, causing additional labor, material costs, and a delay in final inspection of electrical work for recessed lighting installation.

Only available for 1 hour fire-rating

Due to the size of the enclosure, housings cannot be installed in close proximity to each other and cannot be installed close to the wall. They can only be installed in the long axis, limiting the desired lighting effects and requiring additional clearance.

Installing a fire-rated metal enclosure on top of a recessed light requires additional space, therefore, not allowing standard 2" x 8" wood joist construction, and requiring larger joist construction such as 2" x 10" or 2" x 12", which increases the cost of wood joist construction by 35-52%.

Using a fire-rated recessed enclosure risks movement and misplacement in the course of construction.

Requires additional materials, such as caulk, gaskets, and joint tape.

Additional costs and labor required when daisy chaining and connecting one fixture to another.

3" NEW CONSTRUCTION FIRE & SOUND RATED IC AIRTIGHT DOWNLIGHT HOUSING

A3-IA-F

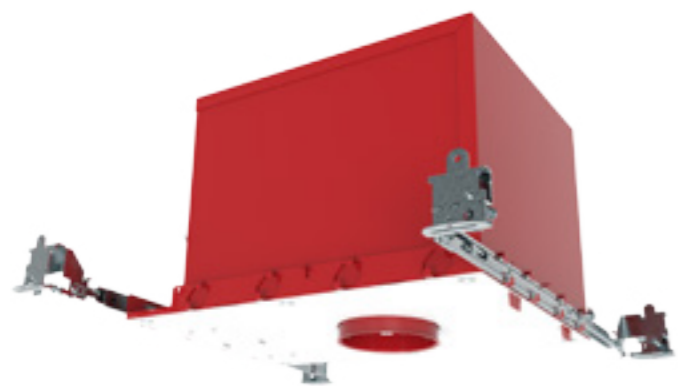

Retrofit Type	Voltage	Frequency	Dimming
GU10 Bulb	120V AC/ 277V AC	50/60 Hz	TRIAC/ ELV/ NONE
MR16 Bulb			
PAR16 Bulb			

*Please contact Liteharbor for details.

DIMENSIONS

L: 12 19/32"
W: 9 1/16"
H: 7 3/4"
a: 3 7/32"

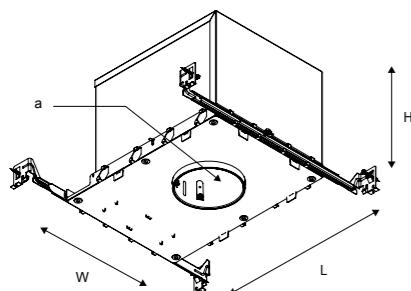

DESIGNED FOR 2" X 8" JOIST CONSTRUCTION

DESCRIPTION

This is a 3" fire and sound rated downlight housing, suitable for a variety of light such as LEDs and incandescent, it can be fitted to a wide range of 3 inch retrofit stands. Specification grade fire-rated new construction housing. The double wall fixture incorporates a non-combustible fiber insulation to prevent passage of flames, toxic gases, ignitable gasses into ceiling plenums. The ETL listed housing is rated for a minimum of 2 hours protection. The noncombustible fiber fill also acts as sound deadening material eliminating the transfer of sound between floors. Suitable for commercial, multi-family and residential applications. Ceiling thickness: 1/2" up to 1 1/4". Suitable for wet locations.

HOUSING

Fire and sound rated housing, Up to 120 minute fire rated L500 (floor-ceiling) & P500 (roof-ceiling) design. Die formed cool steel construction. Snap on cool steel cover. Non-combustible matt insulation.

JUNCTION BOX

4 in 4 out galvanized steel junction box.

BAR HANGER

Pre-installed adjustable bar hangers engineered to accommodate lumber, laminated beams and T-bar.

APPLICATIONS

Apply to automotive and parking, education, government, healthcare, hospitality, offices and banks, religious, retail. Especially in areas with limited ventilation, such as closets and utility rooms.

LISTING/ WARRANTY

ETL listed to US and Canadian standards for damp location W/Feed through. IC rated, Title 24 compliant, up to 2hour fire rated. 3 Year Limited Warranty.



3" NEW CONSTRUCTION FIRE & SOUND RATED IC AIRTIGHT DOWNLIGHT HOUSING



Fire and sound rated housing, Up to 120 minute fire rated L500 (floor-ceiling) & P500 (roof-ceiling) design. Die formed cool steel construction. Snap on cool steel cover.

· B3001 · B3002 · B3006 · B3007 · B3802 · B3008 · BS3002
· B3011 · BS3001 · BS3007

For more choice, please contact us.



B3002



B3006



B3007



B3011



FLUSH MOUNT



HOUSING ORDERING GUIDE / YOUR PRODUCT CODE

SERIES	CONSTRUCTION	FIRE RATING	WIRING TYPE
<input type="radio"/> A3-IA-F Fire rated Downlight Housing	<input type="radio"/> New Construction	<input type="radio"/> 2 Hours	<input type="radio"/> GU10 Socket <input type="radio"/> GU5.3 Socket <input type="radio"/> E26 Socket

LIGHT SOURCE ORDERING GUIDE / YOUR PRODUCT CODE

RETROFIT	CRI	FINISH	DIMMING
<input type="radio"/> GU10 Bulb <input type="radio"/> MR16 Bulb <input type="radio"/> PAR16 Bulb	<input type="radio"/> 80+ <input type="radio"/> 90+	<input type="radio"/> White <input type="radio"/> Black <input type="radio"/> Satin Nickel	<input type="radio"/> Non-Dimming <input type="radio"/> TRIAC <input type="radio"/> ELV

* Customized Also Available

4" NEW CONSTRUCTION FIRE RATED IC AIRTIGHT DOWNLIGHT HOUSING

A4-IA-F

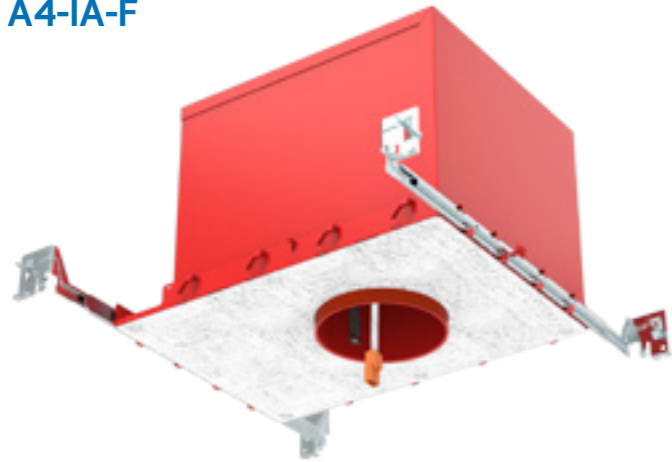

Retrofit Type	Voltage	Frequency	Dimming
4" Retrofit	120V AC/ 277V AC	50/60 Hz	TRIAC/ ELV/ NONE
GU10 Bulb			
MR16 Bulb			
PAR16/20 Bulb			

*Please contact Liteharbor for details.

DIMENSIONS

- L: 15 5/16"
- W: 9 1/16"
- H: 7 3/4"
- a: 4 5/16"

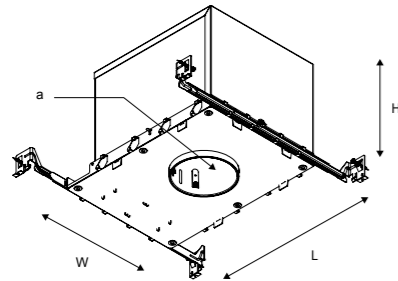

DESIGNED FOR 2" X 8" JOIST CONSTRUCTION

DESCRIPTION

This is a 4" fire and sound rated downlight housing, suitable for a variety of light sources such as LEDs and incandescent, it can be fitted to a wide range of 4 inch retrofit stands. Specification grade fire-rated new construction housing. The double wall fixture incorporates a non-combustible fiber insulation to prevent passage of flames, toxic gases, ignitable gasses into ceiling plenums. The cULus listed housing is rated for a minimum of 2 hours protection. The noncombustible fiber fill also acts as sound deadening material eliminating the transfer of sound between floors. Suitable for commercial, multi-family and residential applications. Ceiling thickness: 1/2" up to 1 1/4". Suitable for wet locations.

HOUSING

Fire and sound rated housing, Up to 120 minute fire rated L500 (floor-ceiling) & P500 (roof-ceiling) design. Die formed cool steel construction. Snap on cool steel cover. Non-combustible matt insulation.

JUNCTION BOX

4 in 4 out galvanized steel junction box.

BAR HANGER

Pre-installed adjustable bar hangers engineered to accommodate lumber, laminated beams and T-bar.

APPLICATIONS

Apply to automotive and parking, education, government, healthcare, hospitality, offices and banks, religious, retail. Especially in areas with limited ventilation, such as closets and utility rooms.

LISTING/ WARRANTY

UL listed to US and Canadian standards for damp location W/Feed through. IC rated, Title 24 compliant, UL 263 certificated up to 2 hour fire rated. 3 Year LED Limited Warranty



HOUSING ORDERING GUIDE / YOUR PRODUCT CODE

SERIES	CONSTRUCTION	FIRE RATING	WIRING TYPE
<input type="radio"/> A4-IA-F Fire rated Downlight Housing	<input type="radio"/> New Construction	<input type="radio"/> 2 Hours	<input type="radio"/> Fast connection terminal <input type="radio"/> GU10 Socket <input type="radio"/> GU5.3 Socket <input type="radio"/> E26 Socket

LIGHT SOURCE ORDERING GUIDE / YOUR PRODUCT CODE

RETROFIT	LUMEN	CRI	FINISH	DIMMING
<input type="radio"/> 4" Retrofit	<input type="radio"/> 750lm	<input type="radio"/> 80+	<input type="radio"/> White	<input type="radio"/> Non-Dimming
<input type="radio"/> GU10 Bulb	<input type="radio"/> 650lm	<input type="radio"/> 90+	<input type="radio"/> Black	<input type="radio"/> TRIAC
<input type="radio"/> MR16 Bulb			<input type="radio"/> Satin Nickel	<input type="radio"/> ELV
<input type="radio"/> PAR16/20 Bulb				

* Customized Also Available

4" NEW CONSTRUCTION FIRE RATED IC AIRTIGHT DOWNLIGHT HOUSING



4" Retrofit

Fire and sound rated housing, Up to 120 minute fire rated L500 (floor-ceiling) & P500 (roof-ceiling) design. Die formed cool steel construction. Snap on cool steel cover.

- BL4-001
- BSL4-001
- BL4-001-1
- BL4-001-E
- BL4-001-E
- BL4-002
- BL4-003
- BAL4-001
- BEL4-001
- BWL4-001
- BRL4-001-SF
- BRL4-002-SF



4" Trim (GU10 Bulb/MR16 Bulb/PAR16/20 Bulb)

Fire and sound rated housing, Up to 120 minute fire rated L500 (floor-ceiling) & P500 (roof-ceiling) design. Die formed cool steel construction. Snap on cool steel cover.

- B4001
- B4002
- B4003
- B4007
- B4012
- B4301
- ...
- BD4001
- BD4002
- BD4003
- BD4004
- BD4005
- BD4007
- ...
- BS4001
- BS4002
- BS4007
- BS4301
- BS4302
- BS4401
- ...
- BDS4001
- BDS4002
- BDS4007
- BDS4301
- BDS4302
- BDS4401
- ...

For more choice, please contact us.



FLUSH MOUNT



5" NEW CONSTRUCTION FIRE RATED IC AIRTIGHT DOWNLIGHT HOUSING

A5-IA-F

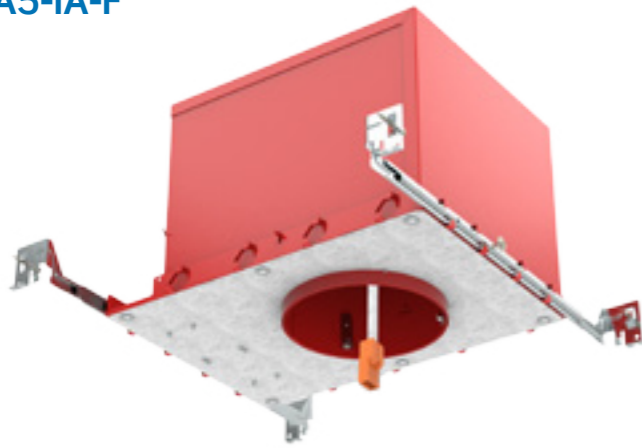

Retrofit Type	Voltage	Frequency	Dimming
5" Retrofit	120V AC/ 277V AC	50/60 Hz	TRIAC/ ELV/ NONE
PAR30 Bulb			

*Please contact Liteharbor for details.

DIMENSIONS

- L: 12 5/8"
- W: 9 1/16"
- H: 7 3/4"
- a: 5"

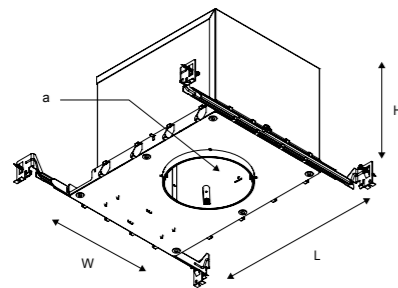

DESIGNED FOR 2" X 8" JOIST CONSTRUCTION

DESCRIPTION

This is a 5" fire and sound rated downlight housing, suitable for a variety of light sources such as LEDs and incandescent, it can be fitted to a wide range of 5 inch retrofit stands. Specification grade fire-rated new construction housing. The double wall fixture incorporates a non-combustible fiber insulation to prevent passage of flames, toxic gases, ignitable gasses into ceiling plenums. The cULus listed housing is rated for a minimum of 2 hours protection. The noncombustible fiber fill also acts as sound deadening material eliminating the transfer of sound between floors. Suitable for commercial, multi-family and residential applications. Ceiling thickness: 1/2" up to 1 1/4". Suitable for wet locations.

HOUSING

Fire and sound rated housing, Up to 120 minute fire rated L500 (floor-ceiling) & P500 (roof-ceiling) design. Die formed cool steel construction. Snap on cool steel cover. Non-combustible matt insulation.

JUNCTION BOX

4 in 4 out galvanized steel junction box.

BAR HANGER

Pre-installed adjustable bar hangers engineered to accommodate lumber, laminated beams and T-bar.

APPLICATIONS

Apply to automotive and parking, education, government, healthcare, hospitality, offices and banks, religious, retail. Especially in areas with limited ventilation, such as closets and utility rooms.

LISTING/ WARRANTY

UL listed to US and Canadian standards for damp location W/Feed through. IC rated, Title 24 compliant, UL 263 certificated up to 2 hour fire rated. 3 Year LED Limited Warranty



5" NEW CONSTRUCTION FIRE RATED IC AIRTIGHT DOWNLIGHT HOUSING



5" Retrofit

Fire and sound rated housing, Up to 120 minute fire rated L500 (floor-ceiling) & P500 (roof-ceiling) design. Die formed cool steel construction. Snap on cool steel cover.

- BL5-003



5" Trim (PAR30 Bulb)

Fire and sound rated housing, Up to 120 minute fire rated L500 (floor-ceiling) & P500 (roof-ceiling) design. Die formed cool steel construction. Snap on cool steel cover.

- B5001
- B5002
- B5003
- B5003L
- B5007
- B5011
- B5011K
- B5021
- B5022
- B5300
- B5400
- B5500
- B5602
- B5700
- B5800

For more choice, please contact us.



FLUSH MOUNT



HOUSING ORDERING GUIDE / YOUR PRODUCT CODE

SERIES	CONSTRUCTION	FIRE RATING	WIRING TYPE
<input type="radio"/> A5-IA-F Fire rated Downlight Housing	<input type="radio"/> New Construction	<input type="radio"/> 2 Hours	<input type="radio"/> Fast connection terminal <input type="radio"/> E26 Socket

LIGHT SOURCE ORDERING GUIDE / YOUR PRODUCT CODE

RETROFIT	LUMEN	CRI	FINISH	DIMMING
<input type="radio"/> 5" Retrofit	<input type="radio"/> 1100lm	<input type="radio"/> 80+	<input type="radio"/> White	<input type="radio"/> Non-Dimming
<input type="radio"/> PAR30	<input type="radio"/> 1250lm	<input type="radio"/> 90+	<input type="radio"/> Black	<input type="radio"/> TRIAC
			<input type="radio"/> Satin Nickel	<input type="radio"/> ELV

* Customized Also Available

6" NEW CONSTRUCTION FIRE RATED IC AIRTIGHT DOWNLIGHT HOUSING

A6-IA-F



Retrofit Type	Voltage	Frequency	Dimming
6" Retrofit	120V AC/ 277V AC	50/60 Hz	TRIAC/ ELV/ NONE
PAR30 Bulb			

*Please contact Liteharbor for details.

DIMENSIONS

- L: 12 5/8"
- W: 9 1/16"
- H: 7 3/4"
- a: 6"

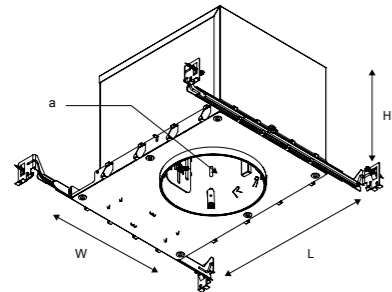

DESIGNED FOR 2" X 8" JOIST CONSTRUCTION

DESCRIPTION

This is a 6" fire and sound rated downlight housing, suitable for a variety of light sources such as LEDs and incandescent, it can be fitted to a wide range of 6 inch retrofit stands. Specification grade fire-rated new construction housing. The double wall fixture incorporates a non-combustible fiber insulation to prevent passage of flames, toxic gases, ignitable gasses into ceiling plenums. The cULus listed housing is rated for a minimum of 2 hours protection. The noncombustible fiber fill also acts as sound deadening material eliminating the transfer of sound between floors. Suitable for commercial, multi-family and residential applications. Ceiling thickness: 1/2" up to 1 1/4". Suitable for wet locations.

HOUSING

Fire and sound rated housing, Up to 120 minute fire rated L500 (floor-ceiling) & P500 (roof-ceiling) design. Die formed cool steel construction. Snap on cool steel cover. Non-combustible matt insulation.

JUNCTION BOX

4 in 4 out galvanized steel junction box.

BAR HANGER

Pre-installed adjustable bar hangers engineered to accommodate lumber, laminated beams and T-bar.

APPLICATIONS

Apply to automotive and parking, education, government, healthcare, hospitality, offices and banks, religious, retail. Especially in areas with limited ventilation, such as closets and utility rooms.

LISTING/ WARRANTY

UL listed to US and Canadian standards for damp location W/Feed through. IC rated, Title 24 compliant, UL 263 certificated up to 2 hour fire rated. 3 Year LED Limited Warranty



HOUSING ORDERING GUIDE / YOUR PRODUCT CODE

SERIES	CONSTRUCTION	FIRE RATING	WIRING TYPE
<input type="radio"/> A6-IA-F Fire rated Downlight Housing	<input type="radio"/> New Construction	<input type="radio"/> 2 Hours	<input type="radio"/> Fast connection terminal <input type="radio"/> E26 Socket

LIGHT SOURCE ORDERING GUIDE / YOUR PRODUCT CODE

RETROFIT	LUMEN	CRI	FINISH	DIMMING
<input type="radio"/> 6" Retrofit	<input type="radio"/> 750lm	<input type="radio"/> 80+	<input type="radio"/> White	<input type="radio"/> Non-Dimming
<input type="radio"/> PAR30 Bulb	<input type="radio"/> 650lm	<input type="radio"/> 90+	<input type="radio"/> Black <input type="radio"/> Satin Nickel	<input type="radio"/> TRIAC <input type="radio"/> ELV

* Customized Also Available

6" NEW CONSTRUCTION FIRE RATED IC AIRTIGHT DOWNLIGHT HOUSING



6" Retrofit

Fire and sound rated housing, Up to 120 minute fire rated L500 (floor-ceiling) & P500 (roof-ceiling) design. Die formed cool steel construction. Snap on cool steel cover.

- BL6-001
- BL6-001-1
- BL6-001-E
- BL6-001-COB
- BL6-003
- BL6-004
- BEL6-001
- BWL6-001
- BRL6-001-SF
- BRL6-002-SF



6" Trim (PAR30 Bulb)

Fire and sound rated housing, Up to 120 minute fire rated L500 (floor-ceiling) & P500 (roof-ceiling) design. Die formed cool steel construction. Snap on cool steel cover.

- B6001
- B6001L
- B6002
- B6002L
- B6003
- B6003B
- B6007
- B6007L
- B6011
- B6012
- B6012W
- B6013
- B6016
- B6017
- B6017L
- B6021
- B6021L
- B6022
- B6026
- B6300
- B6400
- B6500
- B6700
- B6800

For more choice, please contact us.



FLUSH MOUNT





HIGH-END DIE-CASTING ALUMINUM NEW CONSTRUCTION FIRE RATED LED DOWNLIGHT HOUSING

Die-casting Aluminum 4 in 4 out ultra-thin fire rated junction box for new construction applications, it's designed for surface mount ceiling fixtures. Adapt to a variety of surface mounted lamp, such as Liteharbor's LED disk light, ceiling light, etc.

4" NEW CONSTRUCTION FIRE RATED LED DOWNLIGHT HOUSING

A4-F-0



DESCRIPTION

This is a 4 in 4 out ultra-thin new construction fire rated junction box, designed for surface mount ceiling fixtures. Cold plate housing sprayed with red powder for 2 hours fire rated. Guided-slots on each side allow the box to be easily adjusted and secured by simply loosening the screws, built-in adapter allows it to be adjusted from 1/2" up to 1 1/4". Adapt to a variety of surface mounted lamp, such as Liteharbor's LED disk light, ceiling light, etc. Suitable for wet locations.

APPLICATIONS

Apply to automotive and parking, education, government, healthcare, hospitality, offices and banks, religious, retail. Especially in areas with limited ventilation, such as closets and utility rooms.

DIMENSIONS

L: 12 1/16"
W: 7 1/2"
H: 7 3/4"
a: 4 1/16"

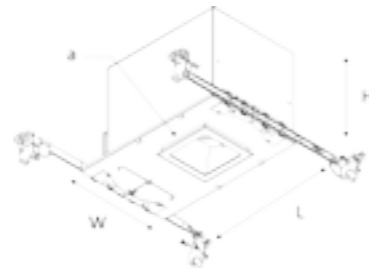

DESIGNED FOR 2" X 8" JOIST CONSTRUCTION
PACKAGING: Outer Box: 76.5*68*14.5 CM 6 PCS/CTN



Retrofit Type	Voltage	Frequency	Dimming
BL4-001 Round shape retrofit	120V AC	50/60 Hz	TRIAC/ NONE
BSL4-001 Square shape retrofit			

*Please contact Liteharbor for details.

LISTING/ WARRANTY

ETL listed to US and Canadian standards for damp location W/Feed through. IC rated, Title 24 compliant, up to 2hour fire rated. 3 Year Limited Warranty.



BL4-003 BL6-003 BL4-003-2 BL6-003-2 FLUSH MOUNT FLUSH MOUNT

For more choice, please contact us.

HOUSING ORDERING GUIDE / YOUR PRODUCT CODE

SERIES	CONSTRUCTION	FIRE RATING
<input type="radio"/> A4-F-S Fire rated Junction Box	<input type="radio"/> New Construction	<input type="radio"/> 2 Hours

LIGHT SOURCE ORDERING GUIDE / YOUR PRODUCT CODE

RETROFIT	LUMEN	CRI	FINISH	DIMMING
<input type="radio"/> BL4-003	<input type="radio"/> 750lm	<input type="radio"/> 80+	<input type="radio"/> White	<input type="radio"/> TRIAC
<input type="radio"/> BL6-003		<input type="radio"/> 90+	<input type="radio"/> Black	<input type="radio"/> ELV
<input type="radio"/> BL4-003-2			<input type="radio"/> Satin Nickel	
<input type="radio"/> BL6-003-2				

* Customized Also Available

4" NEW CONSTRUCTION FIRE RATED LED DOWNLIGHT HOUSING

A4-F-S

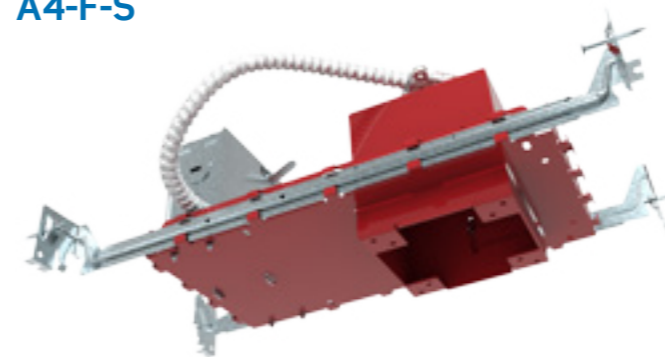

DESCRIPTION

This is a 4 in 4 out ultra-thin new construction fire rated junction box, designed for surface mount ceiling fixtures. Cold plate housing sprayed with red powder for 2 hours fire rated. Guided-slots on each side allow the box to be easily adjusted and secured by simply loosening the screws, built-in adapter allows it to be adjusted from 1/2" up to 1 1/4". Adapt to a variety of surface mounted lamp, such as Liteharbor's LED disk light, ceiling light, etc. Suitable for wet locations.

APPLICATIONS

Apply to automotive and parking, education, government, healthcare, hospitality, offices and banks, religious, retail. Especially in areas with limited ventilation, such as closets and utility rooms.



Retrofit Type	Voltage	Frequency	Dimming
BL4-003	120V AC/ 277V AC	50/60 Hz	TRIAC/ NONE
BL6-003			
BL4-003-2			
BL6-003-2			

*Please contact Liteharbor for details.

LISTING/ WARRANTY

ETL listed to US and Canadian standards for damp location W/Feed through. IC rated, Title 24 compliant, up to 2hour fire rated. 3 Year Limited Warranty.



DIMENSIONS

L: 10 1/2"
W: 5 3/16"
H: 3 13/16"
a: 3 3/4"x3 3/4"

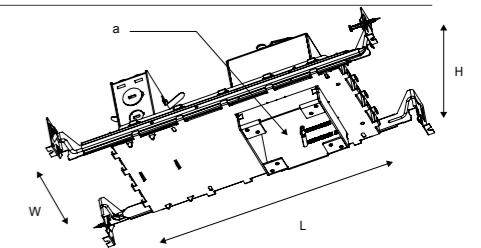

DESIGNED FOR 2" X 8" JOIST CONSTRUCTION
PACKAGING: Outer Box: 76.5*68*14.5 CM 6 PCS/CTN



BL4-003 BL6-003 BL4-003-2 BL6-003-2 FLUSH MOUNT FLUSH MOUNT

For more choice, please contact us.

HOUSING ORDERING GUIDE / YOUR PRODUCT CODE

SERIES	CONSTRUCTION	FIRE RATING
<input type="radio"/> A4-F-S Fire rated Junction Box	<input type="radio"/> New Construction	<input type="radio"/> 2 Hours

LIGHT SOURCE ORDERING GUIDE / YOUR PRODUCT CODE

RETROFIT	LUMEN	CRI	FINISH	DIMMING
<input type="radio"/> BL4-003	<input type="radio"/> 750lm	<input type="radio"/> 80+	<input type="radio"/> White	<input type="radio"/> TRIAC
<input type="radio"/> BL6-003		<input type="radio"/> 90+	<input type="radio"/> Black	<input type="radio"/> ELV
<input type="radio"/> BL4-003-2			<input type="radio"/> Satin Nickel	
<input type="radio"/> BL6-003-2				

* Customized Also Available

4" CONSTRUCTION OCTAGON FIRE RATED LED DOWNLIGHT HOUSING

A4-F-OL



DESCRIPTION

This is a 4-inch octagonal lamp with fire protection for a variety of light sources such as 4-inch retrofit stands. Specification grade fire-rated new construction housing. The double wall fixture incorporates a non-combustible fiber insulation to prevent passage of flames, toxic gases, ignitable gasses into ceiling plenums. The ETL listed housing is rated for a minimum of 2 hours protection. The noncombustible fiber fill also acts as sound deadening material eliminating the transfer of sound between floors. Suitable for commercial, multi-family and residential applications. Mountable ceiling thickness: 1/2" up to 1 1/4". Suitable for wet locations.

HOUSING

Using galvanized sheet, designed for high strength.

JUNCTION BOX

4 in 4 out galvanized steel junction box.

HANGER BAR

Pre-installed adjustable bar hangers engineered to accommodate lumber, laminated beams and T-bar.

RETROFIT

Can install the 4" retrofit and ceiling light.

APPLICATIONS

Apply to automotive and parking, education, government, healthcare, hospitality, offices and banks, religious, retail.

LISTING/ WARRANTY

UL listed to US and Canadian standards for damp location W/Feed through. IC rated, Title 24 compliant, UL 263 certificated up to 2 hour fire rated. 3 Year LED Limited Warranty



Retrofit Type	Voltage	Frequency	Dimming
4" Retrofit	120V AC/ 277V AC	50/60 Hz	TRIAC/ ELV/ NONE

*Please contact Liteharbor for details.

DIMENSIONS

L: 4 7/32"

W: 4 7/32"

H: 3 13/16"

a: 4 17/32"

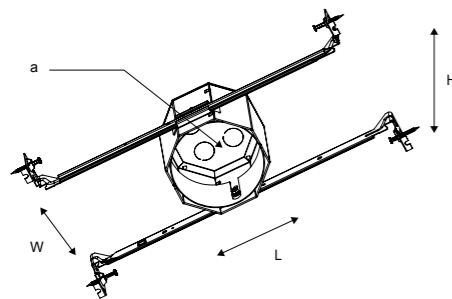

DESIGNED FOR 2" X 8" JOIST CONSTRUCTION

PACKAGING: Outer Box: 76.5*68*14.5 CM 6 PCS/CTN

HOUSING ORDERING GUIDE / YOUR PRODUCT CODE

SERIES	CONSTRUCTION	FIRE RATING
<input type="radio"/> A4-F-OL Fire rated Downlight Housing	<input type="radio"/> New Construction	<input type="radio"/> 2 Hours

LIGHT SOURCE ORDERING GUIDE / YOUR PRODUCT CODE

RETROFIT	LUMEN	CRI	FINISH	DIMMING
<input type="radio"/> 4" Retrofit	<input type="radio"/> 750lm <input type="radio"/> 650lm	<input type="radio"/> 80+ <input type="radio"/> 90+	<input type="radio"/> White <input type="radio"/> Black <input type="radio"/> Satin Nickel	<input type="radio"/> Non-Dimming <input type="radio"/> TRIAC <input type="radio"/> ELV

* Customized Also Available

4" CONSTRUCTION OCTAGON FIRE RATED LED DOWNLIGHT HOUSING

4" Retrofit

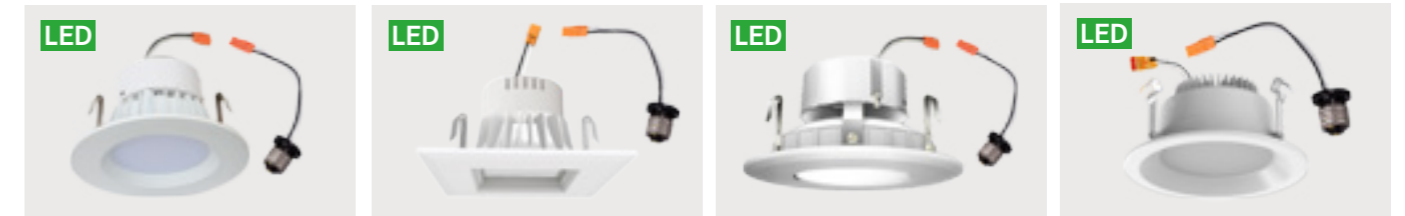

BL4-001

BSL4-001

BL4-001-E

BL4-002

Fire and sound rated housing, Up to 120 minute fire rated L500 (floor-ceiling) & P500 (roof-ceiling) design. Die formed cool steel construction. Snap on cool steel cover.

· BL4-001 · BSL4-001 · BL4-001-1 · BL4-001-E · BL4-001-E · BL4-002 · BAL4-001 · BEL4-001

For more choices, please contact us



FLUSH MOUNT





HIGH QUALITY ALUMINUM FIRE REATED JUNCTION BOX

New Construction 4 inch Octagon/Square shape lamp with fire protection for a variety of light sources such as 4-inch retrofit stands. The incombustible fiber fill also acts as sound dealing material eliminating the transfer of sound between floors. Suitable for commercial and residential applications.

NEW CONSTRUCTION OCTAGON FIRE RATED JUNCTION BOX

FJ-BOX-0

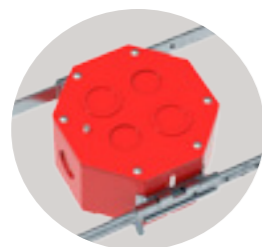
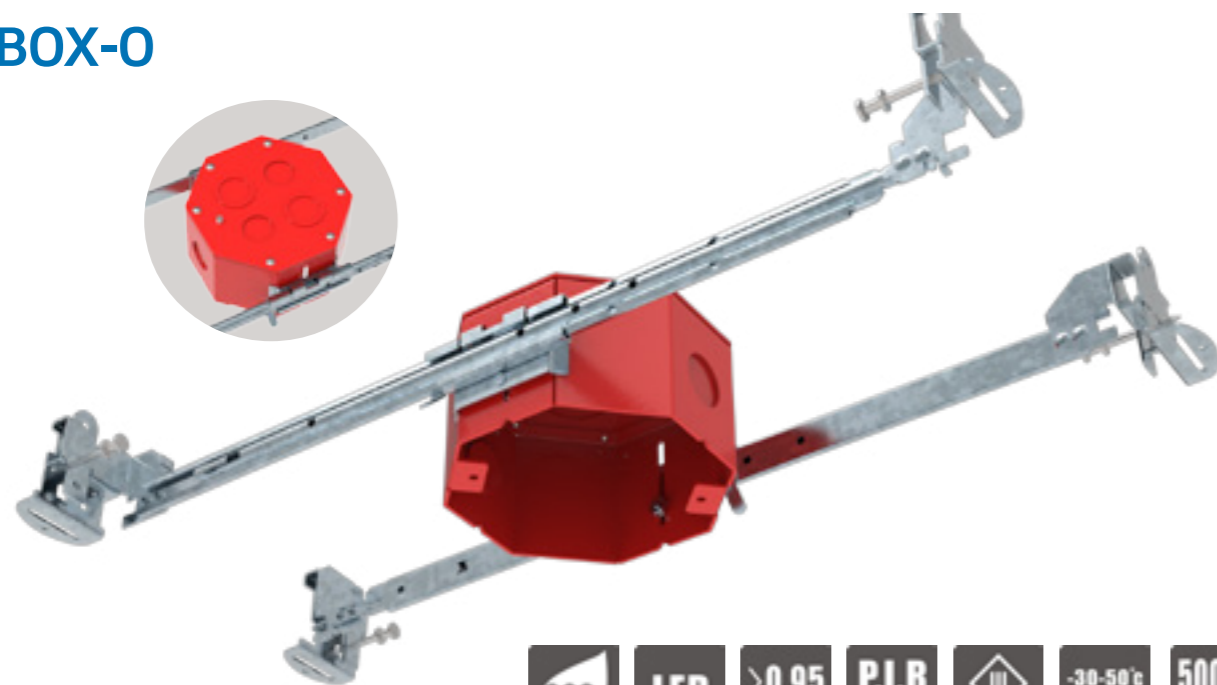

Retrofit Type	Voltage	Frequency	Dimming
BL4-003	120V AC/ 277V AC	50/60 Hz	TRIAC/ NONE
BL6-003			
BL4-003-2			
BL6-003-2			

*Please contact Liteharbor for details.

LISTING/ WARRANTY

ETL listed to US and Canadian standards for damp location W/Feed through. IC rated, Title 24 compliant, up to 2hour fire rated.
3 Year Limited Warranty.



DESCRIPTION

This is a 4-inch octagonal lamp with fire protection for a variety of light sources such as 4-inch retrofit stands. Specification grade fire-rated new construction housing. The double wall fixture incorporates a non-combustible fiber insulation to prevent passage of flames, toxic gases, ignitable gasses into ceiling plenums. The ETL listed housing is rated for a minimum of 2 hours protection. The noncombustible fiber fill also acts as sound deadening material eliminating the transfer of sound between floors. Suitable for commercial, multi-family and residential applications.
Mountable ceiling thickness: 1/2" up to 1 1/4".
Suitable for wet locations.

APPLICATIONS

Apply to automotive and parking, education, government, healthcare, hospitality, offices and banks, religious, retail. Especially in areas with limited ventilation, such as closets and utility rooms.



NEW CONSTRUCTION OCTAGON FIRE RATED JUNCTION BOX

DIMENSIONS

- L: 4 7/32"
- W: 4 7/32"
- H: 2 1/2"
- a: 4 17/32"

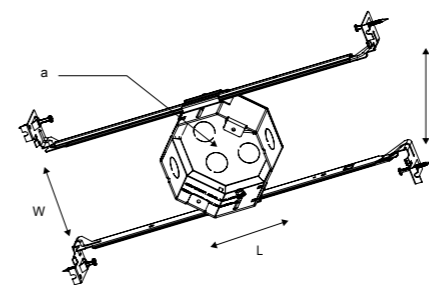

DESIGNED FOR 2" X 8" JOIST CONSTRUCTION

PACKAGING

Outer Box: 76.5*68*14.5 CM 6 PCS/CTN

HOUSING ORDERING GUIDE / YOUR PRODUCT CODE

SERIES	CONSTRUCTION	FIRE RATING
<input type="radio"/> FJ-BOX-0 Fire rated Junction Box	<input type="radio"/> New Construction	<input type="radio"/> 2 Hours

LIGHT SOURCE ORDERING GUIDE / YOUR PRODUCT CODE

RETROFIT	LUMEN	CRI	FINISH	DIMMING
<input type="radio"/> BL4-003	<input type="radio"/> 750lm	<input type="radio"/> 80+	<input type="radio"/> White	<input type="radio"/> TRIAC
<input type="radio"/> BL6-003		<input type="radio"/> 90+	<input type="radio"/> Black	<input type="radio"/> ELV
<input type="radio"/> BL4-003-2			<input type="radio"/> Satin Nickel	
<input type="radio"/> BL6-003-2				

* Customized Also Available



For more choice, please contact us.



NEW CONSTRUCTION SQUARE FIRE RATED JUNCTION BOX

FJ-BOX-S

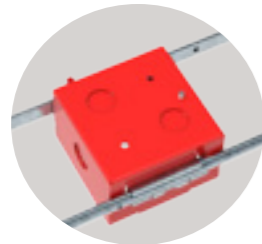
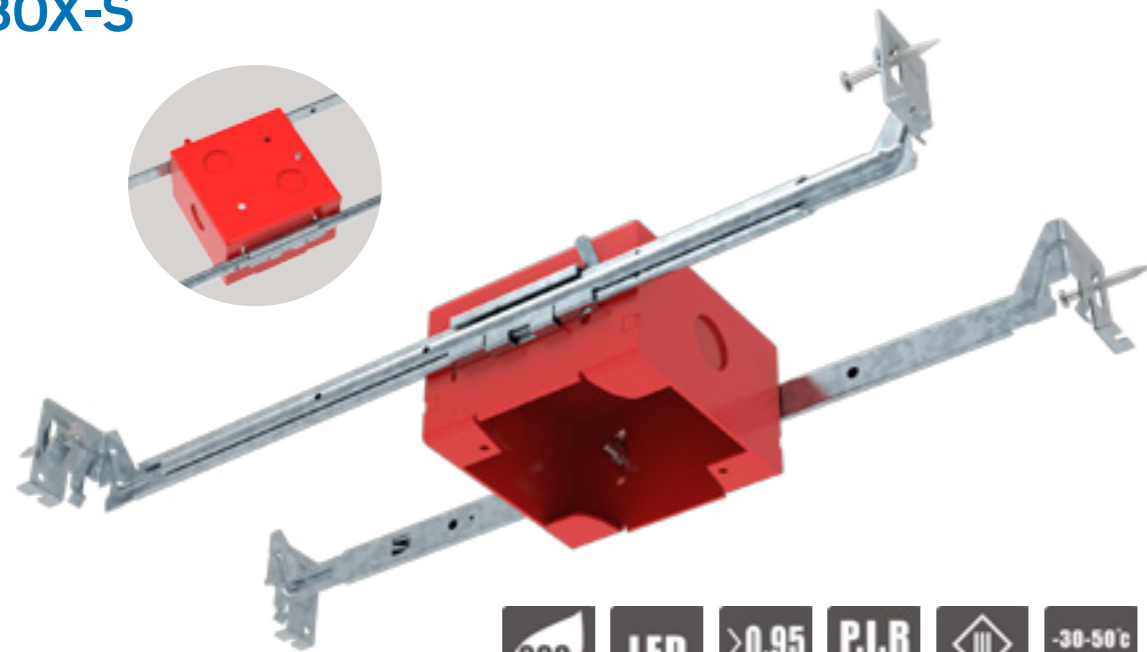

Retrofit Type	Voltage	Frequency	Dimming
BL4-003	120V AC/ 277V AC	50/60 Hz	TRIAC/ NONE
BL6-003			
BL4-003-2			
BL6-003-2			

*Please contact Liteharbor for details.

LISTING/ WARRANTY

ETL listed to US and Canadian standards for damp location W/Feed through. IC rated, Title 24 compliant, up to 2hour fire rated.
3 Year Limited Warranty.



DESCRIPTION

This is a 4 in 4 out ultra-thin new construction fire rated junction box, designed for surface mount ceiling fixtures.
Cold plate housing sprayed with red powder for 2 hours fire rated.
Guided-slots on each side allow the box to be easily adjusted and secured by simply loosening the screws, built-in adapter allows it to be adjusted from 1/2" up to 1 1/4".
Adapt to a variety of surface mounted lamp, such as Liteharbor's LED disk light, etc.
Suitable for wet locations.

APPLICATIONS

Apply to automotive and parking, education, government, healthcare, hospitality, offices and banks, religious, retail.
Especially in areas with limited ventilation, such as closets and utility rooms.

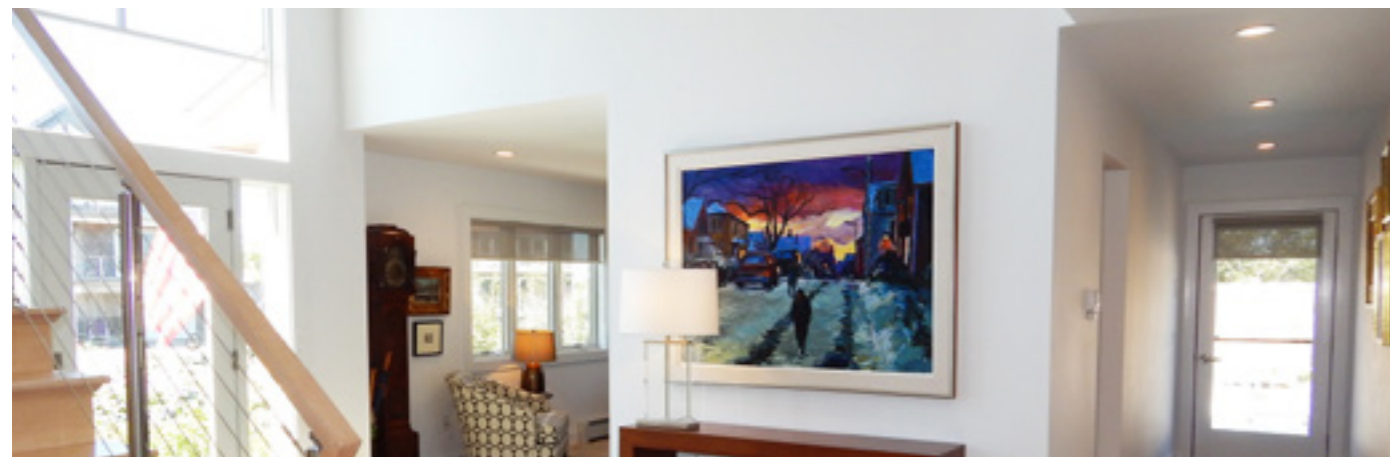

NEW CONSTRUCTION SQUARE FIRE RATED JUNCTION BOX

DIMENSIONS

- L: 4 3/4"
- W: 3 3/4"
- H: 2 1/2"
- a: 4 3/4"x4 3/4"

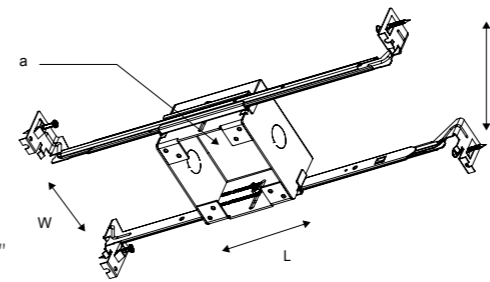

DESIGNED FOR 2" X 8" JOIST CONSTRUCTION

PACKAGING
Outer Box: 76.5*68*14.5 CM 6 PCS/CTN

HOUSING ORDERING GUIDE / YOUR PRODUCT CODE

SERIES	CONSTRUCTION	FIRE RATING
<input type="radio"/> FJ-BOX-S Fire rated Junction Box	<input type="radio"/> New Construction	<input type="radio"/> 2 Hours

LIGHT SOURCE ORDERING GUIDE / YOUR PRODUCT CODE

RETROFIT	LUMEN	CRI	FINISH	DIMMING
<input type="radio"/> BL4-003	<input type="radio"/> 750lm	<input type="radio"/> 80+	<input type="radio"/> White	<input type="radio"/> TRIAC
<input type="radio"/> BL6-003		<input type="radio"/> 90+	<input type="radio"/> Black	<input type="radio"/> ELV
<input type="radio"/> BL4-003-2			<input type="radio"/> Satin Nickel	
<input type="radio"/> BL6-003-2				

* Customized Also Available



For more choice, please contact us.





StarSky™
Cross Tee Linear Light

DESIGN YOUR CEILING TEE LINEAR LIGHT

LED Cross Tee Linear Lights, mounted in the ceiling Cross Tee, can design various lighting shapes according to the size of the standard Cross Tee. Just like a group of stars grouped into various constellations. Hence Liteharbor LED Cross Tee Linear Lights Series are named as Star-sky.



Basic frame: Main tee, deputy tee, side tee

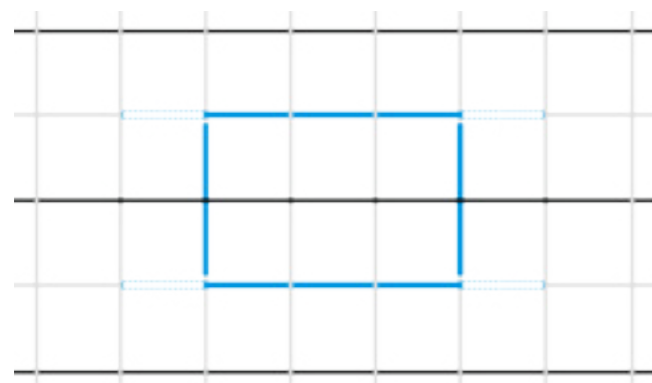
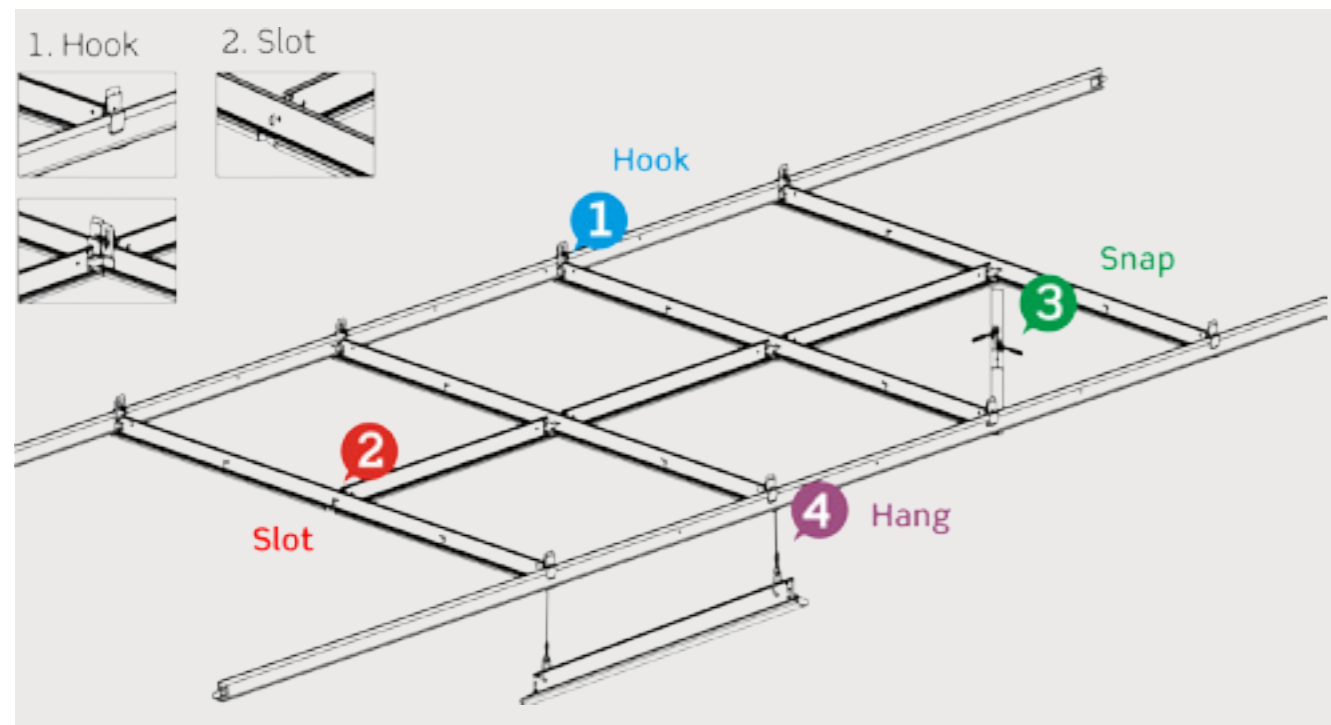

Mounting Layout
Configuration as shown in photo

- 4L Model
- 2 Foot Light
- One-piece Main Runner

The Star-Sky Series has four different mounting ways, slot, hook, hang & snap. The slot mounting allows the line fitting to directly replace existing ceiling Tee. It is simple as removing the tee and fitting in with line. For hook mounting, it mounts the linear light directly onto the tee without the need to removing the existing Tee. This is most suitable for the main Tee. The wire hanger allows the light to directly hang off the ceiling. Snap mounting allows the lamp to recess into the ceiling.

INSTALLATION INSTRUCTIONS



1. Hook
Line directly into main Tee. Adjustable width and height, enable Line slot mounting fit into all existing tee holes.



2. Slot
Line hook itself onto any existing tee. Both main tee and side Tee. Has adjustable width and height.



3. Snap
Line can recess into thin cut holes. Allow line to be place on any ceiling board in more position and situation.



4. Hang
Line has attached itself onto any ceiling and drop down. Provide existing task lighting or personal lighting.

STAR-SKY SERIES CROSS TEE LINEAR LIGHT

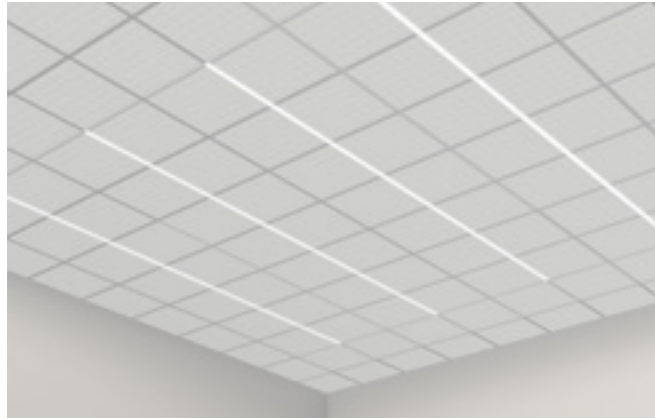

Line Type

Line type, give you a simple and comfortable irradiation effect.

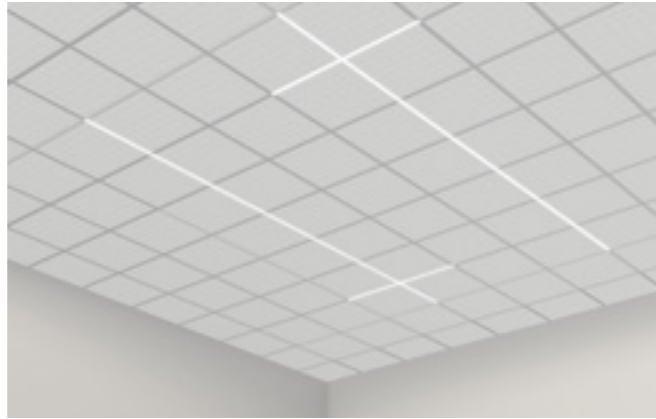

Parallel Intersection Type

Parallel Intersection Type, the shape is creative.



Square Type

Two squares of different sizes, the effect is more regular.



Arcuate Type

Two symmetrical arches formed make them more eye-catching.



Overlapping Rectangle Type

The overlapping rectangle brings different visual effects.



Special Design

DIY your Ceiling Lighting with your company Logo or other specific design.

STAR-SKY SERIES CROSS TEE LINEAR LIGHT



CONNECTION TYPE
- LED Quick Connector
- CAT5 Connector



StarSky™
Cross Tee Linear Light

Power: 10W/15W
Voltage: AC 120V~277V
Frequency: 50/60Hz
Power factor: >0.98
CRI: 80+/90+
Dimmable: NONE/0-10V/TRIAC
CCT: 3000K/CCT Tunable
Emergency Backup: Yes/No

FEATURES

This product is a long linear light fixture for keel suspended ceiling, a new way to seamlessly integrate recessed downlights with architectural suspension systems. For the first time, LED downlights can be placed at the intersection of the ceiling - allowing for perfect alignment of lighting and architecture.

This series has four different mounting, slot, hook, hang & snap. The slot mounting allow the line fitting to directly replace existing ceiling grid. It is as simple as removing the grid and fitting in with line. For hook mounting, it mounts the linear light directly onto the grid without the need to removing the existing grid. This is most suitable for the main grid. The wire hanger allows the light to directly hang off the ceiling. Snaps mounting allow the lamp to recess into the ceiling.

LED line unique mounting system allows the lamp to be place directly into the ceiling grid. we also offer mounting pieces that can form different shapes. You can create your own shape on the ceiling. With this linear fixture on the ceiling, there is no requirement for additional holes to made, just build your own shape and create a unique ceiling.

Aluminum housing and high heat conductive alloy with built in protection for short circuit/overload/over voltage/over temperature. Smart voltage remains constant to ensure flexible connection with the line.

CONSTRUCTION

Using energy saving LED light source, a variety of CCT is optional, and other CCT can be provided according to the requirements.

Applications

Apply to offices, shopping malls.

LISTING / WARRANTY

ETL listed to US and Canadian standards for damp location W/Feed through.
5 Year Limited Warranty.



DIMENSIONS

W: 15/16"
H: 3 1/8"



L: 2FT/4FT

INSTALLATION INSTRUCTIONS

1. Hook



2. Slot



3. Snap



4. Hang



ORDERING GUIDE / YOUR PRODUCT CODE

SERIES	DIMENSIONS	LUMEN	MOUNTING	FINISH	CONNECTION TYPE	CUSTOMIZED FUNCTIONS
○ MB-60	○ 2 ft. light	○ 1200lm	○ 3000K/80+ CRI	○ Non-Dimming	○ LED Quick Connector	○ Emergency Backup
○ Ceiling Keel Linear Light	○ 4 ft. length	○ 1800lm	○ 3000K/90+ CRI	○ 0-10V Dimming	○ CAT5 Connector	
			○ CCT tunable	○ TRIAC		

* Customized Also Available

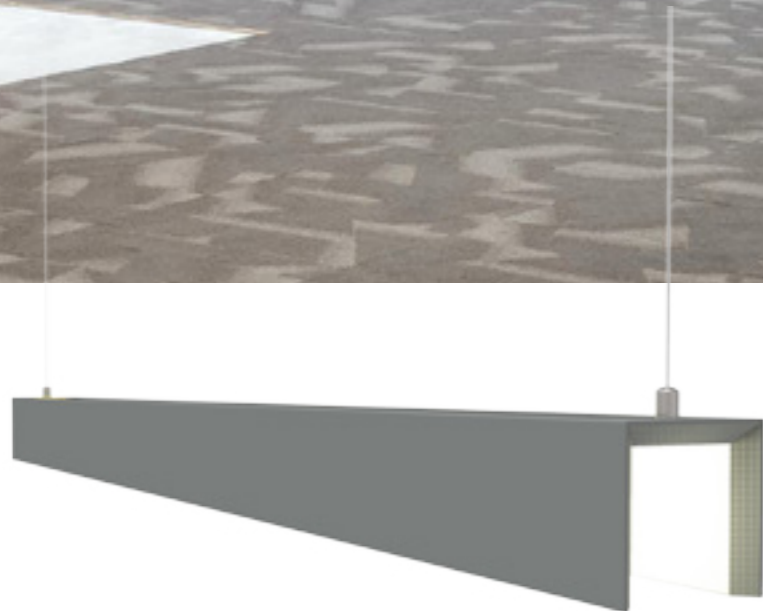

LED LINEAR WRAP LIGHT

SURFACE AND SUSPENDED MOUNTED LED LINEAR WRAP LIGHT

Liteharbor LED Linear Wrap Light is a high lumen, thin, beautiful appearance, safe and reliable, convenient installation and easy maintenance linear light. It uses high transmittance pc cover and 2835 SMD LED light source. Can suitable for the commercial and industrial applications.

ELEGANT DESIGN COMMERCIAL LED SMD LINEAR LIGHT



FEATURES

Simple elegant linear fixture suitable for high end offices, lounges, retail space and showrooms.
Invisible LED source, produces high quality illumination with CRI 80/90+.
Integrated 0-10V or SCR dim driver for even greater energy saving.
Simple pendant installation with aircraft cable.
Adaptable hardware convert individual fixtures to linkable light for continuous run.
High-quality optical design, lights upward for unique ambient lighting, and efficient down light for task lighting.

Description

This next generation LED linear light is made of extruded aluminum for excellent heat dissipation ensure long product life.
High performance LED source is hidden, produces soft and even illumination.
The simple yet elegant construction allows for individual pendant installation or continuous run providing up and down light to small individual offices or large open plan.

APPLICATION

Apply to offices, shopping malls.

LISTING / WARRANTY

ETL listed to US and Canadian standards for damp location W/Feed through.
5-year limited warranty on LED and Driver.



DIMENSIONS

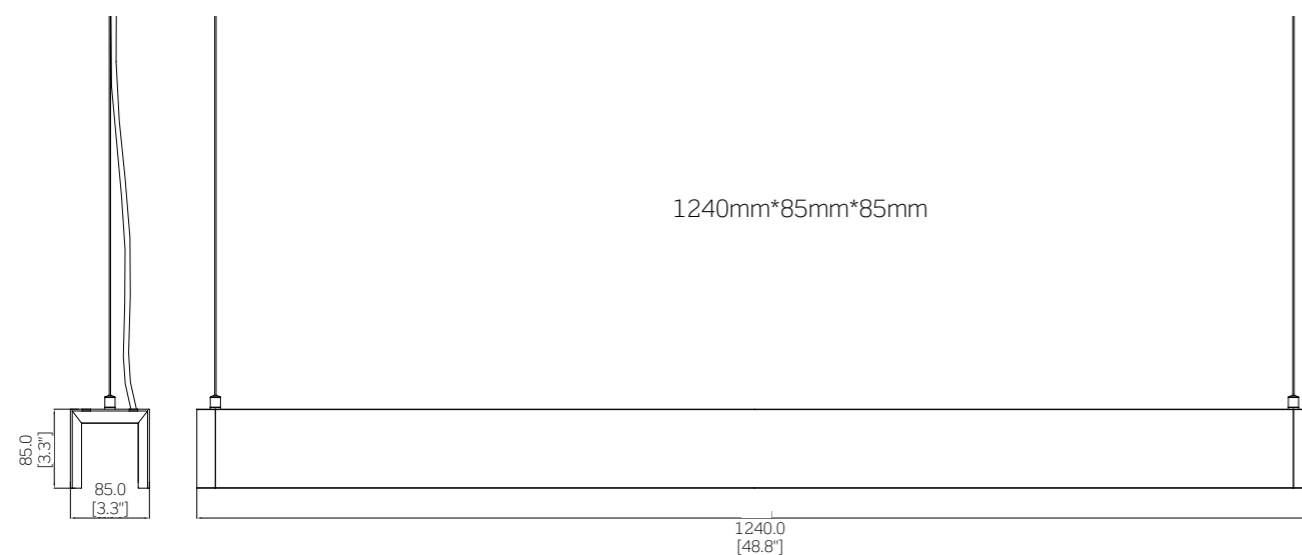

ELEGANT DESIGN COMMERCIAL LED SMD LINEAR LIGHT

STRUCTURE ELUCIDATION

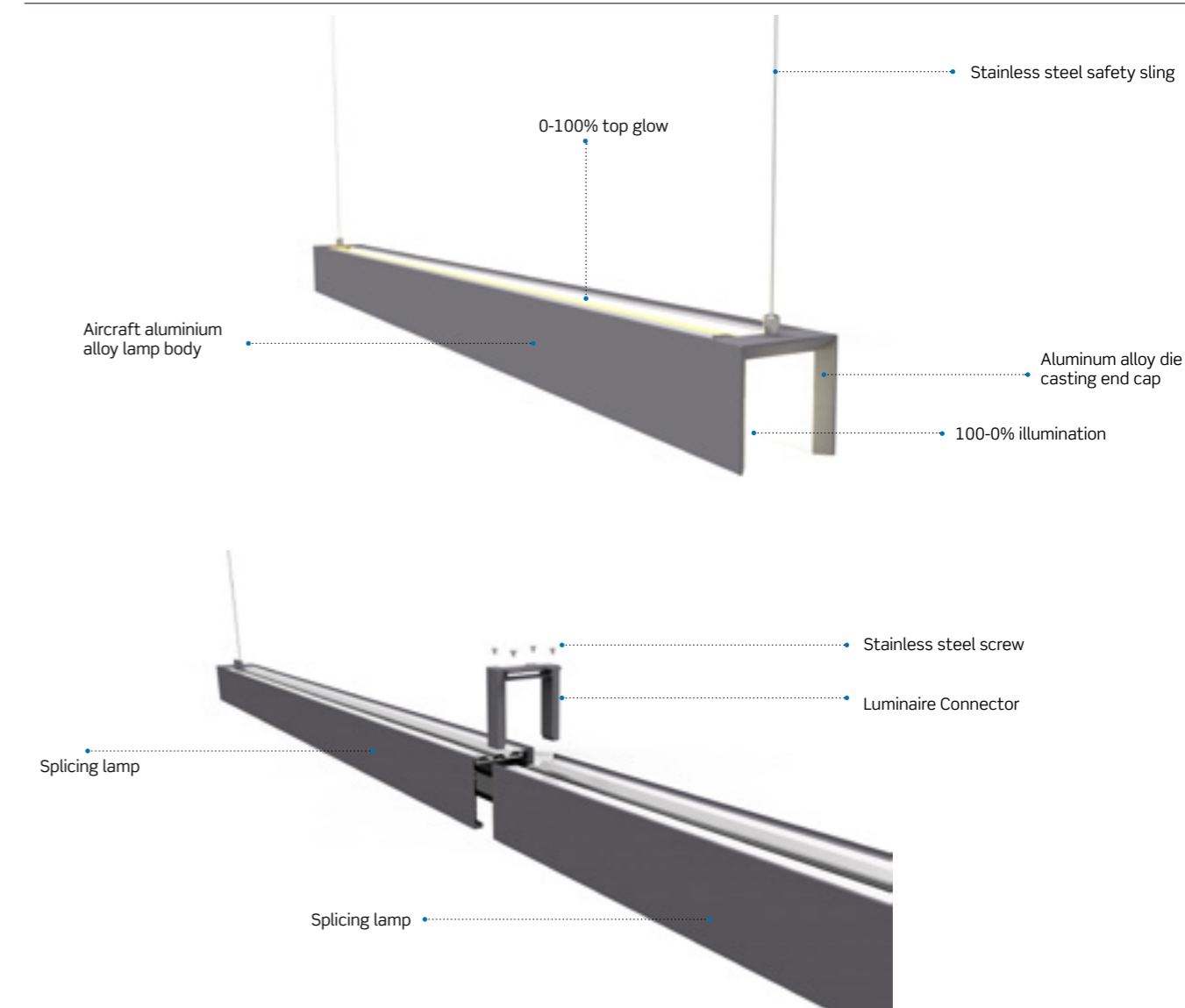

STITCHING DISPLAY

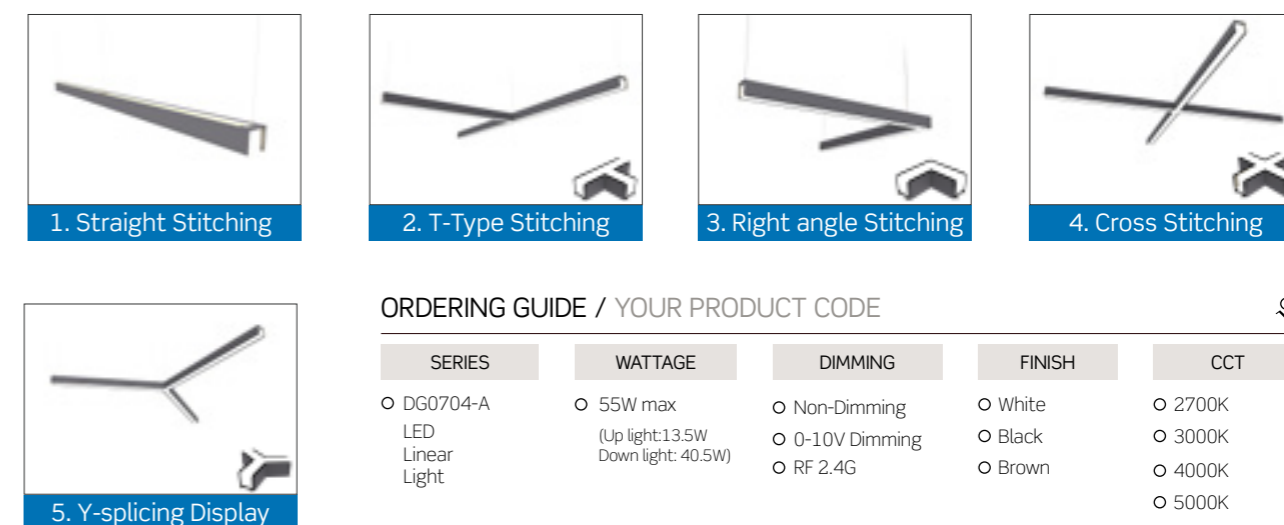

ORDERING GUIDE / YOUR PRODUCT CODE

SERIES	WATTAGE	DIMMING	FINISH	CCT
○ DG0704-A LED Linear Light	○ 55W max (Up light: 13.5W Down light: 40.5W)	○ Non-Dimming ○ 0-10V Dimming ○ RF 2.4G	○ White ○ Black ○ Brown	○ 2700K ○ 3000K ○ 4000K ○ 5000K ○ CCT Tunable

* Other special requirements please confirm with factory.

HIGH QUALITY SUSPENDED MOUNTED LED LINEAR LIGHT



DG0704-B

Power: 55W max
(Up light: 13.5W, Down light: 40.5W)

Voltage: 120-277V

PF: >0.9

CRI: 80+/90+

CCT: 2700-5000K

Frequency: 50/60Hz

Dimming: TRIAC, 0-10V, RF 2.4G

Total Lumen: 5000-6500lm

Material: Aluminium

Color: White/Black/Brown

Dimensions: 1240mm*85mm*85mm



Beam Angle: Up: 115° / Down: 105°

FEATURES

- Simple elegant linear fixture suitable for high end offices, lounges, retail space and showrooms.
- Invisible LED source, produces high quality illumination with CRI 80/90+.
- Integrated 0-10V or SCR dim driver for even greater energy saving.
- Simple pendant installation with aircraft cable.
- Adaptable hardware convert individual fixtures to linkable light for continuous run.
- High-quality optical design, lights upward for unique ambient lighting, and efficient down light for task lighting.

Description

This next generation LED linear light is made of extruded aluminum for excellent heat dissipation ensure long product life. High performance LED source is hidden, produces soft and even illumination. The simple yet elegant construction allows for individual pendant installation or continuous run providing up and down light to small individual offices or large open plan.

APPLICATION

Apply to offices, shopping malls.

LISTING / WARRANTY

ETL listed to US and Canadian standards for damp location W/Feed through.
5-year limited warranty on LED and Driver.



DIMENSIONS

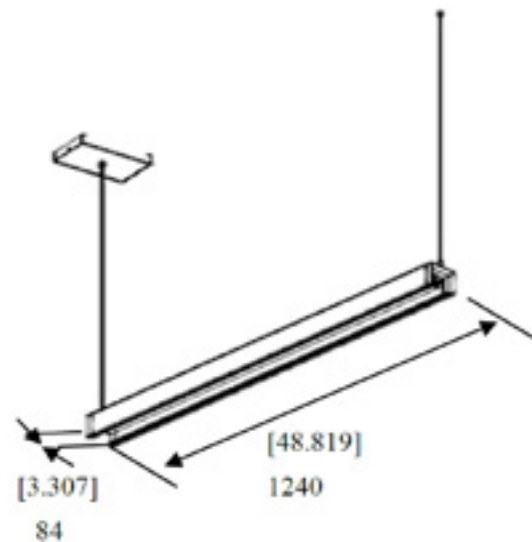

HIGH QUALITY SUSPENDED MOUNTED LED LINEAR LIGHT

STRUCTURE ELUCIDATION

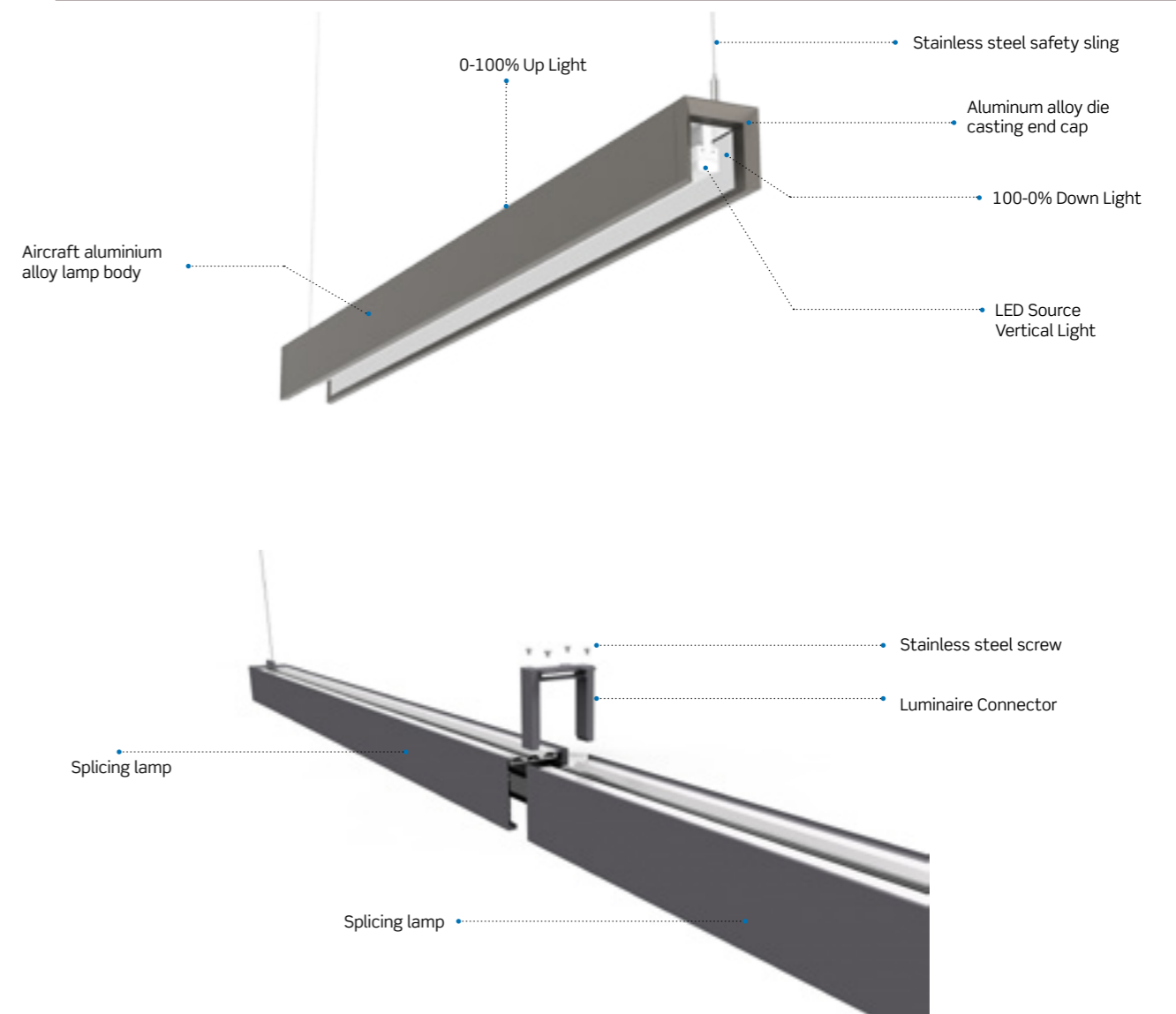

STITCHING DISPLAY

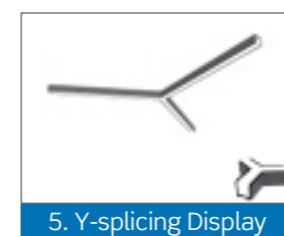
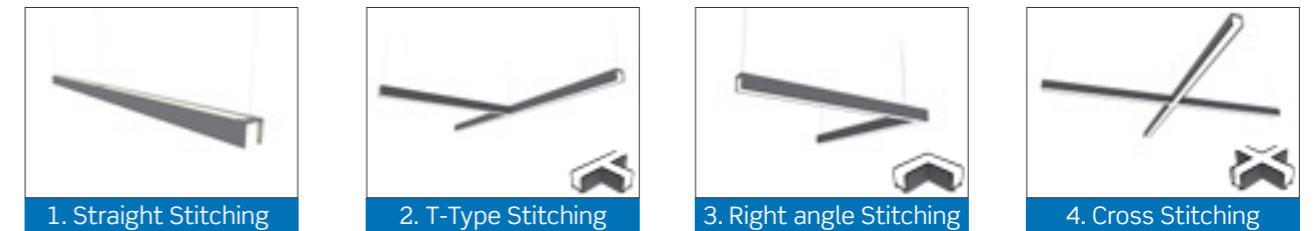

ORDERING GUIDE / YOUR PRODUCT CODE

SERIES	WATTAGE	DIMMING	FINISH	CCT/CRI
○ DG0704-B LED Linear Light	○ 55W max (Up light: 13.5W Down light: 40.5W)	○ Non-Dimming ○ 0-10V Dimming ○ TRIAC ○ RF 2.4G	○ White ○ Black ○ Grey	○ 3000K/80+ CRI ○ 3000K/90+ CRI ○ CCT Tunable

* Other special requirements please confirm with factory.

HIGH-PERFORMANCE 2X2 RECESSED LED TROFFER

SINGLE SUSPENDED INSTALLATION

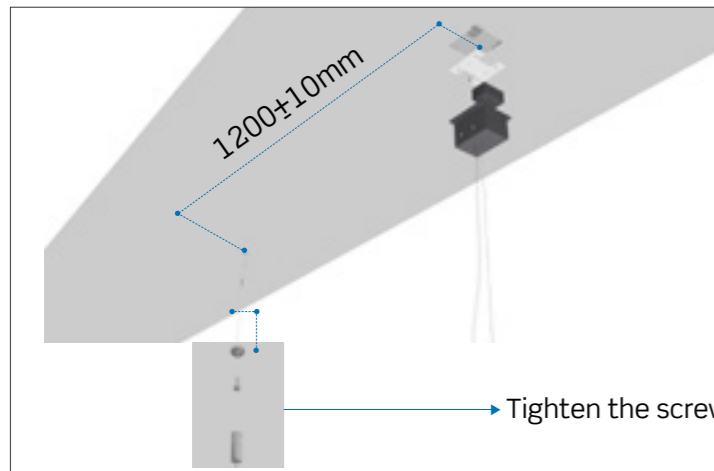

Step 1

Make the wires through the holes of the surface mounted kit, fix the kit on the J-box, attach the fit on the J-box by screws, fix the holders of suspending rope and surface mounted frame on the ceiling (make sure the distance between the 2 ropes are 1200±10mm)

Tighten the screw to the ceiling and tighten the wire rope hanger

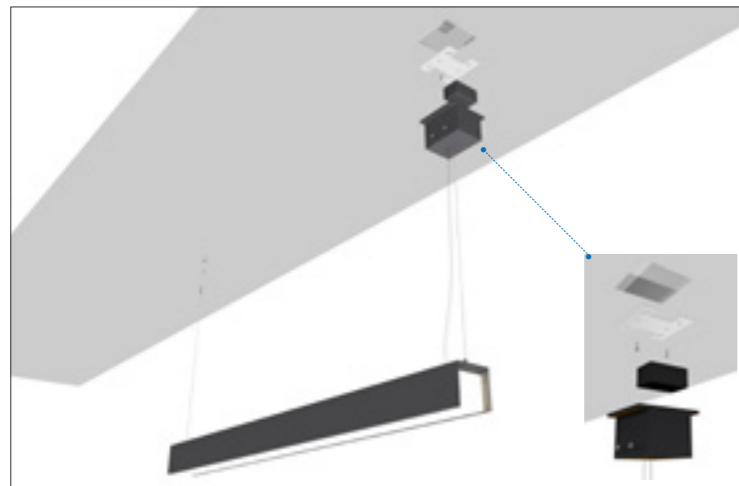

Step 2

Connect the wires by wiring cap, tighten the screws on the mounted fit.

Fix the fixing plate to the embedded box and tighten the screw. Then tighten the screw of the open electrical box.

Note: Power supply should be disconnected and live operation should not be allowed.

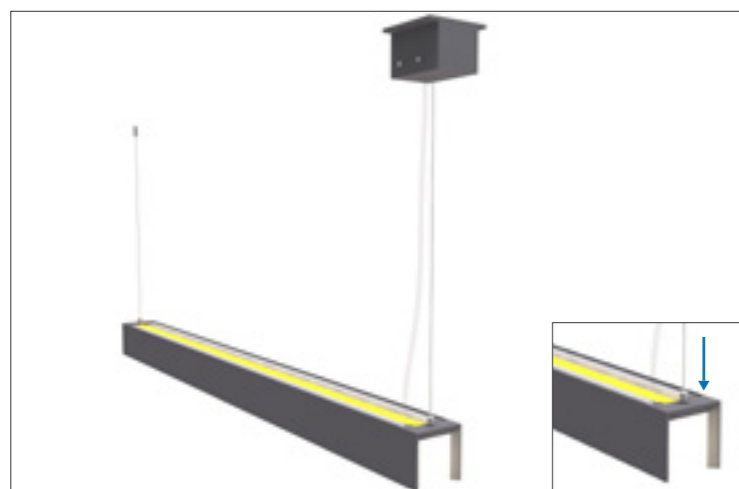
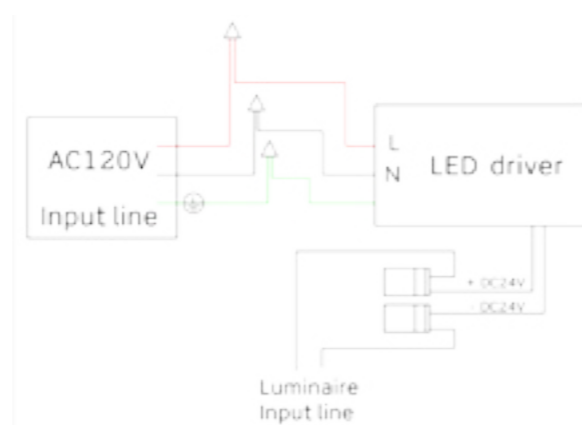

Step 3

Fix the suspending rope on the lamp, turn on the power.

HIGH-PERFORMANCE 2X4 RECESSED LED TROFFER

SPLICING SUSPENDED INSTALLATION

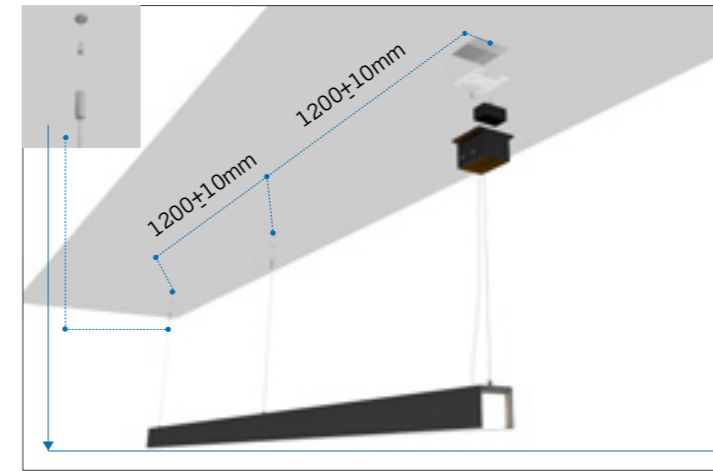

Step 1

Make the wires through the holes of the surface mounted kit, fix the kit on the J-box, attach the fit on the J-box by screws, fix the holders of suspending rope and surface mounted frame on the ceiling (make sure the distance between the 2 ropes are 1200±10mm)

Tighten the screw to the ceiling and tighten the wire rope hanger

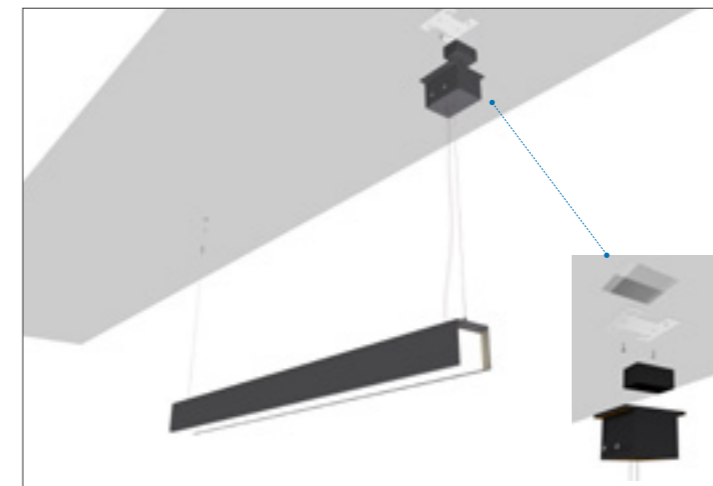

Step 2

Connect the wires by wiring cap, tighten the screws on the mounted fit.

The size of the electrical box varies according to the number of lamps connected in series and the size of the driving brand. Consult the manufacturer for the specific size.

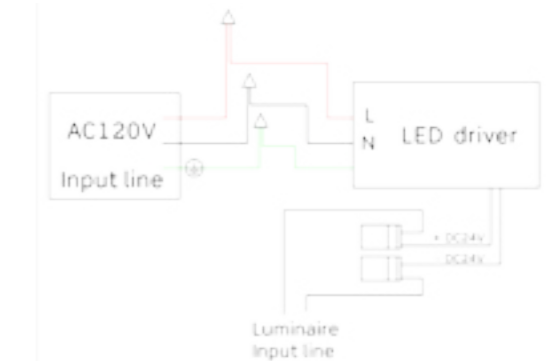

Fix the fixing plate to the embedded box and tighten the screw. Then tighten the screw of the open electrical box.

Note: Power supply should be disconnected and live operation should not be allowed.

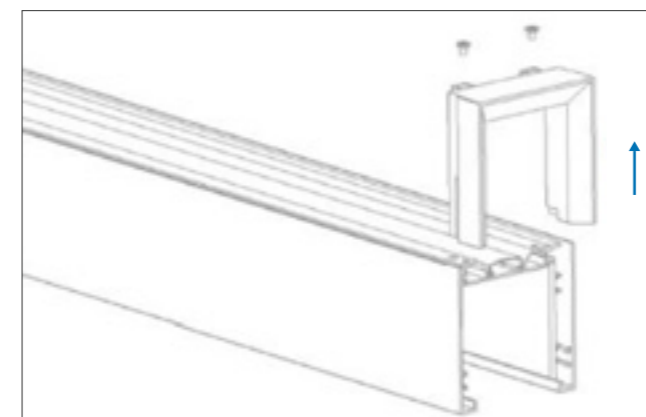

Step 3

Remove one end cap of the lamp

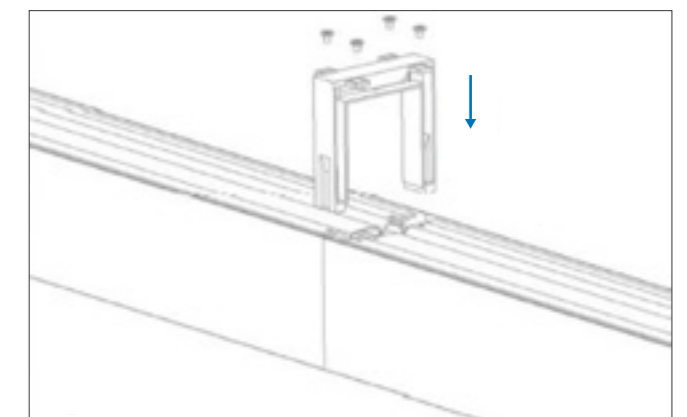

Step 4

Then replace the splicing end cover, and fix and lock the two lights with the splicing end cover when the end cover is removed.



LED TRI-PROOF LIGHT

HIGH PERFORMANCE LED TRI-PROOF LIGHT

LED Tri-proof Light is specifically built to withstand conditions susceptible to water, dust and corrosion impacts. Liteharbor tri-proof luminaires are incredibly durable and long lasting. They are highly resistant to heavy impacts and can withstand temperature variations of up to 40°C.

HIGH PERFORMANCE 2FT LED TRI-PROOF LIGHT



Dustproof
Moisture-Proof
Anti-Corrosion



Emergency system is available.

Power: 20W
Voltage: 120V/277V 120V ~ 277V AC
Frequency: 50/60Hz
Power factor: >0.98
CRI: 80+ /90+
Dimmable: NONE/0-10V/TRIAC
CCT: 2700-6500K
Suitable for wet locations

FEATURES

PLED-2STR is dustproof, moisture-proof and anti-corrosion product, provide high lumen, thin, beautiful appearance, safe and reliable, convenient installation and easy maintenance tri-proof light. This 2 ft. LED ready vapor tight fixture features a reinforced plastic housing and acrylic lens to help keep lamps protected from harsh weather conditions. PLED-2STR is an industrial grade luminaire which is ideal for retail, commercial and industrial applications.

LIGHT SOURCE

Using the energy-saving highlighting 5630 SMD LED light source. Distributed LED array in a variety of lumen output packages. LED color temperature is available in 2700-6500K. Module is replaceable.

MOUNTING

Luminaires may be surface mounted or suspended, individually or in continuous row. Fixtures easily snap together for long continuous rows. The PLED-2STR may be surface mounted or suspended, individually or in continuous row.

DRIVER

Using isolation constant-current driver power, is the guarantee of security, stability and no flicking.

APPLICATION

Suit for the garage, warehouse, basement and car parks and other places to provide general illumination.

LISTING / WARRANTY

ETL listed, conforms to UL Standard 1598 / 8750 and CSA Standard C22.2, Damp location. 5-year limited warranty on LED and Driver.



DIMENSIONS

W : 4 3/4"
H : 3 5/16"



PACKING	CTN Size: 680x400x195mm (6 PCS/CTN)
	Inner Box Size: 665x125x90mm

MOUNTING



Luminaires may be surface mounted or suspended, individually or in continuous row. Fixtures easily snap together for long continuous rows.

ORDERING GUIDE / YOUR PRODUCT CODE

SERIES	VOLTAGE	WATTAGE/LUMEN	MOUNTING	CCT	DIMMING	CUSTOMIZED FUNCTIONS
○ PLED-2STR 2 FT LED Tri-proof Light	○ 120V AC ○ 277V AC ○ 120-277V AC	○ 20W/2000lm	○ Surface Mounted ○ Suspended Mounted ○ Chain	○ 2700K ○ 3000K ○ 3500K ○ 4000K ○ 5000K ○ 6000K ○ 6500K	○ NONE ○ 0-10V Dimming ○ TRIAC Dimming	○ Emergency Backup ○ RGBW ○ Tunable(3000K,4000K,5000K,choose any 2 of them) ○ motion sensor

* Customized Also Available

HIGH PERFORMANCE 4FT LED TRI-PROOF LIGHT



Dustproof
Moisture-Proof
Anti-Corrosion



Emergency system is available.

Power: 40W
Voltage: 120V/277V 120V ~ 277V AC
Frequency: 50/60Hz
Power factor: >0.98
CRI: 80+ /90+
Dimmable: NONE/0-10V/TRIAC
CCT: 2700-6500K
Suitable for wet locations

FEATURES

PLED-4STR is dustproof, moisture-proof and anti-corrosion product, provide high lumen, thin, beautiful appearance, safe and reliable, convenient installation and easy maintenance tri-proof light. This 4 ft. LED ready vapor tight fixture features a reinforced plastic housing and acrylic lens to help keep lamps protected from harsh weather conditions. PLED-4STR is an industrial grade luminaire which is ideal for retail, commercial and industrial applications.

LIGHT SOURCE

Using the energy-saving highlighting 5630 SMD LED light source. Distributed LED array in a variety of lumen output packages. LED color temperature is available in 2700-6500K. Module is replaceable.

MOUNTING

Luminaires may be surface mounted or suspended, individually or in continuous row. Fixtures easily snap together for long continuous rows. The PLED-4STR may be surface mounted or suspended, individually or in continuous row.

DRIVER

Using isolation constant-current driver power, is the guarantee of security, stability and no flicking.

APPLICATION

Suit for the garage, warehouse, basement and car parks and other places to provide general illumination.

LISTING / WARRANTY

ETL listed, conforms to UL Standard 1598 / 8750 and CSA Standard C22.2, Damp location. 5-year limited warranty on LED and Driver.



DIMENSIONS

W : 4 3/4"
H : 3 5/16"



PACKING	CTN Size: 1300x265x235mm (4 PCS/CTN)
	Inner Box Size: 1275x125x110mm

MOUNTING



Luminaires may be surface mounted or suspended, individually or in continuous row. Fixtures easily snap together for long continuous rows.

ORDERING GUIDE / YOUR PRODUCT CODE

SERIES	VOLTAGE	WATTAGE/LUMEN	MOUNTING	CCT	DIMMING	CUSTOMIZED FUNCTIONS
○ PLED-4STR 4 FT LED Tri- proof Light	○ 120V AC ○ 277V AC ○ 120-277V AC	○ 40W/4000lm	○ Surface Mounted ○ Suspended Mounted ○ Chain	○ 2700K ○ 3000K ○ 3500K ○ 4000K ○ 5000K ○ 6000K ○ 6500K	○ NONE ○ 0-10V Dimming ○ TRIAC Dimming	○ Emergency Backup ○ RGBW ○ Tunable(3000K,4000K,5000K,choose any 2 of them) ○ motion sensor

* Customized Also Available

HIGH PERFORMANCE 5FT LED TRI-PROOF LIGHT



Dustproof
Moisture-Proof
Anti-Corrosion



Power: 50W
Voltage: 120V/277V 120V ~ 277V AC
Frequency: 50/60Hz
Power factor: >0.98
CRI: 80+/90+
Dimmable: NONE/0-10V/TRIAC
CCT: 2700-6500K
Suitable for wet locations

Emergency system is available.

FEATURES

PLED-5STR is dustproof, moisture-proof and anti-corrosion product, provide high lumen, thin, beautiful appearance, safe and reliable, convenient installation and easy maintenance tri-proof light. This 5 ft. LED ready vapor tight fixture features a reinforced plastic housing and acrylic lens to help keep lamps protected from harsh weather conditions. PLED-5STR is an industrial grade luminaire which is ideal for retail, commercial and industrial applications.

LIGHT SOURCE

Using the energy-saving highlighting 5630 SMD LED light source. Distributed LED array in a variety of lumen output packages. LED color temperature is available in 2700-6500K. Module is replaceable.

MOUNTING

Luminaires may be surface mounted or suspended, individually or in continuous row. Fixtures easily snap together for long continuous rows. The PLED-5STR may be surface mounted or suspended, individually or in continuous row.

DRIVER

Using isolation constant-current driver power, is the guarantee of security, stability and no flicking.

APPLICATION

Suit for the garage, warehouse, basement and car parks and other places to provide general illumination.

LISTING / WARRANTY

ETL listed, conforms to UL Standard 1598 / 8750 and CSA Standard C22.2, Damp location. 5-year limited warranty on LED and Driver.



DIMENSIONS

W: 4 3/4"
H: 3 5/16"



PACKING

CTN Size: 1605x265x235mm (4 PCS/CTN)
Inner Box Size: 1590x125x110mm

MOUNTING



Luminaires may be surface mounted or suspended, individually or in continuous row. Fixtures easily snap together for long continuous rows.

ORDERING GUIDE / YOUR PRODUCT CODE

SERIES	VOLTAGE	WATTAGE/LUMEN	MOUNTING	CCT	DIMMING	CUSTOMIZED FUNCTIONS
○ PLED-5STR 5 FT LED Tri-proof Light	○ 120V AC ○ 277V AC ○ 120-277V AC	○ 50W/5000lm	○ Surface Mounted ○ Suspended Mounted ○ Chain	○ 2700K ○ 3000K ○ 3500K ○ 4000K ○ 5000K ○ 6000K ○ 6500K	○ NONE ○ 0-10V Dimming ○ TRIAC Dimming	○ Emergency Backup ○ RGBW ○ Tunable(3000K,4000K, 5000K,choose any 2 of them) ○ motion sensor

* Customized Also Available

INSTALLATION INSTRUCTIONS



WARNING: RISK OF SHOCK

- Electric current can cause painful shock or serious injury unless handled properly. For your safety always:
- Turn off electrical power at fuse or circuit breaker box before wiring fixture to the power supply.
 - Turn off the power when you change lamps or perform other maintenance.
 - Ground the fixture to avoid potential electric shocks and to ensure reliable starting.
 - Double-check all connections to be sure they are tight and correct.
 - Wear rubber-soled shoes and work on a sturdy wooden ladder.

This fixture is designed for use in a circuit protected by a fuse or circuit breaker and to be installed in accordance with local electrical codes. If you are unsure about your wiring, consult a qualified electrician or local electrical inspector and check your local electrical code.



WARNING: RISK OF INJURY

- Some metal parts in the fixture may have sharp edges. To prevent cuts and scrapes, wear gloves when handling the parts. Account for small parts and destroy packing material, as these may be hazardous to children. Use flashlight or alternate light source to light work area during installation. Assistance may be required to support fixture during installation. When drilling holes overhead, always wear safety glasses to protect eyes. Fitting and Mounting Hardware Included. (Chain and related hardware not included)

PREPARE FIXTURE FOR INSTALLATION

- Disengage and remove channel cover. Squeeze the catchers to release channel cover.**
- Remove fixture components and parts pack(s).**
- Snap Lamp holders into Respective slots.**
- Install 10 latches onto fixture housing.**
To install latch align latch with latch opening on housing. While gently pressing center of latch, slide latch downward into recessed groves on housing. **See Fig. 1.** Repeat for remaining latches.
- Install Water-Tight Fitting.**
Note: Fixture is supplied with a Water-tight fitting for cable. If power supply is to be connected by conduit or another method, please use appropriate water-tight fitting. Remove nut from small threaded end of fitting. Do not remove washer. Insert small threaded end of fitting into open hole on end of housing. (Washer should be outside of housing. **See Fig. 2** Tighten until secure. Note: Fitting must be secured tightly to housing to eliminate water entering into fixture housing.

Figure 1

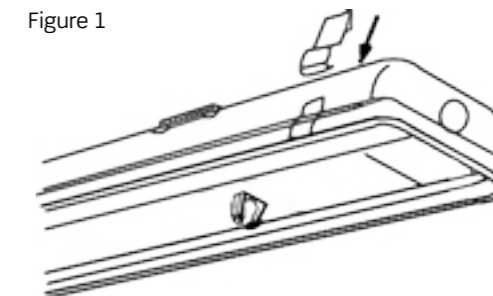

Figure 2

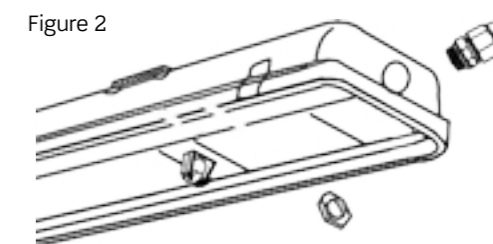
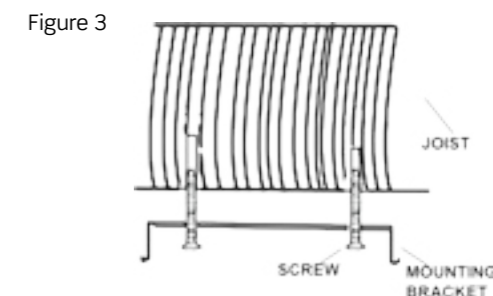

Figure 3



END TO END MOUNTING

Fixture can be End to End (continuous Row) mounted.

If requires End to End mounting- the knockout on opposite end of fixture must be removed and a 27/32" dia. hole must be drilled through plastic housing. To remove knockout - Insert a flat blade screwdriver into small rectangle slot and pry upward to loosen knockout. Grip edge of knockout with pliers and flex back and forth until removed. Additional fittings must be purchased for through wiring.

CEILING/WALL INSTALLATION

If mounting to a metal surface- additional hardware will need to be purchased. Follow Steps 5A to 6A.

- 5A. Mark location for mounting holes. Mounting brackets to be installed 35 1/2" apart on mounting surface (center of bracket to center of bracket). For each bracket, drill 3/32" pilot holes, 1" apart at mounting bracket position.

If drill encounters ceiling joist, drill 3/32" pilot holes in joist for mounting with 11/8" wood screws (included). Insert wood screws through slots on mounting bracket. Tighten screws to secure bracket to mounting surface. **See Fig.3.** Repeat for other mounting bracket. (Go to step 6A).

If drill does not encounter ceiling joist, drill 3/16" holes in mounting surface for mounting with plastic toggle nut and screw. Push plastic toggle nuts into pre-drilled holes. Insert screws through slots on mounting bracket. Push screw into holes until toggle nut expands. **See Fig. 4.** Tighten screws to secure bracket. Repeat for other mounting bracket.

- 6A. Lift Fixture housing to mounting Brackets and snap in place. **See Fig. 5.** Fixture is now secure. (Proceed to step 9)

CHAIN (SUSPENDED) MOUNTING

(Support arm for chain mounting is included - chain and related hardware is not included and must be purchased separately.) Follow steps 5B to 8B.

- 5B. Mark location for two mounting holes 35 1/2" apart on mounting surface and secure chain to mounting surface.
- 6B. Install wire support arms to mounting brackets by snapping into holes. **See Fig. 5.**
- 7B. Snap mounting bracket onto back of fixture housing. **See Fig.6.**
- 8B. Secure chain to fixture wire support arms. Adjust to desired mounting height.

WIRING AND FIXTURE OPERATION

CAUTION: CONNECT FIXTURE TO SUPPLY WIRES RATED FOR AT LEAST 90°C (194°F). DO NOT USE FIXTURE ON DIMMING CIRCUITS.

9. Feed supply wire through fitting. Make sure supply wire is long enough to make connection. **See Fig.8.**
10. Make wire connections by connecting bare copper or green supply wire to green fixture wire with wire nut. Connect black supply wire to black fixture and white supply wire to white fixture wire with wire nut.
11. Tighten external nut on water-tight fitting to seal wire entering into fixture. **See Fig.8.** Using an adjustable wrench, tighten nut until fitting bushing is sealed completely around cable.

For proper connection- place wire nut over wires, twist clockwise until tight.

12. Bundle wires together and position inside wire way.
13. Position metal cover onto fixture opening. Make sure wires are not pinched between plastic housing and metal cover. Lift the metal cover, let the catchers through the slots, and lock. **See Fig.9**

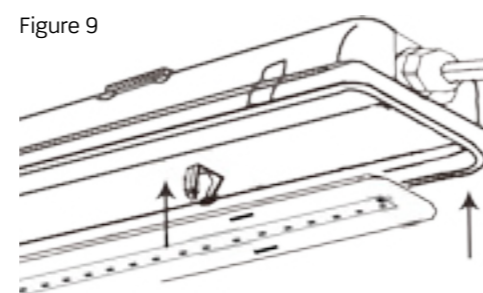
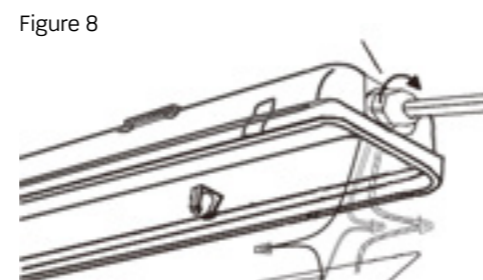
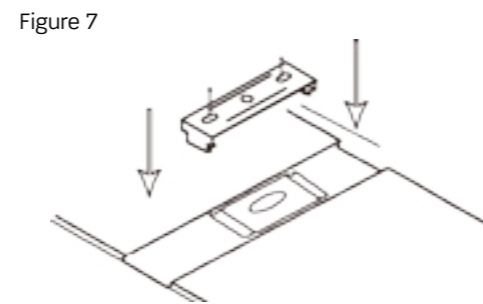
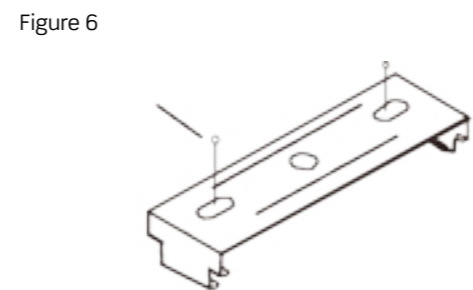
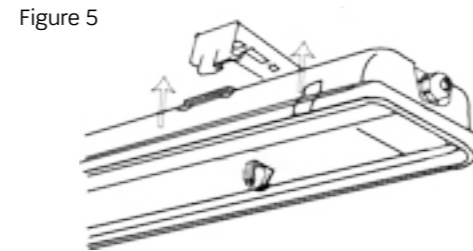
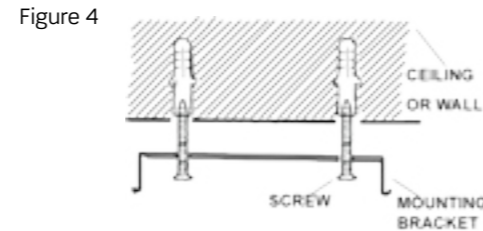

INSTALLING LENS

14. To install lens- position lens onto fixture housing. **See Fig.10.** Edge of lens should be positioned in gasket area on the perimeter of housing. Slide latches over edge of lens. When latch is fully engaged it will produce a "snap" sound. Repeat for all remaining latches.
15. Installation is Complete. Turn on electricity at fuse or circuit breaker box.

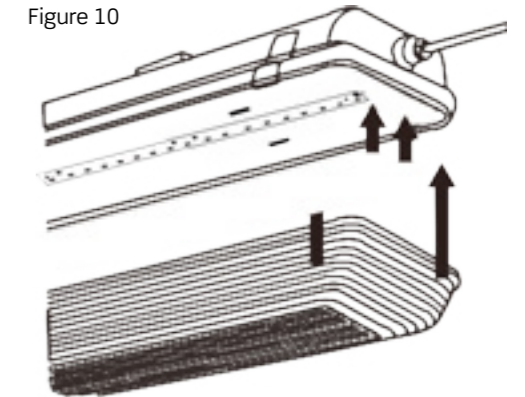

FOR OPENING FIXTURE:

To open latches, push the latch outwards to disengage latch. **See Fig. 11**

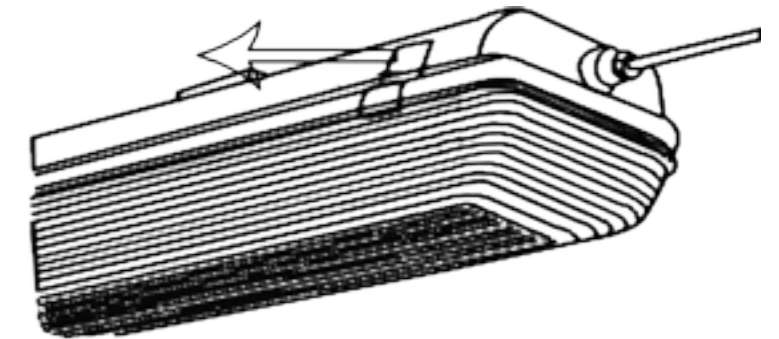

Before cleaning- turn off power. For best results, plastic panels should be washed with soap or mild detergent. Rinse with clear water and allow to air dry.

LED LIGHTING TROUBLESHOOTING GUIDE

LED lighting installations provide service for many years with little or no maintenance except for routine cleaning and re-lamping. If a malfunction does occur, use the guide below to diagnose and correct the problem. If further assistance is required, contact consumer products Customer Service.

If fixture "hums":

1. Verify LED driver is securely fastened to housing.
2. Verify fixture is grounded properly.
3. Allow fixture to remain on continuously for 48 to 72 hours. This allows for proper "seasoning" of the LED driver.

If LED modules will not operate or flicker:

1. Make sure all LED modules are properly connected.
2. Make sure all connection is correct, Red wire connects to "+", and Black wire connects to "-".
3. Verify that the fixture is wired properly.



LED RUNNING MAN SIGNAGE

Liteharbor Running Man LED Signs feature an attractive design that is ideal for commercial and institutional installations. The slim profile of this sign blends perfectly with current interiors.



NOTES:

- LED Running Man Signage Options
- Customized Service Consult Our Factory



Running Man Available(120-347V)



LED EXIT SIGN

LED Exit Signs use energy-efficient LEDs and are available with red or green colors, lettering or running man images, clearly marking exit doors around the facility. Liteharbor offers a wide range of exit sign designs for you to choose.

LED EMERGENCY LIGHT

EXL014-R



FEATURES

This is a smart emergency lighting product independently developed by Liteharbor, it is mainly used in fire emergency lighting and evacuation instructions, meets the UL standards. The illumination angle of each lamp can be adjusted, which can be rotated by 358° and adjusted vertically by 0~90°. Safety exit channel indicator sign is clear.

FUNCTIONS

Dual voltage input: 90-347 VAC, 50/60 Hz
With multiple functions such as emergency conversion, 12 hour timed charging, analog power failure, 30 or 360 day timed discharge (self test), signal filling simulation test, fault indication, fault alarm, battery open / short circuit detection, load source open circuit / short circuit detection, instant trip delay timing charging. Microcomputer intelligent control, easy to operate, only one function button.
Long life LED light source.
Fully recharged in 24 hours.
Solid-state switching.
Overload/short Circuit protection.
Test switch/power indicator light.

INDICATOR

High impact acrylic panel.
Available with red or green letters.
Single and double sided lenses included.
Clear, mirror insert and white insert options included.
Field installed and NFPA 101 compliant chevron directional indicators included.
No Tools required for "snap in" installation.

OTHER INFO

Operating Temperature: 32°F to 104°F (0°C to 40°C).
Mounting: Recessed/Ceiling Mounted
Single/double face letter with exit sign or running man.

BATTERY

Sealed nickel cadmium.
Maintenance free.
24 hour full recharge time.

INSTALLATION SHELL

Recessed installation shell: Made of galvanized sheet, with hanger bar installation.

Running Man Available(120-347V)



WHOLE LAMP PARAMETER

Wattage	Emergency Power	Voltage	Frequency	Emergency Time
2W	6W	90-347V AC	50/60 Hz	≥90 mins

SINGLE LAMP EMERGENCY LIGHTING PARAMETERS

Wattage	Voltage	CCT	CRI	Luminous Flux	Type
2W Max.	12V DC	3000K	80/90+	180lm	SMD

BATTERY PARAMETERS

Battery Type	Voltage	Capacity
NiCad	12V DC	3000m Ah

DIMENSIONS

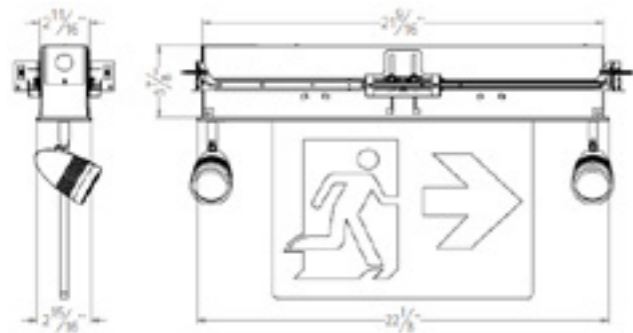

LISTING / WARRANTY

ETL listed to US and Canadian standards for damp location W/Feed through.
3 Years Limited Warranty.



ORDERING GUIDE / YOUR PRODUCT CODE

SERIES	LUMEN	CCT	CRI	INPUT VOLTAGE	FINISH
○ EXL014	○ 180 Lm	○ 2700K	○ 80+	○ 90-347V	○ White
○ Recessed Mounted			○ 90+		○ Black
○ LED Emergency Light					

* Customized Also Available

Letter Ordering Guide

FACE QTY&SIGN	LETTER COLOR
○ Single Face with Exit	○ Red
○ Double Face with Exit	○ Green
○ Single Face with Running Man	
○ Double face with Running Man	

LED EMERGENCY LIGHT

EXL014-F

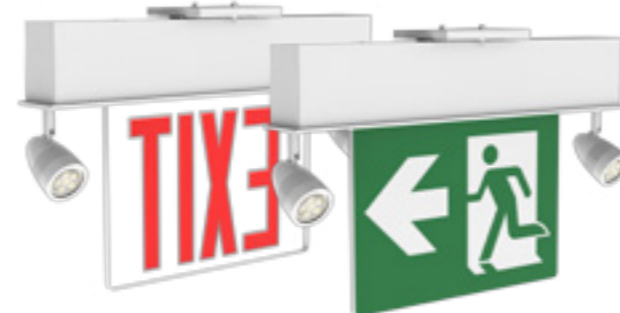

FEATURES

This is a smart emergency lighting product independently developed by Liteharbor, it is mainly used in fire emergency lighting and evacuation instructions, meets the UL standards. The illumination angle of each lamp can be adjusted, which can be rotated by 358° and adjusted vertically by 0~90°. Safety exit channel indicator sign is clear.

FUNCTIONS

Dual voltage input: 90-347 VAC, 50/60 Hz
With multiple functions such as emergency conversion, 12 hour timed charging, analog power failure, 30 or 360 day timed discharge (self test), signal filling simulation test, fault indication, fault alarm, battery open / short circuit detection, load source open circuit / short circuit detection, instant trip delay timing charging. Microcomputer intelligent control, easy to operate, only one function button.
Long life LED light source.
Fully recharged in 24 hours.
Solid-state switching.
Overload/short Circuit protection.
Test switch/power indicator light.

INDICATOR

High impact acrylic panel.
Available with red or green letters.
Single and double sided lenses included.
Clear, mirror insert and white insert options included.
Field installed and NFPA 101 compliant chevron directional indicators included.
No Tools required for "snap in" installation.

OTHER INFO

Operating Temperature: 32°F to 104°F (0°C to 40°C).
Mounting: Recessed/Ceiling Mounted
Single/double face letter with exit sign or running man.

BATTERY

Sealed nickel cadmium.
Maintenance free.
24 hour full recharge time.

INSTALLATION SHELL

Ceiling installation shell: Iron shell sprayed, anti-corrosion and anti-rust, can be made of white, black, gray.

Running Man Available(120-347V)



WHOLE LAMP PARAMETER

Wattage	Emergency Power	Voltage	Frequency	Emergency Time
2W	6W	90-347V AC	50/60 Hz	≥90 mins

SINGLE LAMP EMERGENCY LIGHTING PARAMETERS

Wattage	Voltage	CCT	CRI	Luminous Flux	Type
2W Max.	12V DC	3000K	80/90+	180lm	SMD

BATTERY PARAMETERS

Battery Type	Voltage	Capacity
NiCad	12V DC	3000m Ah

DIMENSIONS

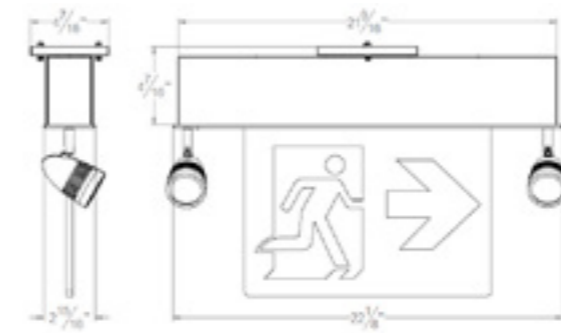

LISTING / WARRANTY

ETL listed to US and Canadian standards for damp location W/Feed through.
3 Years Limited Warranty.



ORDERING GUIDE / YOUR PRODUCT CODE

SERIES	LUMEN	CCT	CRI	INPUT VOLTAGE	FINISH
○ EXL014	○ 180 Lm	○ 2700K	○ 80+	○ 90-347V	○ White
○ Ceiling Mounted			○ 90+		○ Black
○ LED Emergency Light					

* Customized Also Available

Letter Ordering Guide

FACE QTY&SIGN	LETTER COLOR
○ Single Face with Exit	○ Red
○ Double Face with Exit	○ Green
○ Single Face with Running Man	
○ Double face with Running Man	

MULTIFUNCTIONAL LED EXIT SIGN

EXL015



DESCRIPTION

Cold-rolled steel material or heavy duty 20 gauge steel or aluminum housing
 Supplied standard with two pictogram films per face, for direction selection
 AC-only or self-powered models.
 120V/347V AC operation.
 Long-life, energy-saving LED technology.
 Canopy mounting system designed specifically for ease of installation.
 Universal knockout chevrons.
 The face plate can be rotated 90°.
 30 days and 365 days self-diagnostics are standard.

MOUNTING

Wall, side, ceiling or recessed mounting
 Key hole slots are stamped into the backplate

ELECTRICAL

Dual voltage input 120-347V AC, 60 Hz
 LED Light Source

BATTERY

The sign is designed with a maintenance free Self-Powered model delivers
 90 minutes min. of back-up lighting.
 Recharge time of the battery is 24 hours.



DIMENSIONS

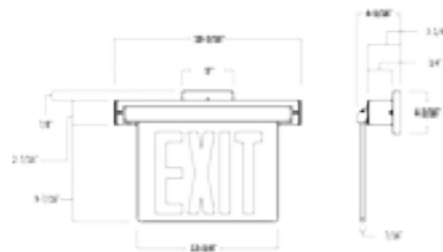

Wattage	1w(DC)
Light Source	LED
Input Voltage	120-347V
Material	Aluminum+Acrylic
Recharge Time	24 Hours
Emergency Time	90 Minutes

Running Man Available(120-347V)



ORDERING GUIDE / YOUR PRODUCT CODE

SERIES	SIGN	FACE Q'TY	BATTERY BACKUP	HOUSING COLOR	LETTER COLORS
<input type="radio"/> EXL015	<input type="radio"/> Exit Sign	<input type="radio"/> Single Face	<input type="radio"/> Battery Backup	<input type="radio"/> White	<input type="radio"/> Red
<input type="radio"/> Exit Light	<input type="radio"/> Running Man	<input type="radio"/> Double Face	<input type="radio"/> AC Only	<input type="radio"/> Satin Nickel	<input type="radio"/> Green
				<input type="radio"/> Brushed Aluminum	

ARROW DIRECTION					
<input type="radio"/> No indicators	<input type="radio"/> Right indicator	<input type="radio"/> Down indicator	<input type="radio"/> 45° down right	<input type="radio"/> 45° down left	
<input type="radio"/> Left indicator	<input type="radio"/> Up indicator	<input type="radio"/> 45° up right	<input type="radio"/> 45° up left		

* Customized Also Available

LISTING / WARRANTY

ETL listed to US and Canadian standards for damp location W/Feed through.
 3 Years Limited Warranty.



Liteharbor Harbor of Light!

LED EXIT SIGN

EXL009



DESCRIPTION

Universal single or double face
 Energy saving LED lamps
 Heavy duty 20 gauge steel housing
 Durable white powder coated finish other finish please consult factory
 Etched, clear acrylic edge-lite face plate
 Universally surface mounted, recessed mounted, pendant mounted all are available
 Red or green letter colors

ELECTRICAL

Dual voltage input 110-277V AC 60HZ
 Solid-state voltage limited charger
 Solid-state switching
 Brownout circuit
 Low voltage disconnected
 Overload/short circuit protection
 Test switch/power indicator light

BATTERY

Sealed Nickel Cadmium (Self-Powered exits only)
 Maintenance-Free, long life
 Full recharge time 24 hours (max)



Wattage	1w(DC)
Light Source	LED
Input Voltage	120-347V
Material	Steel+Acrylic
Recharge Time	24 Hours
Emergency Time	90 Minutes

Running Man Available(120-347V)



DIMENSIONS

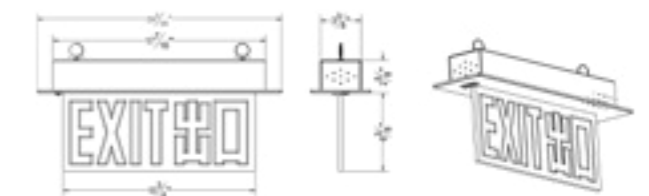

ORDERING GUIDE / YOUR PRODUCT CODE

SERIES	SIGN	FACE Q'TY	BATTERY BACKUP	HOUSING COLOR	LETTER COLORS
<input type="radio"/> EXL009	<input type="radio"/> Exit Sign	<input type="radio"/> Single Face	<input type="radio"/> Battery Backup	<input type="radio"/> White	<input type="radio"/> Red
<input type="radio"/> Exit sign	<input type="radio"/> Running Man	<input type="radio"/> Double Face	<input type="radio"/> AC Only	<input type="radio"/> Satin Nickel	<input type="radio"/> Green

MOUNTING		
<input type="radio"/> Surface Mounted	<input type="radio"/> Recessed Mounted	<input type="radio"/> Pedant Mounted

* Customized Also Available

LISTING / WARRANTY

ETL listed to US and Canadian standards for damp location W/Feed through.
 3 Years Limited Warranty.



E-mail:info@liteharbor.com

LED EXIT SIGN

EXL010



DESCRIPTION

Slim-profile extruded aluminum housing
Extruded acrylic panel with pictogram legend
AC-only or self-powered models.
Long-life, energy-saving LED technology.
Power-on LED indicator Light and push-to-test switch.
Universal canopy available.
Universal knockout chevrons.

MOUNTING

Universal (wall, side or ceiling mounting)
Key hole slots are stamped into the backplate

ELECTRICAL

Universal 2-wire AC input voltage of 120 to 347V AC at less than 3Watts and universal 2-wire DC input voltage from 6 to 24V DC at 1-2 Watt consumption for single and double face signs white light-emitting diodes even illumination in normal and emergency operation

BATTERY

The sign is designed with a maintenance free Self-Powered model delivers 90 minutes min. of back-up lighting.
Recharge time of the battery is 24 hours.



Wattage	1w(DC)
Light Source	LED
Input Voltage	120-347V
Material	Aluminum+Acrylic
Recharge Time	24 Hours
Emergency Time	90 Minutes

Running Man Available(120-347V)



DIMENSIONS

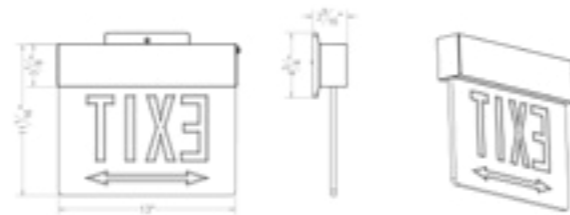

ORDERING GUIDE / YOUR PRODUCT CODE

SERIES	SIGN	FACE Q'TY	BATTERY BACKUP	HOUSING COLOR	LETTER COLORS
<input type="radio"/> EXL005	<input type="radio"/> Exit Sign	<input type="radio"/> Single Face	<input type="radio"/> Battery Backup	<input type="radio"/> White	<input type="radio"/> Red
<input type="radio"/> Exit sign	<input type="radio"/> Running Man	<input type="radio"/> Double Face	<input type="radio"/> AC Only	<input type="radio"/> Satin Nickel	<input type="radio"/> Green

ARROW DIRECTION

- No indicators
- Right indicator
- Down indicator
- 45° down right
- 45° down left
- Left indicator
- Up indicator
- 45° up right
- 45° up left

* Customized Also Available

LISTING / WARRANTY

ETL listed to US and Canadian standards for damp location W/Feed through.
3 Years Limited Warranty.



Liteharbor Harbor of Light!

LED EXIT SIGN

EXL011



DESCRIPTION

Cold-rolled steel material
Supplied standard with two pictogram films per face, for direction selection
AC-only or self-powered models.
120V/347V AC operation.
Long-life, energy-saving LED technology.
Canopy mounting system designed specifically for easy of installation
Universal knockout chevrons.

MOUNTING

Universal (wall, side or ceiling mounting)
Key hole slots are stamped into the backplate

ELECTRICAL

Universal 2-wire AC input voltage of 120 to 347V AC at less than 3Watts and universal 2-wire DC input voltage from 6 to 24V DC at 1-2 Watt consumption for single and double face signs white light-emitting diodes even illumination in normal and emergency operation

BATTERY

The sign is designed with a maintenance free Self-Powered model delivers 90 minutes min. of back-up lighting.
Recharge time of the battery is 24 hours.



Wattage	1w(DC)
Light Source	LED
Input Voltage	120-347V
Material	Steel
Recharge Time	24 Hours
Emergency Time	90 Minutes

Running Man Available(120-347V)



DIMENSIONS

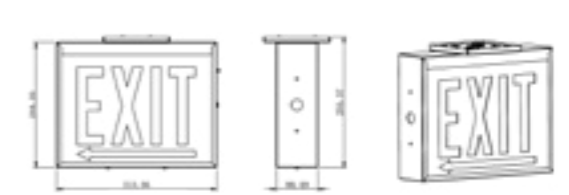

ORDERING GUIDE / YOUR PRODUCT CODE

SERIES	SIGN	FACE Q'TY	BATTERY BACKUP	HOUSING COLOR	LETTER COLORS
<input type="radio"/> EXL011	<input type="radio"/> Exit Sign	<input type="radio"/> Single Face	<input type="radio"/> Battery Backup	<input type="radio"/> White	<input type="radio"/> Red
<input type="radio"/> Exit sign	<input type="radio"/> Running Man	<input type="radio"/> Double Face	<input type="radio"/> AC Only	<input type="radio"/> Satin Nickel	<input type="radio"/> Green

ARROW DIRECTION

- No indicators
- Right indicator
- Down indicator
- 45° down right
- 45° down left
- Left indicator
- Up indicator
- 45° up right
- 45° up left

* Customized Also Available

LISTING / WARRANTY

ETL listed to US and Canadian standards for damp location W/Feed through.
3 Years Limited Warranty.



E-mail:info@liteharbor.com

RECESSED MOUNTED LED EXIT EMERGENCY LIGHT

EXL012



DESCRIPTION

Slim-profile extruded aluminum housing
Extruded acrylic panel with pictogram legend
AC-only or self-powered models.
120V/347V AC operation.
Long-life, energy-saving LED technology.

MOUNTING

Ceiling Recessed Mounting

ELECTRICAL

Universal 2-wire AC input voltage of 120 to 347VAC at less than 3Watts and universal 2-wire DC input voltage from 6 to 24VDC at 1-2 Watt consumption for single and double face signs white light-emitting diodes even illumination in normal and emergency operation

BATTERY

The sign is designed with a maintenance free Self-Powered model delivers 90 minutes min. of back-up lighting.
Recharge time of the battery is 24 hours.



Wattage	1w(DC)
Light Source	LED
Input Voltage	120-347V
Material	Aluminum+Acrylic
Recharge Time	24 Hours
Emergency Time	90 Minutes

Running Man Available(120-347V)



DIMENSIONS

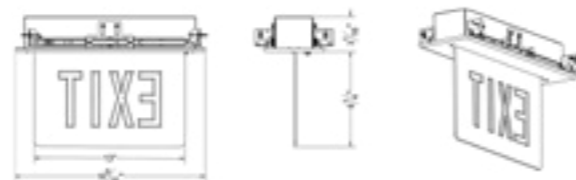

ORDERING GUIDE / YOUR PRODUCT CODE

SERIES	SIGN	FACE Q'TY	BATTERY BACKUP	HOUSING COLOR	LETTER COLORS
<input type="radio"/> EXL012	<input type="radio"/> Exit Sign	<input type="radio"/> Single Face	<input type="radio"/> Battery Backup	<input type="radio"/> White	<input type="radio"/> Red
	<input type="radio"/> Exit sign	<input type="radio"/> Double Face	<input type="radio"/> AC Only	<input type="radio"/> Satin Nickel	<input type="radio"/> Green

ARROW DIRECTION

- | | | | | |
|--------------------------------------|---------------------------------------|--------------------------------------|--------------------------------------|-------------------------------------|
| <input type="radio"/> No indicators | <input type="radio"/> Right indicator | <input type="radio"/> Down indicator | <input type="radio"/> 45° down right | <input type="radio"/> 45° down left |
| <input type="radio"/> Left indicator | <input type="radio"/> Up indicator | <input type="radio"/> 45° up right | <input type="radio"/> 45° up left | |

* Customized Also Available

LISTING / WARRANTY

ETL listed to US and Canadian standards for damp location W/Feed through.
3 Years Limited Warranty.



Liteharbor Harbor of Light!

LED ELEVATOR SIGN

EXL012-EL



DESCRIPTION

Slim-profile extruded aluminum housing
Extruded acrylic panel with pictogram legend
AC-only or self-powered models.
120V/347V AC operation.
Long-life, energy-saving LED technology.
Universal canopy available.
Universal knockout chevrons.

MOUNTING

Ceiling Recessed Mounting

ELECTRICAL

Universal 2-wire AC input voltage of 120 to 347V AC at less than 3Watts and universal 2-wire DC input voltage from 6 to 24V DC at 1-2 Watt consumption for single and double face signs white light-emitting diodes even illumination in normal and emergency operation.

BATTERY

The sign is designed with a maintenance free Self-Powered model delivers 90 minutes min. of back-up lighting.
Recharge time of the battery is 24 hours.



Wattage	1w(DC)
Light Source	LED
Input Voltage	120-347V
Material	Aluminum+Acrylic
Recharge Time	24 Hours
Emergency Time	90 Minutes

Running Man Available(120-347V)



DIMENSIONS



ORDERING GUIDE / YOUR PRODUCT CODE

SERIES	SIGN	FACE Q'TY	BATTERY BACKUP	HOUSING COLOR	LETTER COLORS
<input type="radio"/> EXL012-EL	<input type="radio"/> Exit Sign	<input type="radio"/> Single Face	<input type="radio"/> Battery Backup	<input type="radio"/> White	<input type="radio"/> Red
	<input type="radio"/> Exit sign	<input type="radio"/> Double Face	<input type="radio"/> AC Only	<input type="radio"/> Satin Nickel	<input type="radio"/> Green

ARROW DIRECTION

- | | | | | |
|--------------------------------------|---------------------------------------|--------------------------------------|--------------------------------------|-------------------------------------|
| <input type="radio"/> No indicators | <input type="radio"/> Right indicator | <input type="radio"/> Down indicator | <input type="radio"/> 45° down right | <input type="radio"/> 45° down left |
| <input type="radio"/> Left indicator | <input type="radio"/> Up indicator | <input type="radio"/> 45° up right | <input type="radio"/> 45° up left | |

* Customized Also Available

LISTING / WARRANTY

ETL listed to US and Canadian standards for damp location W/Feed through.
3 Years Limited Warranty.



E-mail:info@liteharbor.com

LED EXIT SIGN

EXL013



DESCRIPTION

Cold-rolled steel material
 Supplied standard with two pictogram films per face, for direction selection
 AC-only or self-powered models.
 120V/347V AC operation.
 Long-life, energy-saving LED technology.
 Canopy mounting system designed specifically for ease installation
 Universal knockout chevrons.

MOUNTING

Universal (wall, side or ceiling mounting)
 Key hole slots are stamped into the backplate

ELECTRICAL

Universal 2-wire AC input voltage of 120 to 347V AC at less than 3Watts and universal 2-wire DC input voltage from 6 to 24V DC at 1-2 Watt consumption for single and double face signs white light-emitting diodes even illumination in normal and emergency operation

BATTERY

The sign is designed with a maintenance free Self-Powered model delivers 90 minutes min. of back-up lighting.
 Recharge time of the battery is 24 hours.

Wattage	1w(DC)
Light Source	LED
Input Voltage	120-347V
Material	Steel
Recharge Time	24 Hours
Emergency Time	90 Minutes



DIMENSIONS

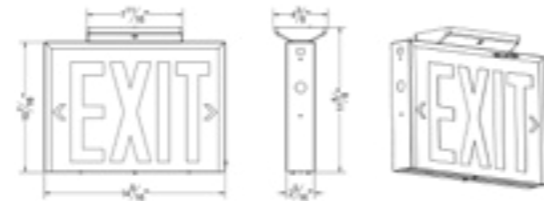

Running Man Available(120-347V)



ORDERING GUIDE / YOUR PRODUCT CODE

SERIES	SIGN	FACE Q'TY	BATTERY BACKUP	HOUSING COLOR	LETTER COLORS
<input type="radio"/> EXL013	<input type="radio"/> Exit Sign	<input type="radio"/> Single Face	<input type="radio"/> Battery Backup	<input type="radio"/> White	<input type="radio"/> Red
<input type="radio"/> Exit sign	<input type="radio"/> Running Man	<input type="radio"/> Double Face	<input type="radio"/> AC Only	<input type="radio"/> Satin Nickel	<input type="radio"/> Green

ARROW DIRECTION

- | | | | | |
|--------------------------------------|---------------------------------------|--------------------------------------|--------------------------------------|-------------------------------------|
| <input type="radio"/> No indicators | <input type="radio"/> Right indicator | <input type="radio"/> Down indicator | <input type="radio"/> 45° down right | <input type="radio"/> 45° down left |
| <input type="radio"/> Left indicator | <input type="radio"/> Up indicator | <input type="radio"/> 45° up right | <input type="radio"/> 45° up left | |

* Customized Also Available

LISTING / WARRANTY

ETL listed to US and Canadian standards for damp location W/Feed through.
 3 Years Limited Warranty.



LED EMERGENCY LIGHT

LED Emergency Lights are designed to provide sufficient lighting during an emergency. Liteharbor offers cost-effective and energy efficient emergency lights to meet a variety of applications, incorporating a line of all LED solutions for added longevity.

LED EMERGENCY LIGHT

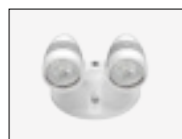
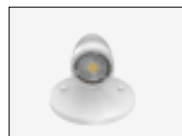

EML213-NC



DESCRIPTION

The product is our company's own design of intelligent mainly used in fire emergency and evacuation instructions, in line with UL standards. with emergency conversion function, 12 hours timer charging, simulated blackout, 30 days, 360 days of self diagnostic testing standard, signal filling simulation test, fault indication, fault alarm, battery open circuit, short circuit detection, load light source open circuit, short circuit detection, instantaneous delay time delay charging and other functions. microcomputer intelligent control, simple operation, only one function key.

FEATURES

Emergency conversion function
12 hours timing charging
Simulated blackout.
Fault indication function
Fault alarm function
Self diagnostic testing standard
Battery Over-discharge Protection function
Instantaneous trip, time delay timing
Can add $2 \leq N \leq 6$ lamps.

BATTERY PARAMETERS

Body Material: Heavy duty 20 gauge steel housing
Hazardous Rating: Class 1 Division 2
Hazardous Rating Group: A B C D
Finish: White/Black/Gray
Light Source Lamps: LED
Mounting: Back Mount
Wet Location Rated: YES
Indoor: YES

LED ENGINE

Input Voltage: 12V
Color Temperature: 3000K
Luminous Flux: 180lm
Light Source: SMD



DIMENSIONS

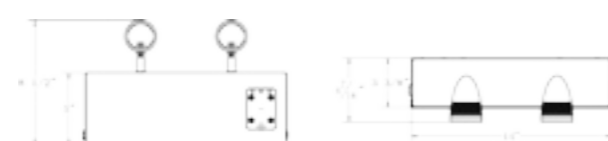

LISTING / WARRANTY

ETL listed to US and Canadian standards for damp location W/Feed through.
3 Years Limited Warranty.



LED EMERGENCY LIGHT

WIRING DIAGRAM

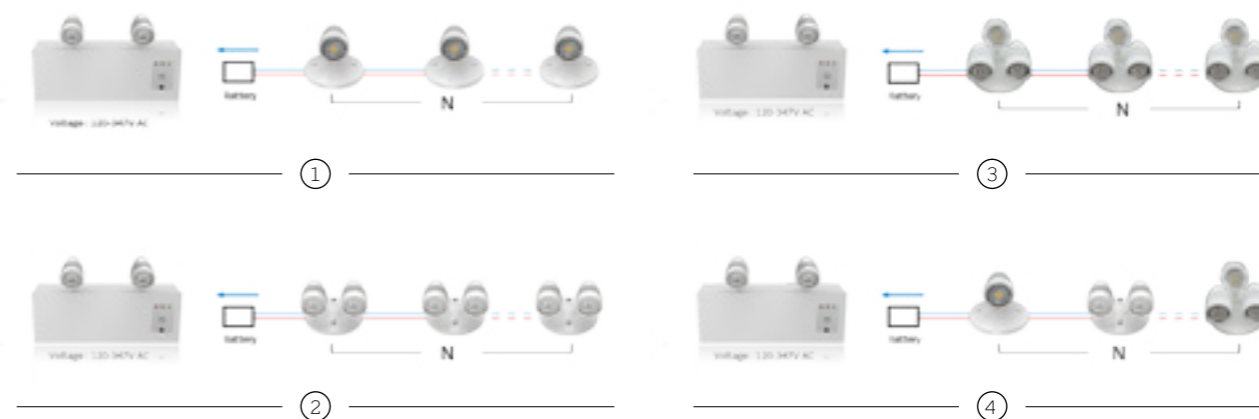

N is the quantities of lamp (not the lamp modules quantities, is the bullet head quantities, including the bullet head on the battery box)

PACKING



- Inner Box:
260X94X225MM

- Outer Carton:
595X275X250MM

- 6 PCS/CTN

- Inner Box:
132X132X125MM

- Outer Carton:
550X415X275MM

- 24 PCS/CTN

- Inner Box:
145X132X110MM

- Outer Carton:
550X455X245MM

- 24 PCS/CTN

- Inner Box:
170X130X125MM

- Outer Carton:
410X355X275MM

- 12 PCS/CTN

ORDERING GUIDE / YOUR PRODUCT CODE

SERIES	BATTERY	HOUSING COLOR
<input type="radio"/> EML213-NC N means the lamp quantities	<input type="radio"/> AC Only <input type="radio"/> Battery Backup	<input type="radio"/> White <input type="radio"/> Satin Nickel <input type="radio"/> Gray

* Customized Also Available



BULLET HEADS DESIGN EMERGENCY LIGHT

EML209



HOUSING

Completely self-contained, fully automatic operation.
 Compact low-profile design in neutral finish.
 Universal mounting plate w/Quick Connect for rapid installation.
 Push-to-test switch.
 6/12-Volt. pure lead maintenance-free battery.
 Environmentally-coated solid state charger.
 Automatic low voltage disconnect (LVD).
 Universal transformer for 120 or 277V AC.
 20 gauge steel housing
 Charge rate/power-on LED indicator light.
 Damp location listed.
 Operation time-90 minutes.
 LED 2*3W max. for DC Mode

HOUSING COLOUR

WH / BK

BATTERY

Lead-acid Battery, Maintenance-free, Long-Life
 Full Recharge Time is 24hrs (max.)



Power
2x3W Max



Voltage
120-347VAC



Mounting
Back Mount



Body Material
Steel Plate/Aluminum



Emergency Time
90 Minutes

DIMENSIONS

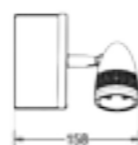
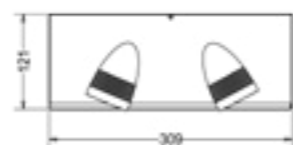

Battery Type	Lead-acid Battery
Power	LED 2*3W max
Voltage	120-347V
Frequency	50/60Hz
Power Factor	>0.98
Emergency Time	Operation time-90 minutes

ORDERING GUIDE / YOUR PRODUCT CODE

SERIES	WATTAGE	BATTERY BACKUP	HOUSING COLOR
<input type="radio"/> EML209 Emergency Light	<input type="radio"/> 1W/Lamp	<input type="radio"/> Battery Backup <input type="radio"/> AC Only	<input type="radio"/> White <input type="radio"/> Satin Nickel <input type="radio"/> Gray

* Customized Also Available

LISTING / WARRANTY

ETL listed to US and Canadian standards for damp location W/Feed through.
 3 Years Limited Warranty.



LED EXIT EMERGENCY LIGHT COMBO

LED Emergency Exit Light Combo is an essential element for any building construction or remodeling project. Liteharbor offers a wide range of exit and emergency lamps. Different color and different letter options also can be customized by Liteharbor factory.

RUNNING MAN EMERGENCY EXIT SIGN COMBO

XML209



Wattage of recharge	1W
Wattage of discharge	3W
Light Source	LED
Input Voltage	120-347V
Material	Steel
Recharge Time	24 Hours
Emergency Time	90 Minutes

Running Man Available(120-347V)



DESCRIPTION

20 Gauge steel housing
 AC-only or self-powered models.
 Long-life, energy-saving LED technology.
 Power-on LED indicator Light and push-to-test switch.
 Comes standard with two pictogram films per face, for direction selection
 Low volt battery disconnection-preventing deep discharge damage to the battery.
 Universal canopy available.
 Universal knockout chevrons.
 Innovative, snap-together design allows for fast installation

MOUNTING

Universal (wall, side or ceiling mounting)
 Key hole slots are stamped into the backplate

LAMPS

LED 2x3W Max.

BATTERY

Lithium battery(6v 4.5Ah)
 The sign is designed with a maintenance free
 Self-Powered model delivers standard two hours of back-up lighting
 Recharge time of the battery is 24 hours.



DIMENSIONS

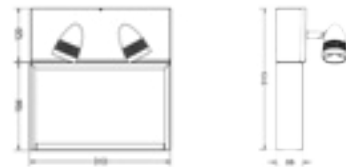

ORDERING GUIDE / YOUR PRODUCT CODE



SERIES	SIGN	FACE Q'TY	BATTERY BACKUP	HOUSING COLOR	LETTER COLORS
<input type="radio"/> XML209 Exit Combo	<input type="radio"/> Exit Sign <input type="radio"/> Running Man	<input type="radio"/> Single Face <input type="radio"/> Double Face	<input type="radio"/> Battery Backup <input type="radio"/> AC Only	<input type="radio"/> White <input type="radio"/> Satin Nickel	<input type="radio"/> Red <input type="radio"/> Green

ARROW DIRECTION					
<input type="radio"/> No indicators	<input type="radio"/> Right indicator	<input type="radio"/> Down indicator	<input type="radio"/> 45° down right	<input type="radio"/> 45° down left	
<input type="radio"/> Left indicator	<input type="radio"/> Up indicator	<input type="radio"/> 45° up right	<input type="radio"/> 45° up left		

* Customized Also Available

LISTING / WARRANTY

ETL listed to US and Canadian standards for damp location W/Feed through.
 3 Years Limited Warranty.





LED TROFFER

Liteharbor LED Troffer Series is designed for commercial applications. These lights are set recessed into the ceiling typically to provide bright even lighting. Liteharbor troffers are available in standard 2x2, 2x4 sizes.

HIGH-PERFORMANCE 2X2 RECESSED LED TROFFER

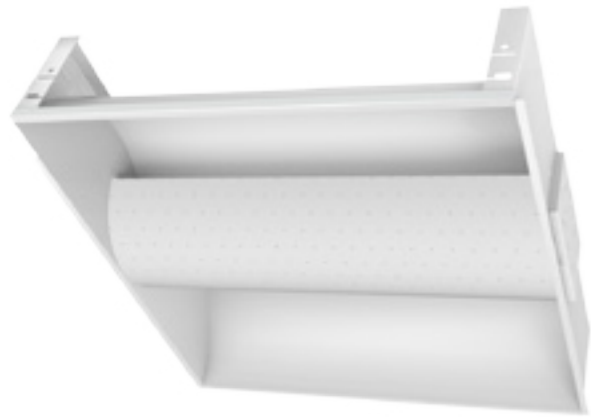

DESCRIPTION

The 2x2 Architectural Basket Series delivers up to 3200 lumens while achieving 100 lumens per watt. Direct/Indirect distribution of soft light creates superior brightness control and balanced light for today's commercial buildings. Available in wide range of color temperatures with 0-10V dimming. No harmful ultraviolet or infrared wavelengths. Contains no lead or mercury.

HOUSING

Cold rolled steel or electro galvanized substrate. Highly reflective white finish on phosphate-free, multi-staged pretreated metal. Air Return has slots above basket. Air Handling has slots along the sides.

BASKET STYLE

2 basket-style optics are available in Opal Diffuser or White Perforated; fixtures provide indirect, efficient lighting for wide-ranging commercial applications.

LED LIGHT ENGINE

Light engine/reflector system produces 2200 to 3200 lumens while using only 32 watts of energy. 3500K, 4000K and 5000K color temperatures. CRI 80/90+. Easily replaceable array boards allow for easy maintenance or updating technology.



DIMENSIONS

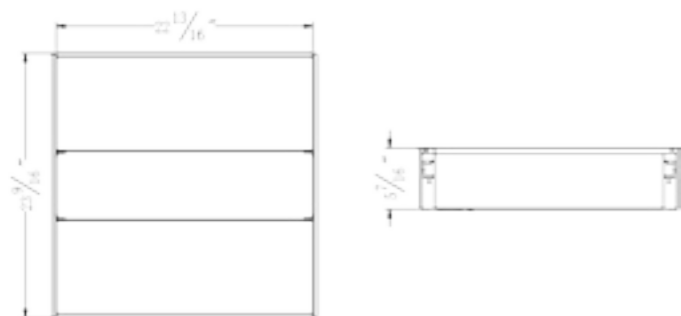

L:22 13/16" W:23 9/16" H: 1 1/8"

ORDERING GUIDE / YOUR PRODUCT CODE

SERIES	INPUT VOLTAGE	DIMMABLE	BASKET STYLE	WATTAGE / LUMEN OUTPUT	CCT
<input type="radio"/> DGL-RF220 2x2 Recessed LED Troffer	<input type="radio"/> 120V <input type="radio"/> 277V <input type="radio"/> 120-277V	<input type="radio"/> Non-Dimmable <input type="radio"/> Dimmable	<input type="radio"/> White Perforated <input type="radio"/> Opal Diffuser	<input type="radio"/> 32W / 3200 Lumen	<input type="radio"/> 3500K <input type="radio"/> 4000K <input type="radio"/> 5000K

* Customized Also Available

LISTING / WARRANTY

ETL listed to US and Canadian standards for damp location W/Feed through. 5 Years Limited Warranty.



Liteharbor Harbor of Light!

HIGH-PERFORMANCE 2X4 RECESSED LED TROFFER



DESCRIPTION

The 2x4 Architectural Basket Series delivers up to 6400 lumens while achieving 100 lumens per watt. Direct/Indirect distribution of soft light creates superior brightness control and balanced light for today's commercial buildings. Available in wide range of color temperatures with 0-10V dimming. No harmful ultraviolet or infrared wavelengths. Contains no lead or mercury.

HOUSING

Cold rolled steel or electro galvanized substrate. Highly reflective white finish on phosphate-free, multi-staged pretreated metal. Air Return has slots above basket. Air Handling has slots along the sides.

BASKET STYLE

2 basket-style optics are available in Opal Diffuser or White Perforated; fixtures provide indirect, efficient lighting for wide-ranging commercial applications.

LED LIGHT ENGINE

Light engine/reflector system produces 4400 to 6400 lumens while using only 64 watts of energy. 3500K, 4000K and 5000K color temperatures. CRI 80/90+. Easily replaceable array boards allow for easy maintenance or updating technology.



DIMENSIONS

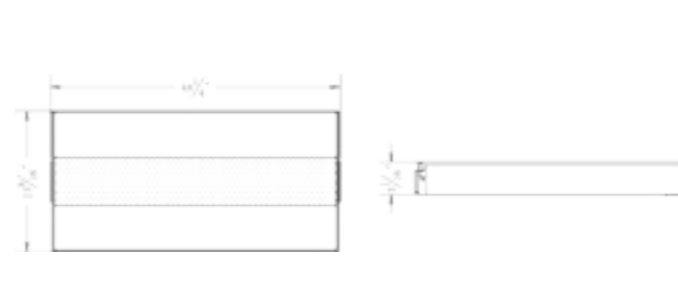

ORDERING GUIDE / YOUR PRODUCT CODE

SERIES	INPUT VOLTAGE	DIMMABLE	BASKET STYLE	WATTAGE / LUMEN OUTPUT	CCT
<input type="radio"/> DGL-RF240 2x4 Recessed LED Troffer	<input type="radio"/> 120V <input type="radio"/> 277V <input type="radio"/> 120-277V	<input type="radio"/> Non-Dimmable <input type="radio"/> Dimmable	<input type="radio"/> White Perforated <input type="radio"/> Opal Diffuser	<input type="radio"/> 64W / 6400 Lumen	<input type="radio"/> 3500K <input type="radio"/> 4000K <input type="radio"/> 5000K

* Customized Also Available

LISTING / WARRANTY

ETL listed to US and Canadian standards for damp location W/Feed through. 5 Years Limited Warranty.

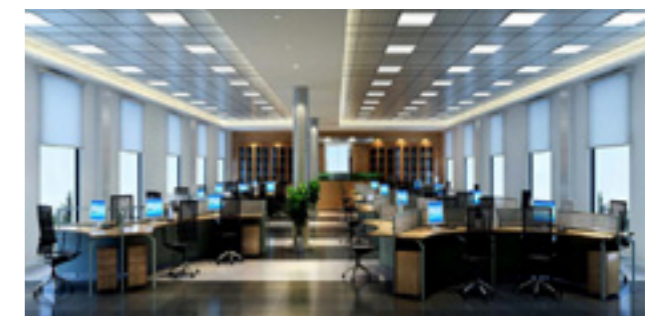

E-mail: info@liteharbor.com

2X2 RECESSED LED TROFFER WITH LIGHT GUIDE PLATE

LIGHT SOURCE SMD CHIPS **DGL-RFD-220**



DESCRIPTION

The RFD-220 is a luminaire which is ideal for commercial applications. Precision formed optical assembly with positively retained high optical grade acrylic lens provides a directed optical distribution using the LED technology. The transmittance of the light guide plate is up to 90%. Even light transmission, no flicker, no granular feeling, no light leakage. Beam Angle: 120°.

LIGHT SOURCE

Using the energy-saving highlighting 5630 SMD LED light source. LED color temperature is available in 2700-6500K. Standard dimming control: 0 ~ 10 v dimming.

Emergency Battery Pack Option

Optional 120v-277v integral emergency battery pack is available in 7-watts or 14-watts to meet critical life-safety lighting requirements. The 90-minute batteries provide constant power to the LED system, ensuring code compliance.

DRIVER

Using isolation constant-current driver power, is the guarantee of security, stability and no flicking.

APPLICATIONS

Suitable for commercial office spaces, schools, hospitals, retail and other indoor ambient applications.



DIMENSIONS

L: 22 13/16"
W: 23 9/16"
H: 5 7/16"

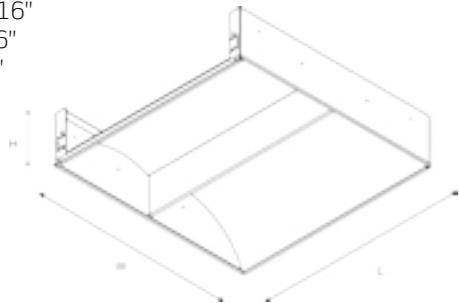

LIGHT DISTRIBUTION CURVE

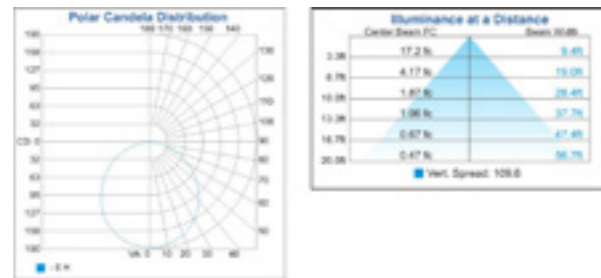

ORDERING GUIDE / YOUR PRODUCT CODE

SERIES	VOLTAGE	WATTAGE/LUMEN	CRI	FINISH	CCT	DIMMING	/	CUSTOMIZED FUNCTIONS
<input type="radio"/> DGL-RFD-220 2x2 Recessed LED Troffer	<input type="radio"/> 120V AC <input type="radio"/> 277V AC <input type="radio"/> 120-277V AC	<input type="radio"/> 24W/1800lm	<input type="radio"/> 80+ <input type="radio"/> 90+	<input type="radio"/> White <input type="radio"/> Silver <input type="radio"/> Black	<input type="radio"/> 2700K <input type="radio"/> 3000K <input type="radio"/> 3500K <input type="radio"/> 4000K <input type="radio"/> 5000K <input type="radio"/> 6000K <input type="radio"/> 6500K	<input type="radio"/> NONE <input type="radio"/> 0-10V Dimming <input type="radio"/> TRIAC Dimming	/	<input type="radio"/> Emergency Backup <input type="radio"/> RGBW <input type="radio"/> Tunable(3000K,4000K,5000K,choose any 2 of them) <input type="radio"/> motion sensor

* Customized Also Available

LISTING / WARRANTY

ETL listed to US and Canadian standards for damp location W/Feed through. 5 Years Limited Warranty.



Liteharbor Harbor of Light!

2X4 RECESSED LED TROFFER WITH LIGHT GUIDE PLATE

LIGHT SOURCE SMD CHIPS **DGL-RFD-240**



DESCRIPTION

The RFD-240 is a luminaire which is ideal for commercial applications. Precision formed optical assembly with positively retained high optical grade acrylic lens provides a directed optical distribution using the LED technology. The transmittance of the light guide plate is up to 90%. Even light transmission, no flicker, no granular feeling, no light leakage. Beam Angle: 120°.

LIGHT SOURCE

Using the energy-saving highlighting 5630 SMD LED light source. LED color temperature is available in 2700-6500K. Standard dimming control: 0 ~ 10 v dimming.

Emergency Battery Pack Option

Optional 120v-277v integral emergency battery pack is available in 7-watts or 14-watts to meet critical life-safety lighting requirements. The 90-minute batteries provide constant power to the LED system, ensuring code compliance.

DRIVER

Using isolation constant-current driver power, is the guarantee of security, stability and no flicking.

APPLICATIONS

Suitable for commercial office spaces, schools, hospitals, retail and other indoor ambient applications.



DIMENSIONS

L: 48 1/4"
W: 23 9/16"
H: 5 7/16"

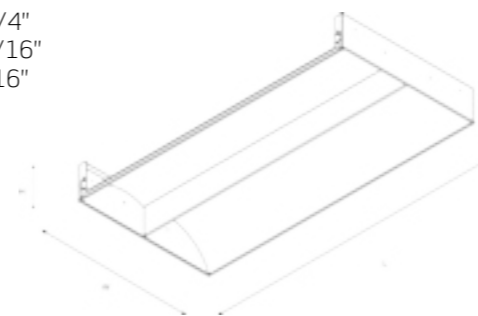

LIGHT DISTRIBUTION CURVE

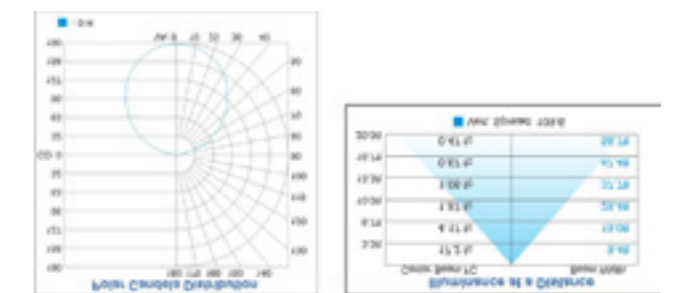

ORDERING GUIDE / YOUR PRODUCT CODE

SERIES	VOLTAGE	WATTAGE/LUMEN	CRI	FINISH	CCT	DIMMING	/	CUSTOMIZED FUNCTIONS
<input type="radio"/> DGL-RFD-240 2x4 Recessed LED Troffer	<input type="radio"/> 120V AC <input type="radio"/> 277V AC <input type="radio"/> 120-277V AC	<input type="radio"/> 48W/3800lm	<input type="radio"/> 80+ <input type="radio"/> 90+	<input type="radio"/> White <input type="radio"/> Silver <input type="radio"/> Black	<input type="radio"/> 2700K <input type="radio"/> 3000K <input type="radio"/> 3500K <input type="radio"/> 4000K <input type="radio"/> 5000K <input type="radio"/> 6000K <input type="radio"/> 6500K	<input type="radio"/> NONE <input type="radio"/> 0-10V Dimming <input type="radio"/> TRIAC Dimming	/	<input type="radio"/> Emergency Backup <input type="radio"/> RGBW <input type="radio"/> Tunable(3000K,4000K,5000K,choose any 2 of them) <input type="radio"/> motion sensor

* Customized Also Available

LISTING / WARRANTY

ETL listed to US and Canadian standards for damp location W/Feed through. 5 Years Limited Warranty.



E-mail:info@liteharbor.com



300x600mm(1x2ft)
600x600mm(2x2ft)
300x1200mm(1x4ft)
600x1200mm(2x4ft)

LOW PROFILE LED PANEL LIGHT

Liteharbor LED Panel Lights offer even light distribution and add a great look to any commercial or residential space. For better, non-glare lighting, replace traditional fixtures with flush fitting LED panels. LED lighting is included with fixture, offering up to 50,000 hours of LED life.

300X600MM(1X2FT) LED PANEL LIGHT

LIGHT SOURCE SMD CHIPS **DGL-P6328**



DESCRIPTION

LED panel light is a kind of top grade indoor lighting product which is composed of a number of high-brightness LEDs. Its unique structure design, side view emitting, uniform plane emitting effect which is formed after the light go through the high-transmittance LGP and diffusion plate, good illumination uniformity and soft light which is comfortable but bright, can relief eye fatigue effectively, and prevent radiation. It will not stimulate the skin of pregnant women, elders and children. The lamp design is simple, beautiful and luxurious. It not only has good lighting effects, but also brings a feeling of beauty. It is a new, top grade and fashionable indoor lighting luminaire.

FEATURES

Leading LED driver design, overlong lifespan.
Newest LGP technology, higher luminous efficiency
Side emitting technology diffuse reflection, uniform and soft light, no glare, no humming, no flare, no direct attention, effectively alleviate eye fatigue, more healthy use.
Delicate structure design, ultra thin and ultra light.
Simple, fashionable and elegant appearance.
Easy installation, can replace the same size of ceiling lights or grille lights.
No lead, no mercury, energy saving and environment friendly.

APPLICATION

LED panel light is widely used in commercial lighting, residential lighting and communal facilities lighting such as meeting room, office, office building and so on.

OPTICS

Input: AC100-277V, 50/60Hz
Suitable for damp locations
Anti-Power Level: Class II
LED Chips: SMD2835/SMD216/SMD4014
LED Q'ty: 60 PCS
Emitting Color: Warm white/Pure white/Cool white
Certifications: UL DLC CE RoHS FCC
50000 Hours Lifetime.
5-Year Limited Warranty.

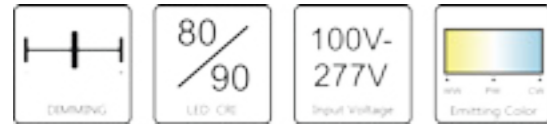

DIMENSIONS



ORDERING GUIDE / YOUR PRODUCT CODE

SERIES	LED CHIPS	WATTAGE/LUMEN	EMITTING COLOR	DIMMABLE
<input type="radio"/> DGL-P6328	<input type="radio"/> SMD2835	<input type="radio"/> 19W / 1600LM	<input type="radio"/> Warm white	<input type="radio"/> NON-Dimmable
<input type="radio"/> 300x600mm(1x2ft)	<input type="radio"/> SMD2016	<input type="radio"/> 20W / 1700LM	<input type="radio"/> Pure white	<input type="radio"/> Dimmable
<input type="radio"/> LED Panel Light	<input type="radio"/> SMD4014	<input type="radio"/> 21W / 1800LM	<input type="radio"/> Cool white	

* Customized Also Available

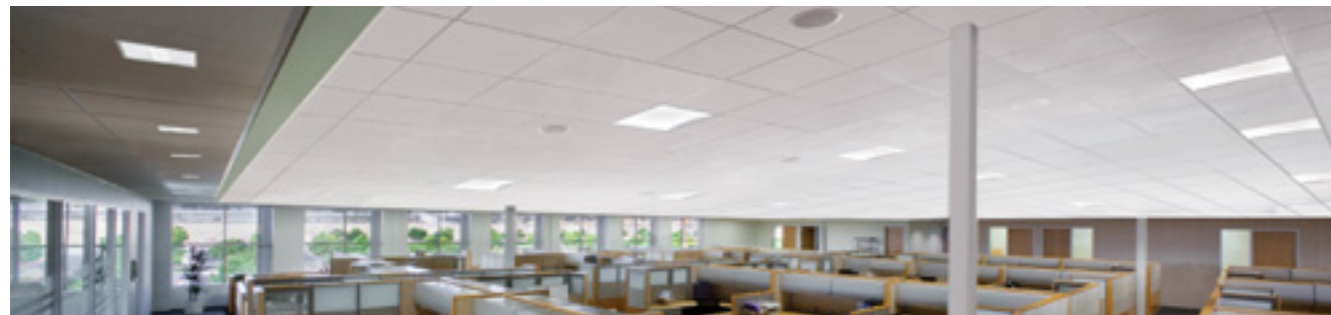

600X600MM(2X2FT) LED PANEL LIGHT

LIGHT SOURCE SMD CHIPS **DGL-P6628**



DESCRIPTION

LED panel light is a kind of top grade indoor lighting product which is composed of a number of high-brightness LEDs. Its unique structure design, side view emitting, uniform plane emitting effect which is formed after the light go through the high-transmittance LGP and diffusion plate, good illumination uniformity and soft light which is comfortable but bright, can relief eye fatigue effectively, and prevent radiation. It will not stimulate the skin of pregnant women, elders and children. The lamp design is simple, beautiful and luxurious, not only has good lighting effects, but also bring a feeling of beauty. It is a new, top grade and fashionable indoor lighting luminaire.

FEATURES

Leading LED driver design, overlong lifespan.
Newest LGP technology, higher luminous efficiency
Side emitting technology diffuse reflection, uniform and soft light, no glare, no humming, no flare, no direct attention, effectively alleviate eye fatigue, more healthy use.
Delicate structure design, ultra thin and ultra light.
Simple, fashionable and elegant appearance.
Easy installation, can replace the same size of ceiling lights or grille lights.
No lead, no mercury, energy saving and environment friendly.

APPLICATION

LED panel light is widely used in commercial lighting, residential lighting and communal facilities lighting such as meeting room, office, office building and so on.

OPTICS

Input: AC100-277V, 50/60Hz
Suitable for damp locations
Anti-Power Level: Class II
LED Chips: SMD2835/SMD216/SMD4014
LED Q'ty: 120 PCS
Emitting Color: Warm white/Pure white/Cool white
Certifications: UL DLC CE RoHS FCC
50000 Hours Lifetime.
5-Year Limited Warranty.

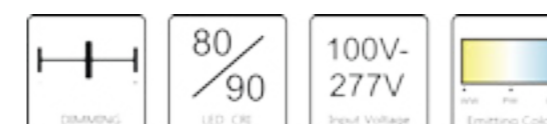

DIMENSIONS



ORDERING GUIDE / YOUR PRODUCT CODE

SERIES	LED CHIPS	WATTAGE/LUMEN	EMITTING COLOR	DIMMABLE
<input type="radio"/> DGL-P6628	<input type="radio"/> SMD2835	<input type="radio"/> 39W / 3200LM	<input type="radio"/> Warm white	<input type="radio"/> NON-Dimmable
<input type="radio"/> 600x600mm(2x2ft)	<input type="radio"/> SMD2016	<input type="radio"/> 40W / 3400LM	<input type="radio"/> Pure white	<input type="radio"/> Dimmable
<input type="radio"/> LED Panel Light	<input type="radio"/> SMD4014	<input type="radio"/> 42W / 3600LM	<input type="radio"/> Cool white	



300X1200MM(1X4FT) LED PANEL LIGHT

LIGHT SOURCE SMD CHIPS **DGL-P12328**



DESCRIPTION

LED panel light is a kind of top grade indoor lighting product which is composed of a number of high-brightness LEDs. Its unique structure design, side view emitting, uniform plane emitting effect which is formed after the light go through the high-transmittance LGP and diffusion plate, good illumination uniformity and soft light which is comfortable but bright, can relief eye fatigue effectively, and prevent radiation. It will not stimulate the skin of pregnant women, elders and children. The lamp design is simple, beautiful and luxurious, not only has good lighting effects, but also bring a feeling of beauty. It is a new, top grade and fashionable indoor lighting luminaire.

FEATURES

Leading LED driver design, overlong lifespan.
Newest LGP technology, higher luminous efficiency
Side emitting technology diffuse reflection, uniform and soft light, no glare, no humming, no flare, no direct attention, effectively alleviate eye fatigue, more healthy use.
Delicate structure design, ultra thin and ultra light.
Simple, fashionable and elegant appearance.
Easy installation, can replace the same size of ceiling lights or grille lights.
No lead, no mercury, energy saving and environment friendly.

APPLICATION

LED panel light is widely used in commercial lighting, residential lighting and communal facilities lighting such as meeting room, office, office building and so on.

OPTICS

Input: AC100-277V, 50/60Hz
Suitable for damp locations
Anti-Power Level: Class II
LED Chips: SMD2835/SMD216/SMD4014
LED Q'ty: 120 PCS
Emitting Color: Warm white/Pure white/Cool white
Certifications: UL DLC CE RoHS FCC
50000 Hours Lifetime.
5-Year Limited Warranty.

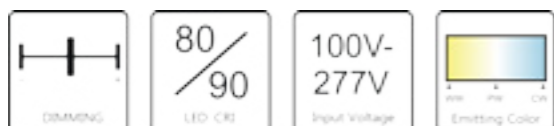

DIMENSIONS



ORDERING GUIDE / YOUR PRODUCT CODE

SERIES	LED CHIPS	WATTAGE/LUMEN	EMITTING COLOR	DIMMABLE
○ DGL-P12328	○ SMD2835	○ 39W / 3200LM	○ Warm white	○ NON-Dimmable
300x1200mm(1x4ft)	○ SMD2016	○ 40W / 3400LM	○ Pure white	○ Dimmable
LED Panel Light	○ SMD4014	○ 42W / 3600LM	○ Cool white	

* Customized Also Available



600X1200MM(2X4FT) LED PANEL LIGHT

LIGHT SOURCE SMD CHIPS **DGL-P12628**



DESCRIPTION

LED panel light is a kind of top grade indoor lighting product which is composed of a number of high-brightness LEDs. Its unique structure design, side view emitting, uniform plane emitting effect which is formed after the light go through the high-transmittance LGP and diffusion plate, good illumination uniformity and soft light which is comfortable but bright, can relief eye fatigue effectively, and prevent radiation. It will not stimulate the skin of pregnant women, elders and children. The lamp design is simple, beautiful and luxurious, not only has good lighting effects, but also bring a feeling of beauty. It is a new, top grade and fashionable indoor lighting luminaire.

FEATURES

Leading LED driver design, overlong lifespan.
Newest LGP technology, higher luminous efficiency
Side emitting technology diffuse reflection, uniform and soft light, no glare, no humming, no flare, no direct attention, effectively alleviate eye fatigue, more healthy use.
Delicate structure design, ultra thin and ultra light.
Simple, fashionable and elegant appearance.
Easy installation, can replace the same size of ceiling lights or grille lights.
No lead, no mercury, saving energy and protecting environment.

APPLICATION

LED panel light is widely used in commercial lighting, residential lighting and communal facilities lighting such as meeting room, office, office building and so on.

OPTICS

Input: AC100-277V, 50/60Hz
Suitable for damp locations
Anti-Power Level: Class II
LED Chips: SMD2835/SMD216/SMD4014
LED Q'ty: 240 PCS
Emitting Color: Warm white/Pure white/Cool white
Certifications: UL DLC CE RoHS FCC
50000 Hours Lifetime.
5-Year Limited Warranty.

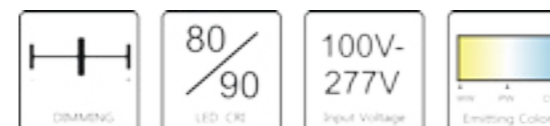

DIMENSIONS



ORDERING GUIDE / YOUR PRODUCT CODE

SERIES	LED CHIPS	WATTAGE/LUMEN	EMITTING COLOR	DIMMABLE
○ DGL-P12628	○ SMD2835	○ 70W / 5700LM	○ Warm white	○ NON-Dimmable
600x1200mm(2x4ft)	○ SMD2016	○ 72W / 6000LM	○ Pure white	○ Dimmable
LED Panel Light	○ SMD4014	○ 75W / 6500LM	○ Cool white	





LED VANITY LIGHT

ELEGANT DESIGNED LED VANITY LIGHT

Liteharbor Vanity Light is an elegant design of bathroom mirror. When you want to use the mirror to apply makeup or check on blemishes, then you need to the mirror where it receives good light. The vanity light can solve this problem by giving you LED lighting.

ELEGANT DESIGNED 2FT LED VANITY LIGHT



DGL-LV-A26

Beam Angle:
180°



Using imported high transmittance PC cover, retain color for long time. ↑

Power: 20W

Voltage: 120V/277V
120V ~ 277V AC

Frequency: 50/60Hz

Power factor: >0.98

CRI: 80+/90+

Dimmable: NONE/0-10V/TRIAC

CCT: 2700-6500K

Suitable for damp locations

FEATURES

DGL-LV-A26 is a high lumen, thin, beautiful appearance, safe and reliable, convenient installation and easy maintenance led vanity light. Customized residential and commercial lighting applications with this LED cylinder vanity light. The contemporary cylinder is constructed of an acrylic diffuser with housing available in either a brushed nickel or chrome finish. The included canopy/junction box cover is removable for a more low profile look (2'-4' lengths only). The white acrylic diffuser provides even illumination and softens the appearance of the LEDs for improved aesthetics. Standard finish is powder coat textured white. Optional silver, black or custom color paint finishes.

CONSTRUCTION

Using imported high transmittance PC cover, retain color for long time. Available in 1x2, 1x3 and 1x4 models

LIGHT SOURCE

Using the energy-saving highlighting 2835 SMD LED light source. Distributed LED array in a variety of lumen output packages. LED color is available in 2700-6500K. Module is replaceable.

DRIVER

Using isolation constant-current driver power, is the guarantee of security, stability and no flicking.

MOUNTING

Wall mounted.

LISTING / WARRANTY

ETL listed, conforms to UL Standard 1598 / 8750 and CSA Standard C22.2, Damp location. 5-year limited warranty on LED and Driver.



DIMENSIONS

W: 4 7/8"
H: 3 5/6"



PACKING

CTN Size: 630x420x155mm (4 PCS/CTN)
Inner Box Size: 615x130x100mm

MOUNTING

Wall mounted.

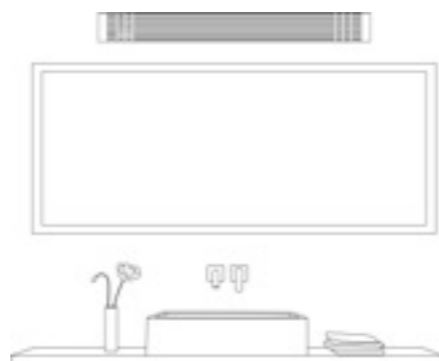

ORDERING GUIDE / YOUR PRODUCT CODE

SERIES	VOLTAGE	WATTAGE/LUMEN	MOUNTING	FINISH	CCT	DIMMING	CUSTOMIZED FUNCTIONS	
ODGL-LV-A26 2 FT LED Vanity Light	<input type="radio"/> 120V AC	<input type="radio"/> 20W/1600LM	<input type="radio"/> Wall Mounted	<input type="radio"/> White	<input type="radio"/> 2700K	<input type="radio"/> NONE	<input type="radio"/> Emergency Backup	
	<input type="radio"/> 277V AC			<input type="radio"/> Silver	<input type="radio"/> 3000K	<input type="radio"/> 0-10V Dimming	<input type="radio"/> RGBW	
	<input type="radio"/> 120-277V AC			<input type="radio"/> Black	<input type="radio"/> 3500K	<input type="radio"/> TRIAC Dimming	<input type="radio"/> Tunable(3000K,4000K, 5000K,choose any 2 of them)	<input type="radio"/> motion sensor
				<input type="radio"/> 4000K				
				<input type="radio"/> 5000K				
				<input type="radio"/> 6000K				
	<input type="radio"/> 6500K							

* Customized Also Available

ELEGANT DESIGNED 2FT LED VANITY LIGHT



DGL-LV-B26

Beam Angle:
180°



Using imported high transmittance PC cover, retain color for long time. ↑

Power: 20W

Voltage: 120V/277V
120V ~ 277V AC

Frequency: 50/60Hz

Power factor: >0.98

CRI: 80+/90+

Dimmable: NONE/0-10V/TRIAC

CCT: 2700-6500K

Suitable for damp locations

FEATURES

DGL-LV-B26 is a high lumen, thin, beautiful appearance, safe and reliable, convenient installation and easy maintenance led vanity light. Customized residential and commercial lighting applications with this LED cylinder vanity light. The contemporary cylinder is constructed of an acrylic diffuser with housing available in either a brushed nickel or chrome finish. The included canopy/junction box cover is removable for a more low profile look (2'-4' lengths only). The white acrylic diffuser provides even illumination and softens the appearance of the LEDs for improved aesthetics. Standard finish is powder coat textured white. Optional silver, black or custom color paint finishes.

CONSTRUCTION

Using imported high transmittance PC cover, retain color for long time. Available in 1x2, 1x3 and 1x4 models

LIGHT SOURCE

Using the energy-saving highlighting 2835 SMD LED light source. Distributed LED array in a variety of lumen output packages. LED color is available in 2700-6500K. Module is replaceable.

DRIVER

Using isolation constant-current driver power, is the guarantee of security, stability and no flicking.

MOUNTING

Wall mounted.

LISTING / WARRANTY

ETL listed, conforms to UL Standard 1598 / 8750 and CSA Standard C22.2, Damp location. 5-year limited warranty on LED and Driver.



DIMENSIONS

W: 4 7/8"
H: 3 5/6"

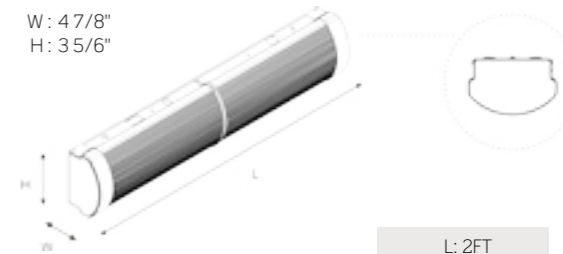

PACKING

CTN Size: 630x420x155mm (4 PCS/CTN)
Inner Box Size: 615x130x100mm

MOUNTING

Wall mounted.

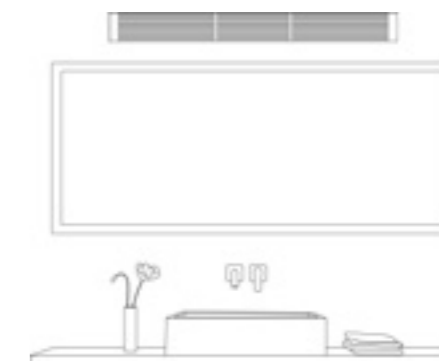

ORDERING GUIDE / YOUR PRODUCT CODE

SERIES	VOLTAGE	WATTAGE/LUMEN	MOUNTING	FINISH	CCT	DIMMING	CUSTOMIZED FUNCTIONS	
DGL-LV-B26 2 FT LED Vanity Light	<input type="radio"/> 120V AC	<input type="radio"/> 20W/1600LM	<input type="radio"/> Wall Mounted	<input type="radio"/> White	<input type="radio"/> 2700K	<input type="radio"/> NONE	<input type="radio"/> Emergency Backup	
	<input type="radio"/> 277V AC			<input type="radio"/> Silver	<input type="radio"/> 3000K	<input type="radio"/> 0-10V Dimming	<input type="radio"/> RGBW	
	<input type="radio"/> 120-277V AC			<input type="radio"/> Black	<input type="radio"/> 3500K	<input type="radio"/> TRIAC Dimming	<input type="radio"/> Tunable(3000K,4000K, 5000K,choose any 2 of them)	<input type="radio"/> motion sensor
				<input type="radio"/> 4000K				
				<input type="radio"/> 5000K				
				<input type="radio"/> 6000K				
	<input type="radio"/> 6500K							

* Customized Also Available

ELEGANT DESIGNED 3FT LED VANITY LIGHT

LIGHT SOURCE SMD CHIPS **DGL-LV-A36**

Beam Angle:
180°



Using imported high transmittance PC cover, retain color for long time. ↑

Power: 30W
Voltage: 120V/277V 120V ~ 277V AC
Frequency: 50/60Hz
Power factor: >0.98
CRI: 80+/90+
Dimmable: NONE/0-10V/TRIAC
CCT: 2700-6500K
Suitable for damp locations

FEATURES

DGL-LV-A36 is a high lumen, thin, beautiful appearance, safe and reliable, convenient installation and easy maintenance led vanity light. Customized residential and commercial lighting applications with this LED cylinder vanity light. The contemporary cylinder is constructed of an acrylic diffuser with housing available in either a brushed nickel or chrome finish. The included canopy/junction box cover is removable for a more low profile look (2'-4' lengths only). The white acrylic diffuser provides even illumination and softens the appearance of the LEDs for improved aesthetics. Standard finish is powder coat textured white. Optional silver, black or custom color paint finishes.

CONSTRUCTION

Using imported high transmittance PC cover, retain color for long time. Available in 1x2, 1x3 and 1x4 models

LIGHT SOURCE

Using the energy-saving highlighting 2835 SMD LED light source. Distributed LED array in a variety of lumen output packages. LED color is available in 2700-6500K. Module is replaceable.

DRIVER

Using isolation constant-current driver power, is the guarantee of security, stability and no flicking.

MOUNTING

Wall mounted.

LISTING / WARRANTY

ETL listed, conforms to UL Standard 1598 / 8750 and CSA Standard C22.2, Damp location. 5-year limited warranty on LED and Driver.



DIMENSIONS

W: 4 7/8"
H: 3 5/6"



L: 3FT

PACKING

CTN Size: 935x420x155mm (4 PCS/CTN)
Inner Box Size: 920x130x100mm

MOUNTING

Wall mounted.



ORDERING GUIDE / YOUR PRODUCT CODE

SERIES	VOLTAGE	WATTAGE/LUMEN	MOUNTING	FINISH	CCT	DIMMING	CUSTOMIZED FUNCTIONS
DGL-LV-A36 3 FT LED Vanity Light	120V AC	30W/2500LM	Wall Mounted	White	2700K	NONE	Emergency Backup
	277V AC			Silver	3000K	0-10V Dimming	RGBW
	120-277V AC			Black	3500K	TRIAC Dimming	Tunable(3000K,4000K, 5000K,choose any 2 of them)
					4000K		motion sensor
					5000K		
					6000K		
			6500K				

* Customized Also Available

ELEGANT DESIGNED 3FT LED VANITY LIGHT

LIGHT SOURCE SMD CHIPS **DGL-LV-B36**

Beam Angle:
180°



Using imported high transmittance PC cover, retain color for long time. ↑

Power: 30W
Voltage: 120V/277V 120V ~ 277V AC
Frequency: 50/60Hz
Power factor: >0.98
CRI: 80+/90+
Dimmable: NONE/0-10V/TRIAC
CCT: 2700-6500K
Suitable for damp locations

FEATURES

DGL-LV-B36 is a high lumen, thin, beautiful appearance, safe and reliable, convenient installation and easy maintenance led vanity light. Customized residential and commercial lighting applications with this LED cylinder vanity light. The contemporary cylinder is constructed of an acrylic diffuser with housing available in either a brushed nickel or chrome finish. The included canopy/junction box cover is removable for a more low profile look (2'-4' lengths only). The white acrylic diffuser provides even illumination and softens the appearance of the LEDs for improved aesthetics. Standard finish is powder coat textured white. Optional silver, black or custom color paint finishes.

CONSTRUCTION

Using imported high transmittance PC cover, retain color for long time. Available in 1x2, 1x3 and 1x4 models

LIGHT SOURCE

Using the energy-saving highlighting 2835 SMD LED light source. Distributed LED array in a variety of lumen output packages. LED color is available in 2700-6500K. Module is replaceable.

DRIVER

Using isolation constant-current driver power, is the guarantee of security, stability and no flicking.

MOUNTING

Wall mounted.

LISTING / WARRANTY

ETL listed, conforms to UL Standard 1598 / 8750 and CSA Standard C22.2, Damp location. 5-year limited warranty on LED and Driver.



DIMENSIONS

W: 4 7/8"
H: 3 5/6"



L: 3FT

PACKING

CTN Size: 935x420x155mm (4 PCS/CTN)
Inner Box Size: 920x130x100mm

MOUNTING

Wall mounted.



ORDERING GUIDE / YOUR PRODUCT CODE

SERIES	VOLTAGE	WATTAGE/LUMEN	MOUNTING	FINISH	CCT	DIMMING	CUSTOMIZED FUNCTIONS
DGL-LV-B36 3 FT LED Vanity Light	120V AC	30W/2500LM	Wall Mounted	White	2700K	NONE	Emergency Backup
	277V AC			Silver	3000K	0-10V Dimming	RGBW
	120-277V AC			Black	3500K	TRIAC Dimming	Tunable(3000K,4000K, 5000K,choose any 2 of them)
					4000K		motion sensor
					5000K		
					6000K		
			6500K				

* Customized Also Available

ELEGANT DESIGNED 4FT LED VANITY LIGHT



Beam Angle:
180°



Using imported high transmittance PC cover, retain color for long time. ↑

Power: 40W
Voltage: 120V/277V 120V ~ 277V AC
Frequency: 50/60Hz
Power factor: >0.98
CRI: 80+/90+
Dimmable: NONE/0-10V/TRIAC
CCT: 2700-6500K
Suitable for damp locations

FEATURES

DGL-LV-A46 is a high lumen, thin, beautiful appearance, safe and reliable, convenient installation and easy maintenance led vanity light. Customized residential and commercial lighting applications with this LED cylinder vanity light. The contemporary cylinder is constructed of an acrylic diffuser with housing available in either a brushed nickel or chrome finish. The included canopy/junction box cover is removable for a more low profile look (2'-4' lengths only) The white acrylic diffuser provides even illumination and softens the appearance of the LEDs for improved aesthetics. Standard finish is powder coat textured white. Optional silver, black or custom color paint finishes.

CONSTRUCTION

Using imported high transmittance PC cover, retain color for long time. Available in 1x2, 1x3 and 1x4 models

LIGHT SOURCE

Using the energy-saving highlighting 2835 SMD LED light source. Distributed LED array in a variety of lumen output packages. LED color is available in 2700-6500K. Module is replaceable.

DRIVER

Using isolation constant-current driver power, is the guarantee of security, stability and no flicking.

MOUNTING

Wall mounted.

LISTING / WARRANTY

ETL listed, conforms to UL Standard 1598 / 8750 and CSA Standard C22.2, Damp location. 5-year limited warranty on LED and Driver.



DIMENSIONS

W: 4 7/8"
H: 3 5/6"



PACKING

CTN Size: 1240x420x155mm (4 PCS/CTN)
Inner Box Size: 1225x130x100mm

MOUNTING

Wall mounted.



ORDERING GUIDE / YOUR PRODUCT CODE

SERIES	VOLTAGE	WATTAGE/LUMEN	MOUNTING	FINISH	CCT	DIMMING	CUSTOMIZED FUNCTIONS	
○ DGL-LV-A46 4 FT LED Vanity Light	○ 120V AC	○ 40W/3400LM	○ Wall Mounted	○ White	○ 2700K	○ NONE	○ Emergency Backup	
	○ 277V AC			○ Silver	○ 3000K	○ 0-10V Dimming	○ RGBW	
	○ 120-277V AC			○ Black	○ 3500K	○ TRIAC Dimming	○ Tunable(3000K,4000K,5000K,choose any 2 of them)	○ motion sensor
				○ 4000K				
				○ 5000K				
				○ 6000K				
				○ 6500K				

* Customized Also Available

ELEGANT DESIGNED 4FT LED VANITY LIGHT



Beam Angle:
180°



Using imported high transmittance PC cover, retain color for long time. ↑

Power: 40W
Voltage: 120V/277V 120V ~ 277V AC
Frequency: 50/60Hz
Power factor: >0.98
CRI: 80+/90+
Dimmable: NONE/0-10V/TRIAC
CCT: 2700-6500K
Suitable for damp locations

FEATURES

DGL-LV-B46 is a high lumen, thin, beautiful appearance, safe and reliable, convenient installation and easy maintenance led vanity light. Customized residential and commercial lighting applications with this LED cylinder vanity light. The contemporary cylinder is constructed of an acrylic diffuser with housing available in either a brushed nickel or chrome finish. The included canopy/junction box cover is removable for a more low profile look (2'-4' lengths only) The white acrylic diffuser provides even illumination and softens the appearance of the LEDs for improved aesthetics. Standard finish is powder coat textured white. Optional silver, black or custom color paint finishes.

CONSTRUCTION

Using imported high transmittance PC cover, retain color for long time. Available in 1x2, 1x3 and 1x4 models

LIGHT SOURCE

Using the energy-saving highlighting 2835 SMD LED light source. Distributed LED array in a variety of lumen output packages. LED color is available in 2700-6500K. Module is replaceable.

DRIVER

Using isolation constant-current driver power, is the guarantee of security, stability and no flicking.

MOUNTING

Wall mounted.

LISTING / WARRANTY

ETL listed, conforms to UL Standard 1598 / 8750 and CSA Standard C22.2, Damp location. 5-year limited warranty on LED and Driver.



DIMENSIONS

W: 4 7/8"
H: 3 5/6"



PACKING

CTN Size: 1240x420x155mm (4 PCS/CTN)
Inner Box Size: 1225x130x100mm

MOUNTING

Wall mounted.



ORDERING GUIDE / YOUR PRODUCT CODE

SERIES	VOLTAGE	WATTAGE/LUMEN	MOUNTING	FINISH	CCT	DIMMING	CUSTOMIZED FUNCTIONS	
○ DGL-LV-B46 4 FT LED Vanity Light	○ 120V AC	○ 40W/3400LM	○ Wall Mounted	○ White	○ 2700K	○ NONE	○ Emergency Backup	
	○ 277V AC			○ Silver	○ 3000K	○ 0-10V Dimming	○ RGBW	
	○ 120-277V AC			○ Black	○ 3500K	○ TRIAC Dimming	○ Tunable(3000K,4000K,5000K,choose any 2 of them)	○ motion sensor
				○ 4000K				
				○ 5000K				
				○ 6000K				
				○ 6500K				

* Customized Also Available



DOORPLATE LED WALL SCONCE

Liteharbor Doorplate LED Wall Sconce is the perfect complementary name plate featured lighting. It illuminates to give off a great looking back-lit ambiance to the front of a room, mounting to a wall or entryway. Add your own printed graphics to showcase the backlit lighting for a unique appearance!

DOORPLATE LED WALL SCONCE



FEATURE

Good colour rendering , CRI 80+ /90+
 No glare, soft light with 3000K CCT.
 Clear and bright, 92% light transmittance.
 Good alternative for conventional door number plate
 Acrylic doorplate, nontoxic and environmentally friendly.
 Easy installation, mount on standard junction box
 Acrylic board information and thickness can be customized.

SPECIFICATION

Light Source: SMD LED
 Input Voltage : AC100-240V 50/60Hz
 Chip Supplier: Seoul/Cree/Epistar/Osram
 PF>0.9
 Working Environment: -35°- 40°
 Suitable for dry locations
 Working Life Time: 20000Hrs

MATERIAL

Fixture Body: Die cast (Powder coated finished)
 Other Components: Die cast (Powder coated finished)



DIMENSIONS



PACKING

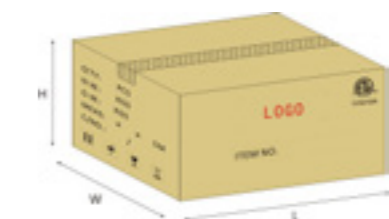

- Inner Box:
 L:260xW:95xH:270mm
 - Outer Carton:
 L:535xW:400xH:295mm
 - 8 PCS/CTN

ORDERING GUIDE / YOUR PRODUCT CODE

SERIES	CCT	LED AVAILABLE	FINISH	FACE SIGN NUMBER
<input type="radio"/> WS-D001 Doorplate LED Wall Sconce	<input type="radio"/> 2700K <input type="radio"/> 3000K <input type="radio"/> 4000K	<input type="radio"/> Cree <input type="radio"/> Epistar <input type="radio"/> Seoul <input type="radio"/> Osram	<input type="radio"/> White <input type="radio"/> Black <input type="radio"/> Satin Nickel	<input type="radio"/> Customize

* Customized Also Available

LISTING / WARRANTY

5 Years Limited Warranty.



