



PROFESSIONAL IN LIGHTING
MANUFACTURING
SINCE 2006



A Liteharbor Lighting Technology Co., Ltd(Factory A)

Liteharbor Lighting Technology Co., Ltd was founded in 2006, Its predecessor is Yalle Lighting, We are a manufacturer with 15-year experiences in designing, developing and supplying wide selections of lighting products.

Liteharbor factory covers an area of 2,6000m2 , There are hardware factory, mold factory, carton factory, assembly plant and LED factory and many other factories, and all those factory are well-equipped.

LiteharborLighting offers 38 product Series, 3000 varieties of products (Mirror Light, Exit& Emergency Light, Recessed Downlight, LED Retrofit Downlight, Multiple Downlight, Ceiling Light, Track Light ,LED Linear Light, and a lot kinds of outdoor lights). All Liteharbor products are strictly conforming to international standards. Liteharborobtained over 200 international and domestic certification(cULus, cETLus, Energy Star, DLC, CE, RoHS). We add 30 new product patents annually. At present, we have acquired the ISO9001 International Quality System Certificate.We have been awarded "national high-tech enterprise", "green lighting enterprise", "enterprise technology center", etc.

www.liteharbor.com

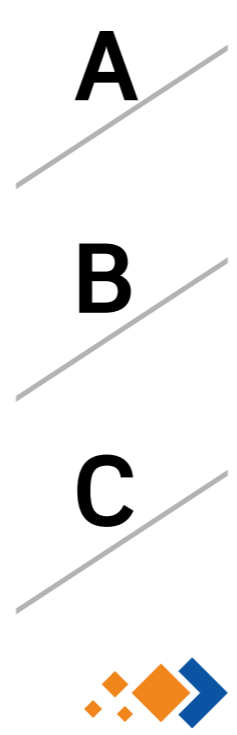

B Liteharbor Lighting marketing & sales headquarter

Liteharbor products are mainly exported to developed countries such as the US and Canada, 14 years accumulated a wealth of products in developed countries and industry experience, and in June 2011, We have established a domestic and Eurasian marketing center to undertake highend lighting projects, lighting projects and lighting solutions.

14 years, we have been committed to providing customers with professional, leading high-quality lighting products and quality, excellent efficient service.

C Liteharbor Lighting college of commerce

Liteharbor Business School is invested in December 25, 2015, Founded by Liteharbor lighting technology co., LTD. In the initial stage, there were 16 internal lecturers. Course contents include the marketing, e-commerce, network operations, business skills, enterprise culture, enterprise management, lighting and photovoltaic and other professional knowledge and experience to share content.

Liteharbor Business School is multifaceted create a learning environment and atmosphere, let more enterprise staff here can rapid growth, so that the business school has become the effective brand incubator company.

The Year of 2006



In May, Yalic Lighting (Nanhai Hardware Products Co., Ltd.) was founded. (Liteharbor's predecessor)

In June, Authorized by cULus cETLus

In August, The plant has been moved, the area expanded to 3500 square meters

Establishment of Sino-US Joint Venture Company

The Year of 2009



In June, Liteharbor Lighting Technology Co., Ltd was founded.

In June, Became a PHILIPS OEM channel business

In June, Became an OSRAM OEM channel business

In September, Establishment of marketing center

In October, win the bidding of the Project of the United States Consulate in Guangzhou.

The Year of 2010



In January, ERP management software was introduced

In February, Newly added 8600 square meter plant

Became a supplier and partner of Thomas & Betts

Establishment of LED Workshop

Establishment of Plant Growth Lamp Workshop

The Year of 2011



In April, LITEHARBOR brand was registered in North America, Hongkong and China

In May, Became director of Foshan Lighting Association

In July, integrated hardware factory, powder coating factory, spinning factory, mold factory

The Year of 2012



In March, Established Hong Kong (Hongkong) International Company

In December, established packaging and printing Factory

The Project of the United States Consulate in Guangzhou completed

Won the lighting project of Chengdu Qingyang Square

The Year of 2013



In May, Passed the ISO9001:2008 international standard quality management system certification

In September, Founded Foshan network business association, Liteharbor became executive chairman of the unit

In September, win the bidding of Beichen lighting project.

In September, Became BRIDGELUX channel business

In November, win the bidding of tide courtyard lighting project

The Year of 2014



In March, established Guangdong Intance Energy Technology Co Ltd

In June, win the bidding of the Qingyang Plaza lighting project

In July, the warehouse and office were rebuilt

In August, recognized as Nanhai green lighting enterprises

The Year of 2015



In April, win the bidding of the U.S. Embassy in Beijing lighting engineering projects

In May, became the world's top 500 well-known brands lighting products and solutions provider

In August, won the lighting project of Li Zhuang

In October, certified 22 cULus/cETLus/CE/CCC/TUV/CQC and obtained 11 patents.

The Year of 2016



The title of "Guangdong high-tech enterprise" was recognized

Identification of "provincial enterprise technology center"

Won the Top 12 of Alibaba New Foreign Trade Competition and won the Best Popularity Award

The Year of 2017



The name of "private technology enterprise in Guangdong province" organized by the Guangdong science and Technology Department

Obtain the title of "quality brand enterprise" issued by ten ministries and commissions

Selected "top 100 enterprises of LED lighting applications in China" selection"

Won the "2017 China lighting industry's ten major commercial lighting brand" title

Selected as "China's top 100 LED lighting applications and Top 100 lighting project" title

The Year of 2018

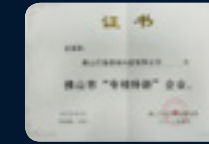

Won "Guangdong LED benchmarking enterprise"

Won the title of "2018 China Top 10 LED lighting brand"

Newly established die-cast branch company

Won the high tech LED Golden Globe award"

Billy was appointed as the 6th General Manager of Liteharbor

Newly established LED lighted Mirror branch company

Awarded "top ten real estate company a-class supplier" honor

Won "professionality, delicacy, specialty, novelty" enterprise of Foshan

The Year of 2019



Establishment of Indonesian factory

Became a supplier and partner of Rexel

Obtain "annual China Top 10 LED lighting application enterprises" title

Establishment of Vietnam factory

In June, Upgrade ISO9001:2008 to ISO9001:2015 International Standard Quality Management System Certification

Establishment of Cambodia factory

The Year of 2020



Future

COMPANY DEVELOPMENT History

Liteharbor Harbor of Light!

CORPORATE CULTURE

Liteharbor declaration:

I love myself, I will always cherish a warm, thanksgiving, kind and tolerant heart. Sincere treatment with my colleagues, rain and wind, and go beyond self! I will rely on my wisdom and efforts, the immediate work to the utmost, and speak with results! In my life, I must do it, no corruption, no waste, no abuse of power! I must do: no manufacturing, no passing and no accepting bad products, I must do: knowing the truth, the real, do practical work, seek practical results; I must: reduce the cost, improve efficiency, obey management, obey the rules, keep the secret! I take Liteharbor as my home, and Liteharbor is proud of me. I am an excellent Liteharbor family member.

Mission:

To provide advanced and scientific lighting technology and light environment

Vision:

Where there is a need of lighting, where there is Liteharbor

Value:

The customer is supreme, action, innovation, unity and progress, integrity



Open office environment



Liteharbor Business School Start Ceremony



"Mo Hai Shu Xiang" Reading Month Start Meeting



Liteharbor Lighting was invited to participate in China (Guangdong) - Canada (Great Britain, Columbia) economic and trade cooperation and exchange meeting

On May 9, 2016, chairman Billy Liang was invited to attend the China (Guangdong) - Canada (British Columbia) (BC) economic and trade cooperation conference, and posed for pictures with all business and political parties. The exchange was held at the Vancouver Convention and Exhibition center. Political, commercial, academic and media circles, more than 500 people attended.



Address by Secretary of the CPC Guangdong Provincial Committee (ChunhuaHu)



Liteharbor Lighting's enterprise representatives participated in the cooperation and communication meeting



Foshan network operators association inaugural meeting - Executive Chairman (Billy Liang) speech

Foshan network business association is a non-profit organization initiated by members. It was established in November 11, 2013. Since its establishment, the chamber of Commerce has 300 member enterprises, more than 60 members of the Council, the total output value of 10 billion yuan. Chamber of commerce is committed to the rapid growth of member enterprises, to promote complementary advantages among members of enterprises, win-win cooperation, and strengthen relations between members, enterprises and government.

As the Foshan municipal network Liteharbor Lighting Association executive president at the beginning of the "unit", chairman Billy Liang served as executive president of association, we witnessed the growth of the association and the association, together to share a total growth!



Big love activities to help poor families

www.liteharbor.com



Liteharbor won the Foshan network operators association "executive chairman unit"



Liteharbor Lighting was invited to participate in the press conference of Foshan e-commerce Expo

2014 Chinese (Foshan) international e-commerce Expo in November 28 - 29 at the Foshan International Conference and Exhibition Center, through the online platform, service providers to demonstrate experience offline mode O2O, enterprise or business owners can make more in-depth understanding of e-commerce, e-commerce for enterprises is not difficult to do. The Expo aims to build an effective communication platform for platform providers, service providers and traditional enterprises. As a leader in the electricity supplier industry, Liteharbor has actively organized and participated in the exposition. Liteharbor has confidence that it can develop further and further on the road of e-commerce in the future



Foshan e-commerce Expo site



Liteharbor Team won the championship at the Alibaba foreign trade horse race"



Visit remote mountain village Hope Primary School

in the development of enterprise at the same time, Liteharbor lighting help charityfor many years, chairman Billy Liang repeatedly visited a remote village hope primary school to bring the team, take up supplies for the children in poor mountainous areas; and in the holiday day, lead the team go to the orphanage to visit the elderly, send them warmth and love; in the Wenchuan earthquake and Ludian earthquake, is donated more than 1 million of the goods, In the future, Liteharborlighting will continue to give charity, stick to it, to help more people who need help.



Accompany the welfare of the elderly for Christmas



Liteharbor Team offer love to the afflicted compatriots in Ludian



Integrating sphere test room

Fully meet the various photochromic performance test and analysis of related test sources, spectral power distribution, measurement of LED chromaticity coordinates, color temperature, color rendering index, color difference, peak wavelength, spectral half width, dominant wavelength, color purity, luminous flux, luminous intensity, luminous efficiency, forward voltage, reverse leakage current etc. light electric performance parameters; fully meet the CIE measurement of light and color requirements.



Color difference test



Salt spray test

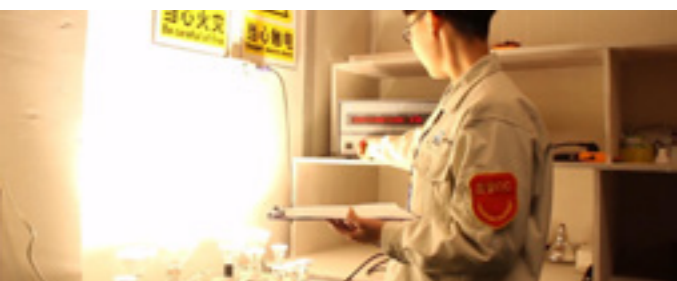

Testing of electrical parameters of products at different voltages



Temperature rise test



Lamps assembly workshop

Hardware Factory | Mold Factory | Carton Factory | Assembly Plant | Led Factory
 Liteharbor lighting assembly workshop set up 6 assembly lines, strictly abide by the ISO9001 quality management measures management operations, mainly assembled lamps, finished products and product packaging, but also set up a finished product inspection workshop. This scale of production provides a solid backing for our capacity assurance, quality control, high efficiency, low consumption and cost control.



Laser Cutting Machine



Numerical Control Press Machine



Horizontal Cold Pressure Chamber Die Casting Machine

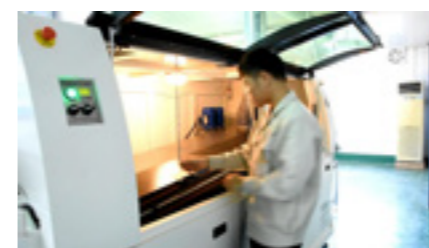

Full-Automatic Energy Saving Wave Soldering Equipment



Laser Marking Machine



Intelligent Monitoring Type Power Aging Test Equipment

GLOBAL STRATEGIC PARTNER FOR LITEHARBOR LIGHTING

www.liteharbor.com

CREATING GREEN FOR ENVIRONMENT
AND CREATING
VALUE FOR CUSTOMERS



OSRAM



PHILIPS



3M Science



LEDIA Lighting



CIMC



LITEHARBOR



LESSO



SYLVANIA



THORN



MEAN WELL



OPPLE



IDEAL



NVC

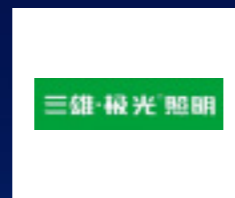

PAK



HUAYI LIGHTING



KINGSUN



TCL



LUMILEDS



CREE



EPISTAR

PROJECT LIGHTING SOLUTION

Liteharbor Harbor of Light!

THE QUALIFICATION Of The Enterprise

Over the past 12 years, Liteharbor has made gratifying achievements, both of which are the crystallization of the wisdom and actions of the people of Liteharbor, all of which are designed to enable customers to enjoy better and more advanced products and services.

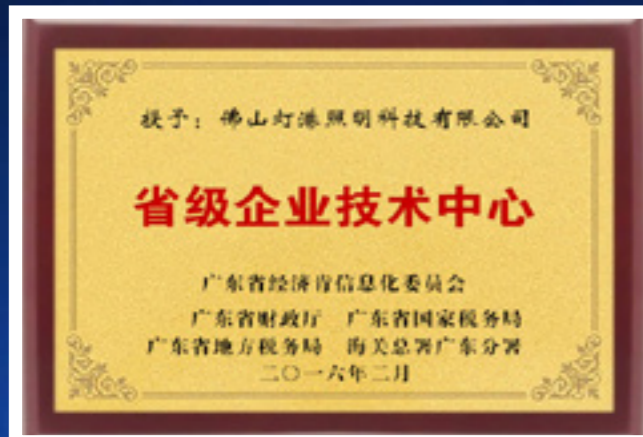
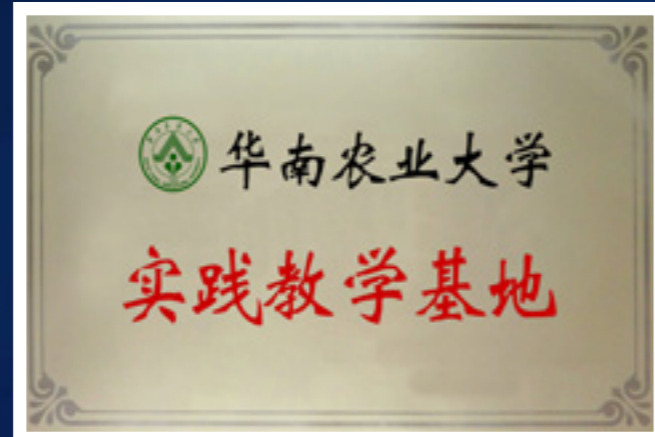



26

ROTATABLE LED EYEBALL DOWNLIGHT



60

MINIATURE LED RECESSED DOWNLIGHT



74

LED DOWNLIGHT SERIES

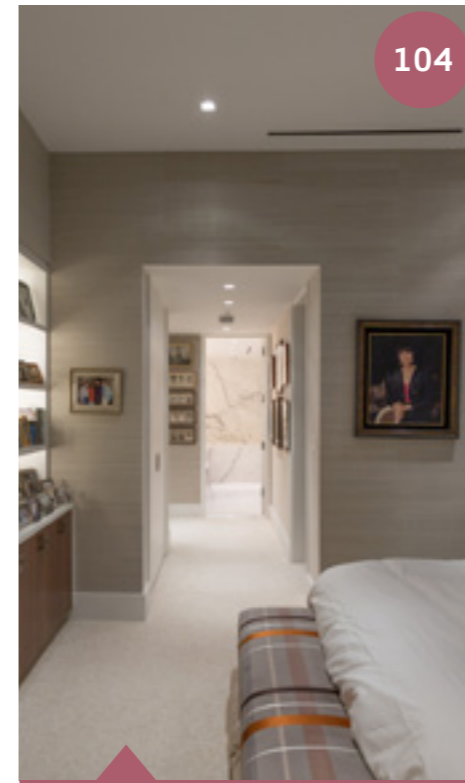

104

ARTISTIC DESIGN LED RETROFIT TRIM

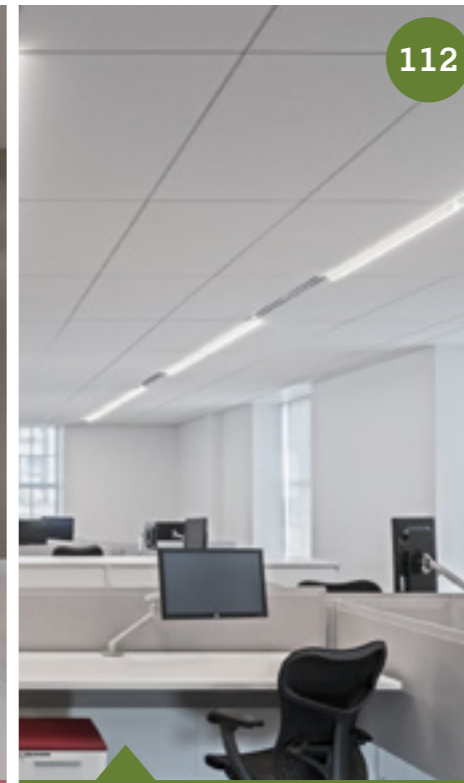

112

LED LINEAR/WRAP LIGHT



135

T8 LINEAR LIGHT SERIES

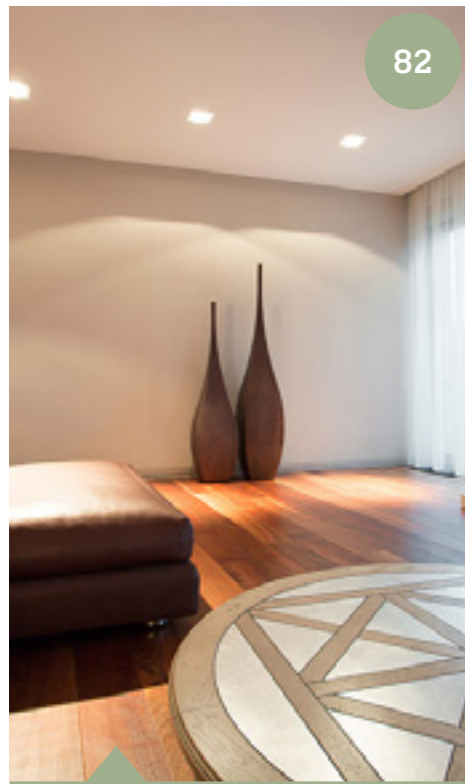

82

LED RECESSED PANEL LIGHT



94

GIMBAL LED RECESSED PANEL LIGHT

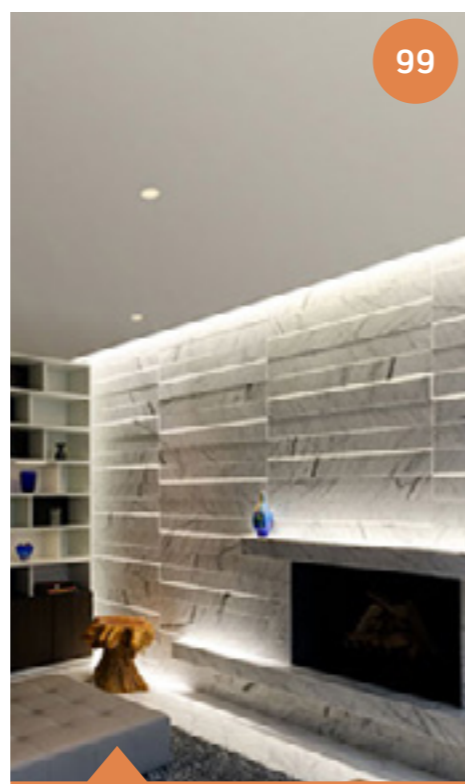

99

SLEEK DESIGN LED DOME LIGHT SERIES

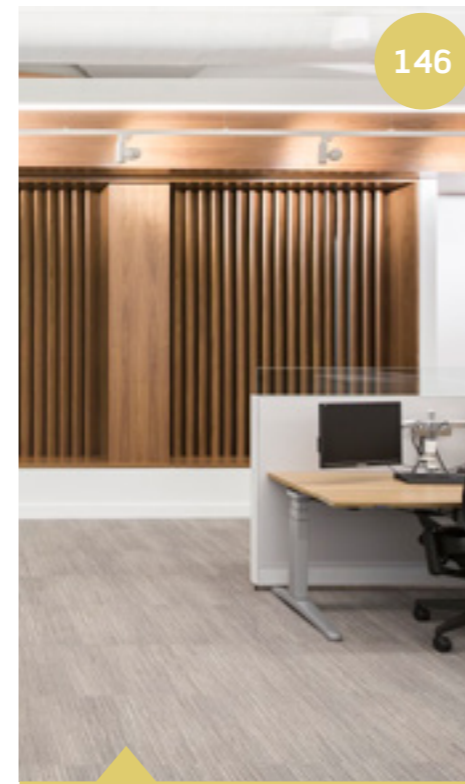

146

LED TRACK LIGHT



156

RESIDENTIAL RECESSED HOUSING



160

LED RETROFIT



173

RECESSED HOUSING



200

LED CEILING LIGHT



206

LED WALL SCONCE



210

LED CABINET LIGHT



216





































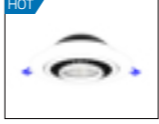

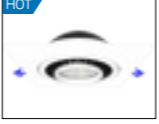













LED HIGH BAY LIGHT

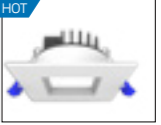

222

LED BULB

ROTATABLE LED EYEBALL DOWNLIGHT

 BL2-B 30	 BL2-B-NC 30	 BL2-B-S 31	 BL2-B-S-NC 31	 BL2-A-01 32	 BL2-A-01-NC 32	 BL2-A-S01 33	 BL2-A-S01-NC 33
 BL2-A-02 34	 BL2-A-02-NC 34	 BL2-A-S02 35	 BL2-A-S02-NC 35	 BL201X-A Series 36	 BL201X-A-S Series 37		
 BL3-B 38	 BL3-B-NC 38	 BL3-B-S 39	 BL3-B-S-NC 39	 BL3-A-01 40	 BL3-A-01-NC 40	 BL3-A-S01 41	 BL3-A-S01-NC 41
 BL3-A-02 42	 BL3-A-02-NC 42	 BL3-A-S02 43	 BL3-A-S02-NC 43				
 BL4-B 44	 BL4-B-NC 44	 BL4-B-S 45	 BL4-B-S-NC 45	 BL4-A-01 46	 BL4-A-01-NC 46	 BL4-A-S01 47	 BL4-A-S01-NC 47
 BL4-A-02 48	 BL4-A-02-NC 48	 BL4-A-S02 49	 BL4-A-S02-NC 49	 BL401X-A Series 50	 BL401X-A-S Series 51		
 BL2-A-01 54	 BL2-A-01-NC 54	 BL2-A-S01 55	 BL2-A-S01-NC 55	 BL3-A-01 56	 BL3-A-01-NC 56	 BL3-A-S01 57	 BL3-A-S01-NC 57
 BL4-A-01 58	 BL4-A-01-NC 58	 BL4-A-S01 59	 BL4-A-S01-NC 59				

MINIATURE LED RECESSED DOWNLIGHT

 BL1-001 64	 BL1-001-NC 64	 BL1-S001 65	 BL1-S001-NC 65	 BL2-001 66	 BL2-001-NC 66	 BL2-S001 67	 BL2-S001-NC 67
 BL1-001-IA 68	 BL1-S001-IA 69	 BL2-001-IA 70	 BL1-S001-NC 71	 G211X-P Series 72	 G211X-P-S Series 73		

LED DOWNLIGHT SERIES

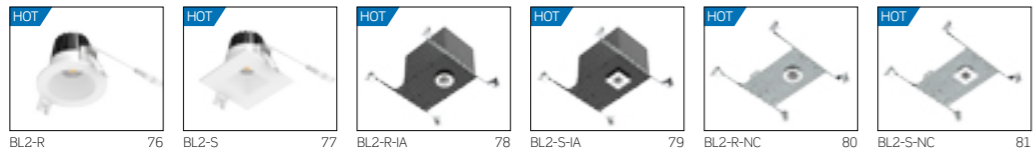

LED RECESSED PANEL LIGHT

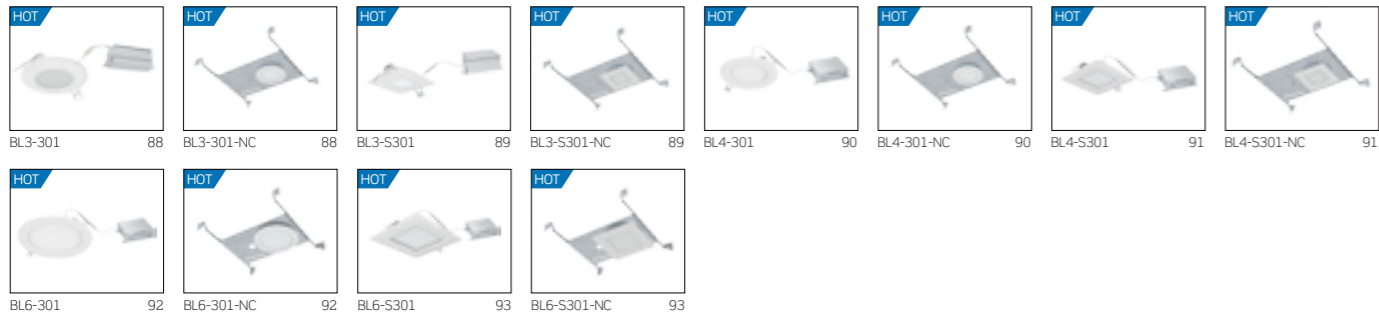

GIMBAL LED RECESSED PANEL LIGHT

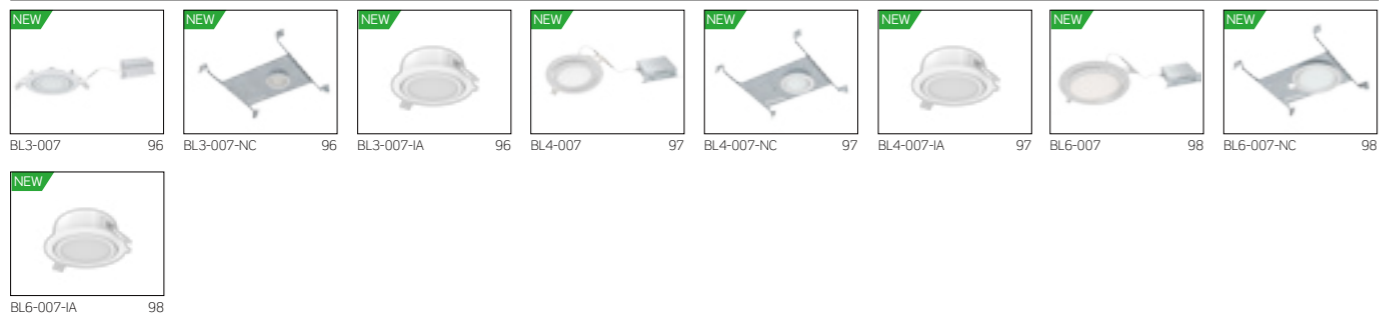

SLEEK DESIGN LED DOME LIGHT SERIES

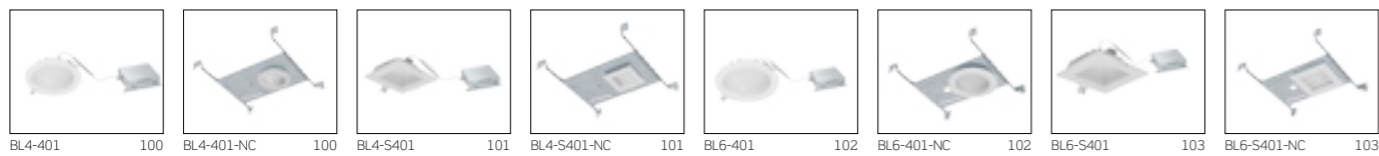

ARTISTIC DESIGN LED RETROFIT TRIM



ARTISTIC DESIGN LED RETROFIT TRIM



LED LINEAR/WRAP LIGHT

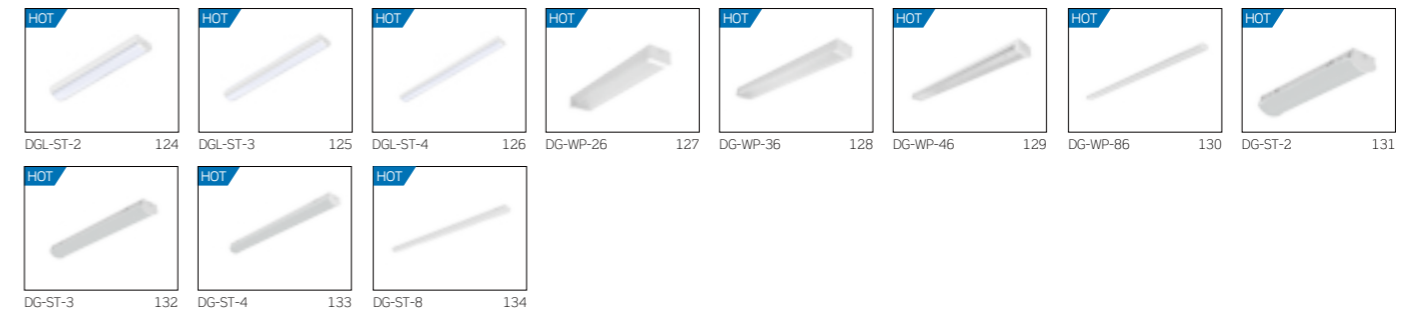

T8 LINEAR LIGHT SERIES

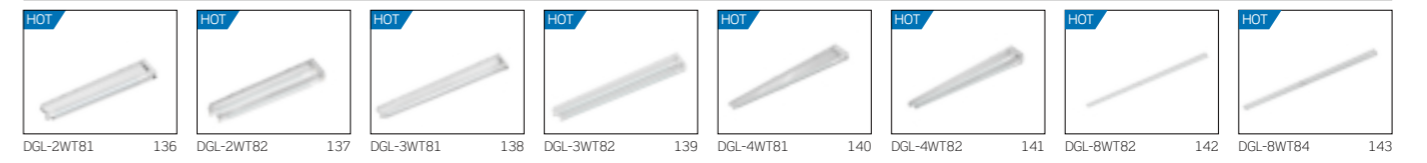

LED TRACK LIGHT

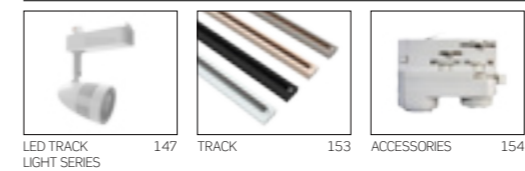

RESIDENTIAL RECESSED HOUSING



LED RETROFIT



LED RETROFIT

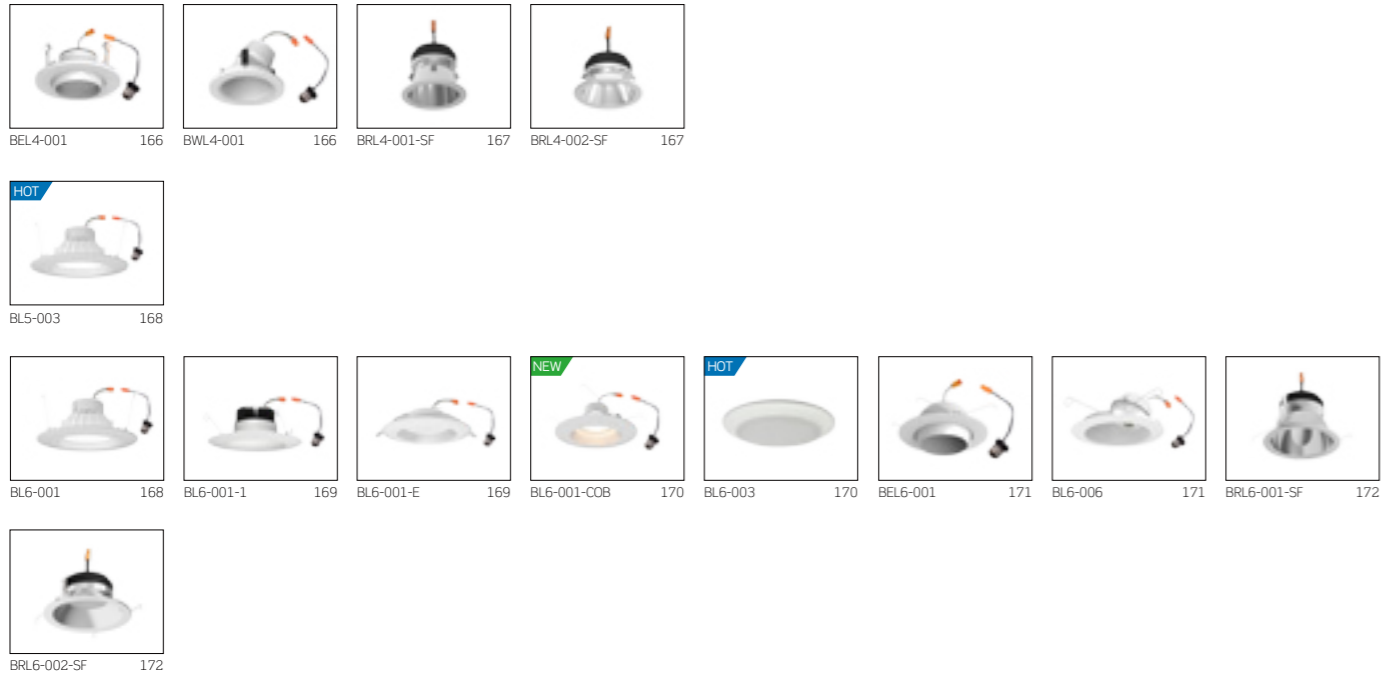

RECESSED HOUSING



RECESSED HOUSING



LED CEILING LIGHT

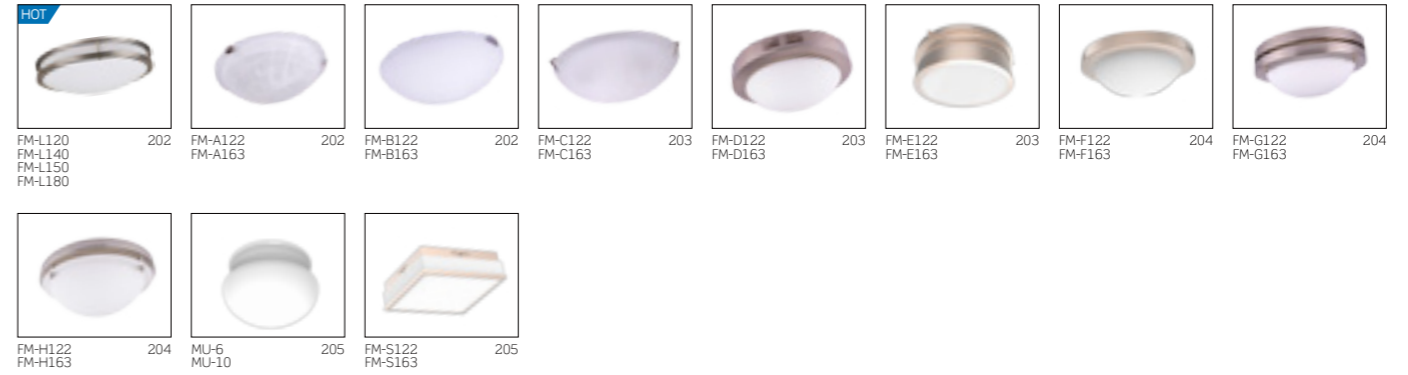

LED WALL SCNCE



LED CABINET LIGHT



LED HIGH BAY LIGHT

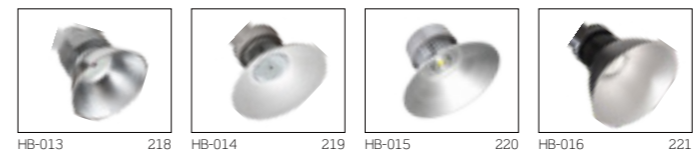

LED BULB



A modern kitchen with stainless steel appliances, granite countertops, and recessed ceiling lights. The kitchen features a large island with a curved granite countertop and a stainless steel sink. The backsplash is made of small, multi-colored mosaic tiles. The cabinets are a light, neutral color with sleek, modern handles. The floor is made of large, light-colored tiles. The lighting is a combination of recessed ceiling lights and under-cabinet lighting. A blue diagonal graphic is overlaid on the left side of the image.

**CLASSIC
RESIDENTIAL
LUMINAIRES**

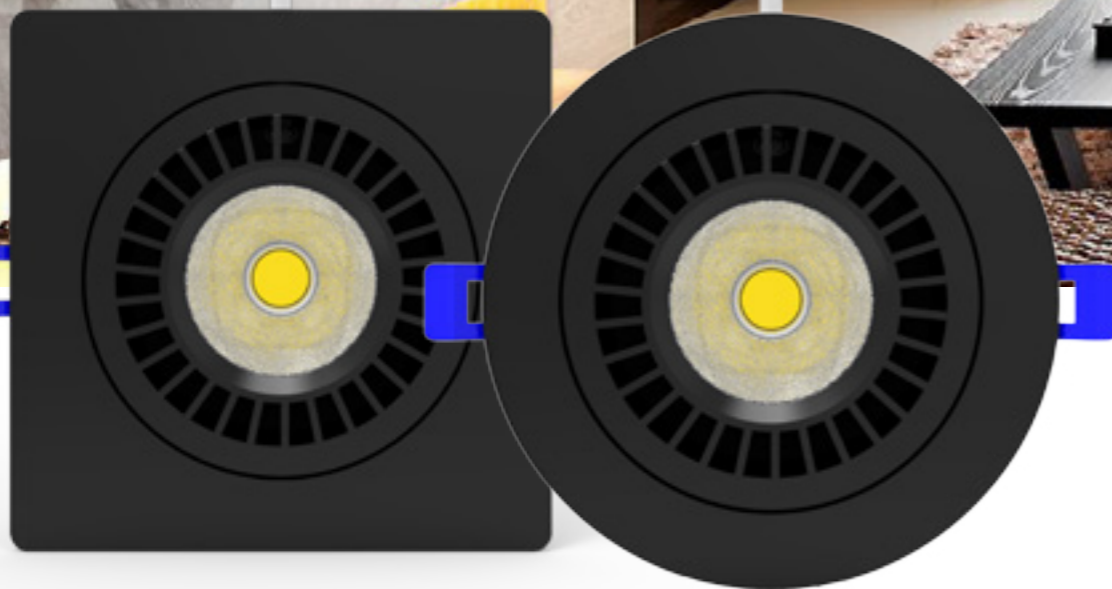

ROTATABLE LED EYEBALL DOWNLIGHT

Liteharbor 2-4 Inch LED Eyeball Downlight features a 30/36° beam angle, so that light can be adjusted towards a piece of artwork or a certain area of interest, while at the same time creates a beautiful hourglass shape. This series is ideal for ambient, decorative, task, and accent lighting.

LED EYEBALL DOWNLIGHT SERIES

A full range of re positioning to highlight your decoration, giving you everything needed to install this beautiful, ultra thin recessed lighting solution.

Installation

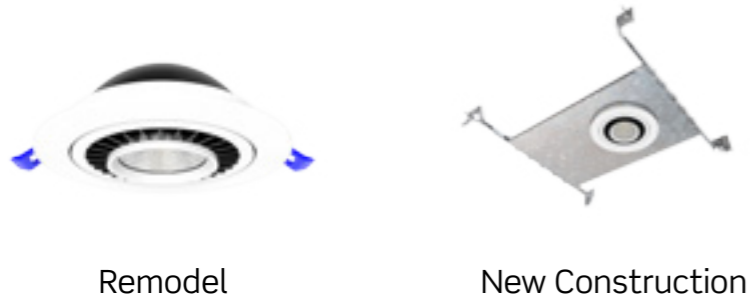

Remodel

New Construction

Types

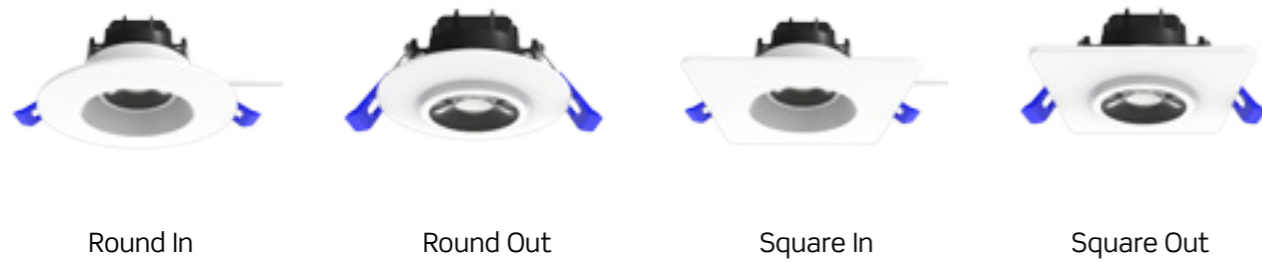

Round In

Round Out

Square In

Square Out

Applications



Hospitality



Office



Retail

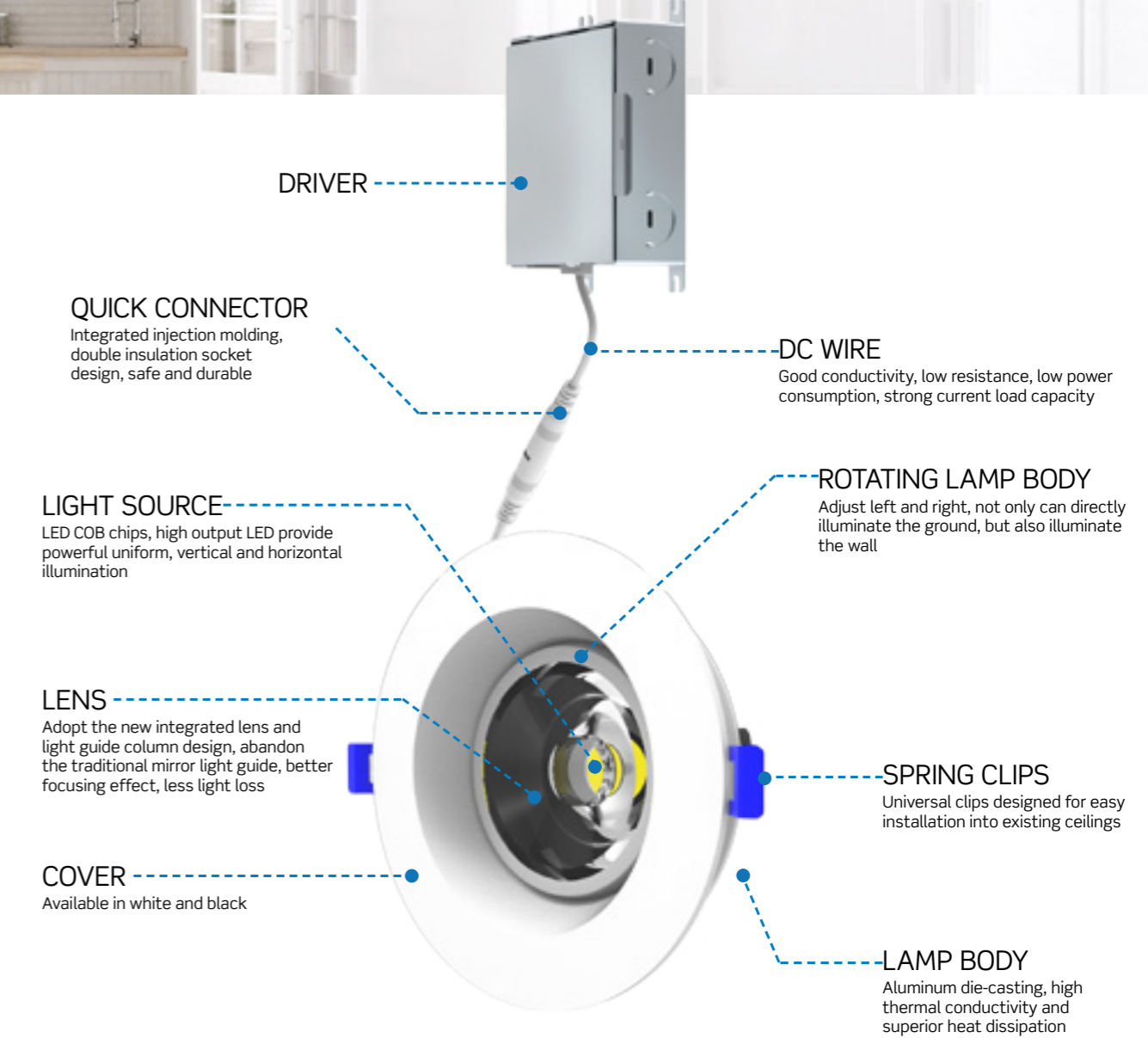

Optional Topics:

Round or square aperture is optional
Available in 2/3/4 inch

Available in remodel and new construction installation
White and black finish colors are optional

2 INCH ROUND SHAPE LED COB EYEBALL DOWNLIGHT



BEL2-B | Remodel

DESCRIPTION

This is a 2" rotatable LED eyeball downlight allow for you to set the ambiance in your space, a full range of repositioning to highlight your decoration, giving you everything needed to install this beautiful, ultra thin recessed lighting solution.

FEATURES

Swivel eyeball trim allows the flexibility focus light on a specific area and create the ambiance you desire.
 Protected LED driver performs at 120V.
 This fixture is built to last with maintenance-free energy efficient LEDs.
 Eyeball can be adjusted to 90 degrees.
 Beam Angle: 30/60 Degree.
 Suitable for damp locations.

APPLICATIONS

Apply to residential, automotive, parking, education, government, healthcare, hospitality, offices and banks, religious, retail.

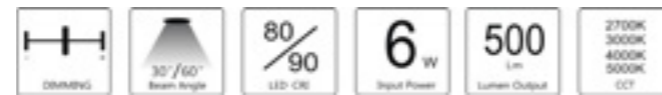

BEL2-B-NC
New Construction

DIMENSIONS

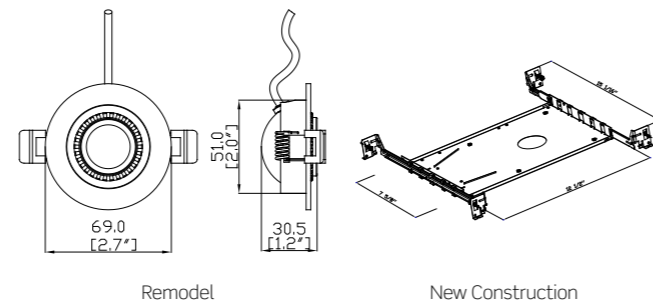

ORDERING GUIDE / YOUR PRODUCT CODE

SERIES	MOUNTING	INPUT VOLTAGE	Watt	CCT	DIMMABLE	FINISH
○ BEL2-B LED Eyeball Downlight	○ Remodel ○ New Construction	○ 120V	○ 6W	○ 2700K ○ 3000K ○ 4000K ○ 5000K	○ Non-Dimmable ○ Dimmable	○ White ○ Black

* Customized Also Available

LISTING / WARRANTY

ETL listed to US and Canadian standards for damp location W/Feed through.
 3 Years Limited Warranty.

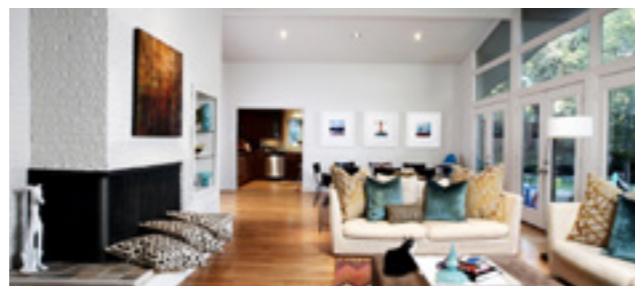

2 INCH SQUARE SHAPE LED COB EYEBALL DOWNLIGHT



BEL2-B-S | Remodel

DESCRIPTION

This is a 2" rotatable LED eyeball downlight allow for you to set the ambiance in your space, a full range of repositioning to highlight your decoration, giving you everything needed to install this beautiful, ultra thin recessed lighting solution.

FEATURES

Swivel eyeball trim allows the flexibility focus light on a specific area and create the ambiance you desire.
 Protected LED driver performs at 120V.
 This fixture is built to last with maintenance-free energy efficient LEDs.
 Eyeball can be adjusted to 90 degrees.
 Beam Angle: 30/60 Degree.
 Suitable for damp locations.

APPLICATIONS

Apply to residential, automotive, parking, education, government, healthcare, hospitality, offices and banks, religious, retail.

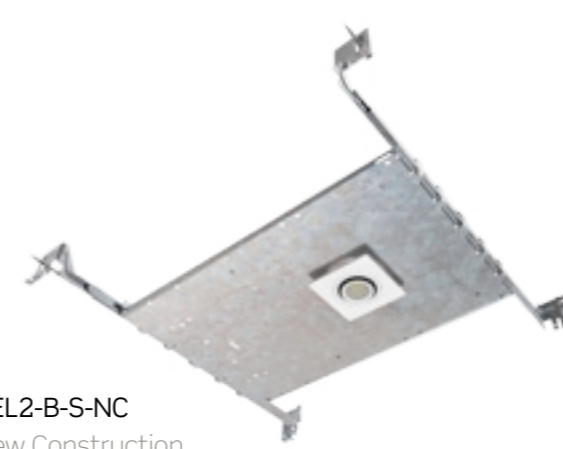

BEL2-B-S-NC
New Construction

DIMENSIONS

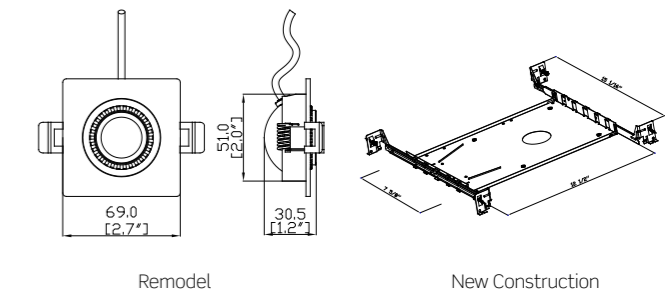

ORDERING GUIDE / YOUR PRODUCT CODE

SERIES	MOUNTING	INPUT VOLTAGE	Watt	CCT	DIMMABLE	FINISH
○ BEL2-B-S LED Eyeball Downlight	○ Remodel ○ New Construction	○ 120V	○ 6W	○ 2700K ○ 3000K ○ 4000K ○ 5000K	○ Non-Dimmable ○ Dimmable	○ White ○ Black

* Customized Also Available

LISTING / WARRANTY

ETL listed to US and Canadian standards for damp location W/Feed through.
 3 Years Limited Warranty.



2 INCH ROUND SHAPE LED EYEBALL DOWNLIGHT

LIGHT SOURCE
COB LED **BEL2-A-01**



DESCRIPTION

This is a 2" rotatable LED eyeball downlight allow for you to set the ambiance in your space, a full range of repositioning to highlight your decoration, giving you everything needed to install this beautiful, ultra thin recessed lighting solution.

FEATURES

Swivel eyeball trim allows the flexibility focus light on a specific area and create the ambiance you desire.
Protected LED driver performs at 120V.
This fixture is built to last with maintenance-free energy efficient LEDs.
Beam Angle: 30/60 Degree.
Suitable for damp locations.

APPLICATIONS

Apply to automotive and parking, education, government, healthcare, hospitality, offices and banks, religious, retail.

BEL2-A-01 | Remodel

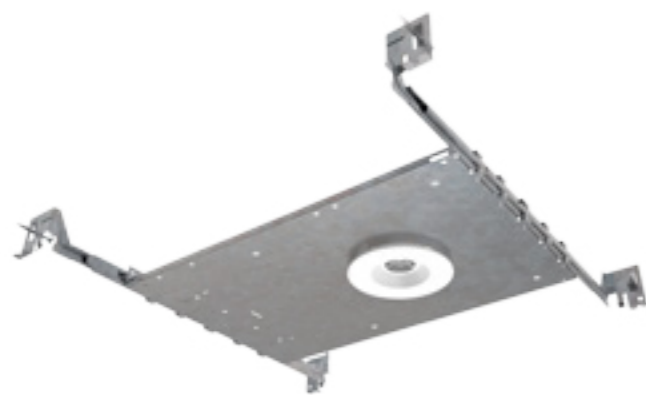

BEL2-A-01-NC
New Construction

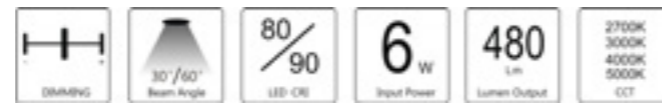

DIMENSIONS

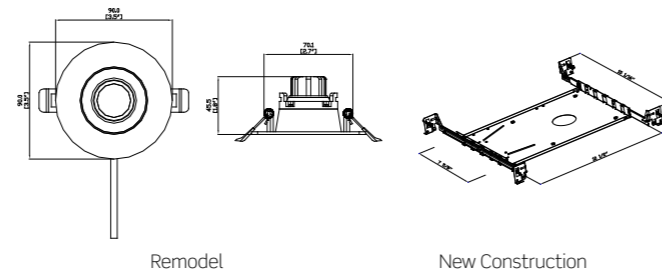

ORDERING GUIDE / YOUR PRODUCT CODE

SERIES	MOUNTING	INPUT VOLTAGE	Watt	CCT	DIMMABLE	FINISH
<input type="radio"/> BEL2-A-01 LED Eyeball Downlight	<input type="radio"/> Remodel <input type="radio"/> New Construction	<input type="radio"/> 120V	<input type="radio"/> 6W	<input type="radio"/> 2700K <input type="radio"/> 3000K <input type="radio"/> 4000K <input type="radio"/> 5000K	<input type="radio"/> Non-Dimmable <input type="radio"/> Dimmable	<input type="radio"/> White <input type="radio"/> Black

* Customized Also Available

LISTING / WARRANTY

ETL listed to US and Canadian standards for damp location W/Feed through.
3 Years Limited Warranty.



2 INCH SQUARE SHAPE LED EYEBALL DOWNLIGHT

LIGHT SOURCE
COB LED **BEL2-A-S01**



DESCRIPTION

This is a 2" rotatable LED eyeball downlight allow for you to set the ambiance in your space, a full range of repositioning to highlight your decoration, giving you everything needed to install this beautiful, ultra thin recessed lighting solution.

FEATURES

Swivel eyeball trim allows the flexibility focus light on a specific area and create the ambiance you desire.
Protected LED driver performs at 120V.
This fixture is built to last with maintenance-free energy efficient LEDs.
Beam Angle: 30/60 Degree.
Suitable for damp locations.

APPLICATIONS

Apply to automotive and parking, education, government, healthcare, hospitality, offices and banks, religious, retail.

BEL2-A-S01 | Remodel

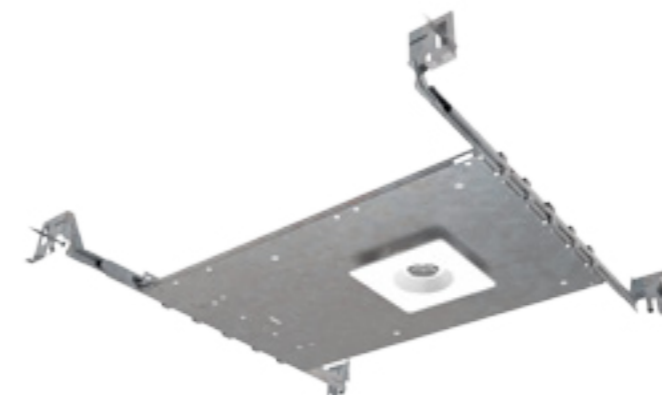

BEL2-A-S01-NC
New Construction



DIMENSIONS

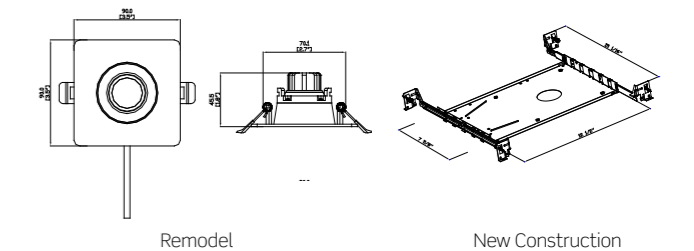

ORDERING GUIDE / YOUR PRODUCT CODE

SERIES	MOUNTING	INPUT VOLTAGE	Watt	CCT	DIMMABLE	FINISH
<input type="radio"/> BEL2-A-S01 LED Eyeball Downlight	<input type="radio"/> Remodel <input type="radio"/> New Construction	<input type="radio"/> 120V	<input type="radio"/> 6W	<input type="radio"/> 2700K <input type="radio"/> 3000K <input type="radio"/> 4000K <input type="radio"/> 5000K	<input type="radio"/> Non-Dimmable <input type="radio"/> Dimmable	<input type="radio"/> White <input type="radio"/> Black

* Customized Also Available

LISTING / WARRANTY

ETL listed to US and Canadian standards for damp location W/Feed through.
3 Years Limited Warranty.



2 INCH ROUND SHAPE LED EYEBALL DOWNLIGHT

BEL2-A-02



DESCRIPTION

This is a 2" rotatable LED eyeball downlight allow for you to set the ambiance in your space, a full range of repositioning to highlight your decoration, giving you everything needed to install this beautiful, ultra thin recessed lighting solution.

FEATURES

Swivel eyeball trim allows the flexibility focus light on a specific area and create the ambiance you desire.
Protected LED driver performs at 120V.
This fixture is built to last with maintenance-free energy efficient LEDs.
Beam Angle: 30/60 Degree.
Suitable for damp locations.

APPLICATIONS

Apply to automotive and parking, education, government, healthcare, hospitality, offices and banks, religious, retail.

BEL2-A-02 | Remodel



BEL2-A-02-NC
New Construction

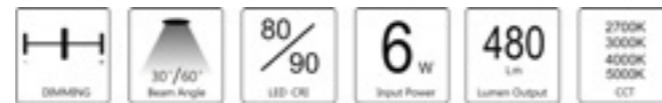

DIMENSIONS

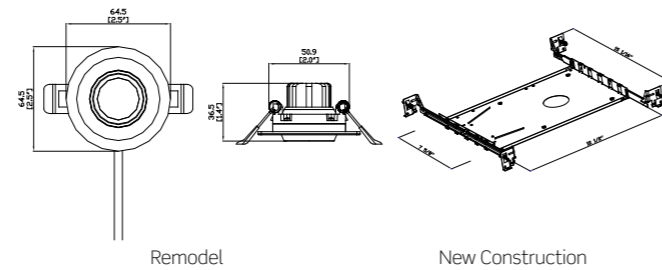

ORDERING GUIDE / YOUR PRODUCT CODE

SERIES	MOUNTING	INPUT VOLTAGE	Watt	CCT	DIMMABLE	FINISH
<input type="radio"/> BEL2-A-02 LED Eyeball Downlight	<input type="radio"/> Remodel <input type="radio"/> New Construction	<input type="radio"/> 120V	<input type="radio"/> 6W	<input type="radio"/> 2700K <input type="radio"/> 3000K <input type="radio"/> 4000K <input type="radio"/> 5000K	<input type="radio"/> Non-Dimmable <input type="radio"/> Dimmable	<input type="radio"/> White <input type="radio"/> Black

* Customized Also Available

LISTING / WARRANTY

ETL listed to US and Canadian standards for damp location W/Feed through.
3 Years Limited Warranty.



2 INCH SQUARE SHAPE LED EYEBALL DOWNLIGHT

BEL2-A-S02



DESCRIPTION

This is a 2" rotatable LED eyeball downlight allow for you to set the ambiance in your space, a full range of repositioning to highlight your decoration, giving you everything needed to install this beautiful, ultra thin recessed lighting solution.

FEATURES

Swivel eyeball trim allows the flexibility focus light on a specific area and create the ambiance you desire.
Protected LED driver performs at 120V.
This fixture is built to last with maintenance-free energy efficient LEDs.
Beam Angle: 30/60 Degree.
Suitable for damp locations.

APPLICATIONS

Apply to automotive and parking, education, government, healthcare, hospitality, offices and banks, religious, retail.

BEL2-A-S02 | Remodel



BEL2-A-S02-NC
New Construction



DIMENSIONS

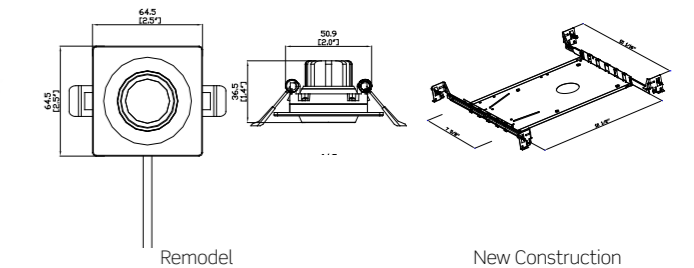

ORDERING GUIDE / YOUR PRODUCT CODE

SERIES	MOUNTING	INPUT VOLTAGE	Watt	CCT	DIMMABLE	FINISH
<input type="radio"/> BEL2-A-S02 LED Eyeball Downlight	<input type="radio"/> Remodel <input type="radio"/> New Construction	<input type="radio"/> 120V	<input type="radio"/> 6W	<input type="radio"/> 2700K <input type="radio"/> 3000K <input type="radio"/> 4000K <input type="radio"/> 5000K	<input type="radio"/> Non-Dimmable <input type="radio"/> Dimmable	<input type="radio"/> White <input type="radio"/> Black

* Customized Also Available

LISTING / WARRANTY

ETL listed to US and Canadian standards for damp location W/Feed through.
3 Years Limited Warranty.

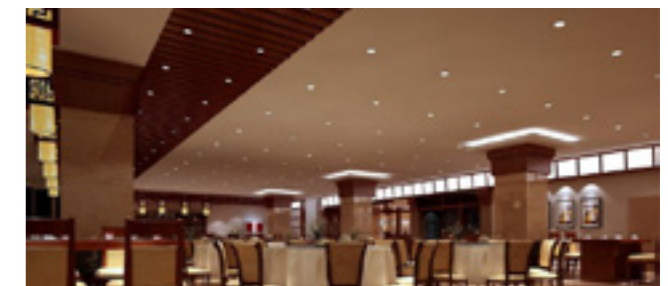

2 INCH ROUND SHAPE LED EYEBALL MULTIPLE DOWNLIGHT

LIGHT SOURCE COB LED BEL201X-A Series



DESCRIPTION

This is a 2" rotatable LED eyeball multiple downlight allow for you to set the ambiance in your space, a full range of repositioning to highlight your decoration, giving you everything needed to install this beautiful, ultra thin recessed lighting solution.

FEATURES

Swivel eyeball trim allows the flexibility focus light on a specific area and create the ambiance you desire.
 Protected LED driver performs at 120V/120~277V.
 This fixture is built to last with maintenance-free energy efficient LEDs.
 Available in 1, 2, 3, 4 lamps.
 Beam Angle: 30/60 Degree.
 Suitable for damp location.

APPLICATIONS

Apply to automotive and parking, education, government, healthcare, hospitality, offices and banks, religious, retail.



LISTING / WARRANTY

ETL listed to US and Canadian standards for damp location W/Feed through.
 3 Years Limited Warranty.



DIMENSIONS

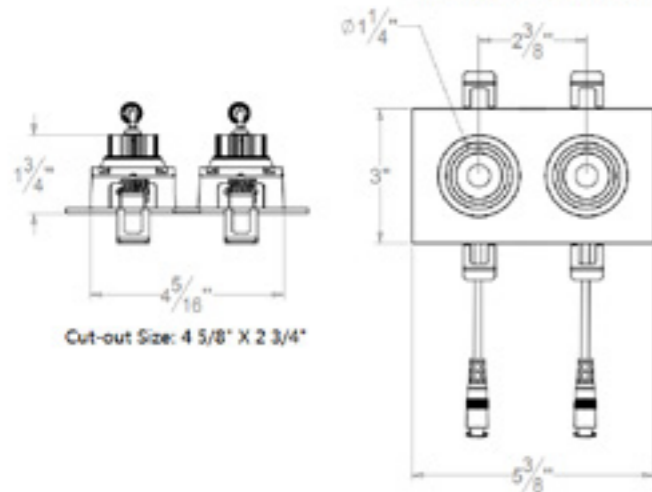

BEL2012-A-01
 L: 5 3/8"xW: 3"xH: 1 3/4"
 Cut-Out: 4 5/8" x 2 3/4"

BEL2013-A-01
 L: 7 13/16"xW: 3"xH: 1 3/4"
 Cut-Out: 7" x 2 3/4"

BEL2014-A-01
 L: 10 3/16"xW: 3"xH: 1 3/4"
 Cut-Out: 9 5/8" x 2 3/4"

BEL2012-A-02
 L: 4 3/8"xW: 2 3/8"xH: 1 5/16"
 Cut-Out: 4 1/8" x 2"

BEL2013-A-02
 L: 6 7/16"xW: 2 3/8"xH: 1 5/16"
 Cut-Out: 6 1/4" x 2"

BEL2014-A-02
 L: 8 1/2"xW: 2 3/8"xH: 1 5/16"
 Cut-Out: 8 1/4" x 2"

ORDERING GUIDE / YOUR PRODUCT CODE

SERIES	VOLTAGE	WATT	CCT	FINISH	CRI	BEAM ANGLE
<input type="radio"/> BEL2012-A-01	<input type="radio"/> 120V	<input type="radio"/> 6W/lamp	<input type="radio"/> 2700K	<input type="radio"/> Black	<input type="radio"/> 80+	<input type="radio"/> 30°
<input type="radio"/> BEL2012-A-02	<input type="radio"/> 120~277V		<input type="radio"/> 3000K	<input type="radio"/> White	<input type="radio"/> 90+	<input type="radio"/> 60°
<input type="radio"/> BEL2013-A-01			<input type="radio"/> 4000K			
<input type="radio"/> BEL2013-A-02			<input type="radio"/> 5000K			
<input type="radio"/> BEL2014-A-01						
<input type="radio"/> BEL2014-A-02						

2" LED Eyeball Multiple Downlight

* Customized Also Available

2 INCH SQUARE SHAPE LED EYEBALL MULTIPLE DOWNLIGHT

LIGHT SOURCE COB LED BEL201X-A-S Series

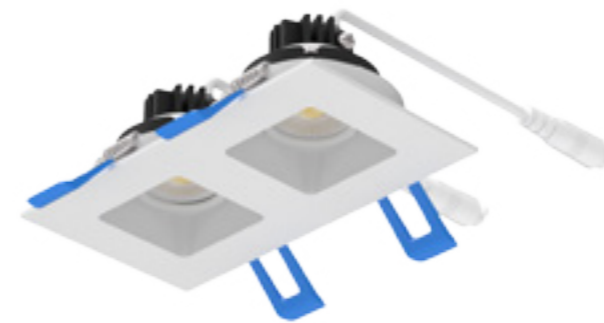

DESCRIPTION

This is a 2" rotatable LED eyeball multiple downlight allow for you to set the ambiance in your space, a full range of repositioning to highlight your decoration, giving you everything needed to install this beautiful, ultra thin recessed lighting solution.

FEATURES

Swivel eyeball trim allows the flexibility focus light on a specific area and create the ambiance you desire.
 Protected LED driver performs at 120V/120~277V.
 This fixture is built to last with maintenance-free energy efficient LEDs.
 Available in 1, 2, 3, 4 lamps.
 Beam Angle: 30/60 Degree.
 Suitable for damp location.

APPLICATIONS

Apply to automotive and parking, education, government, healthcare, hospitality, offices and banks, religious, retail.



LISTING / WARRANTY

ETL listed to US and Canadian standards for damp location W/Feed through.
 3 Years Limited Warranty.



DIMENSIONS

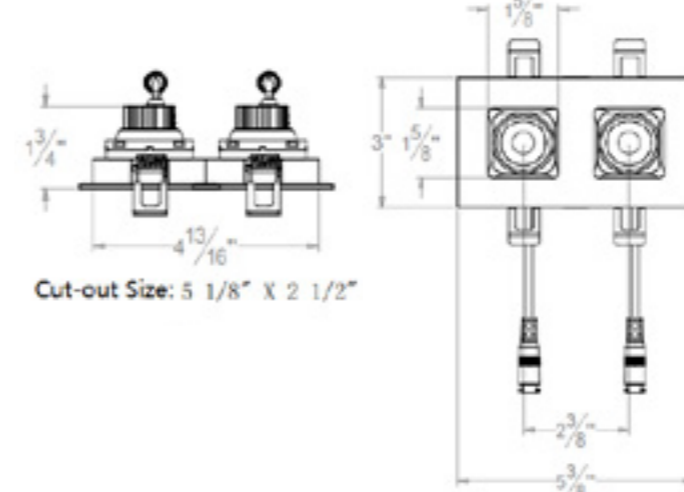

BEL2012-A-S01
 L: 5 3/8"xW: 3"xH: 1 3/4"
 Cut-Out: 5 1/8" x 2 1/2"

BEL2013-A-S01
 L: 7 13/16"xW: 3"xH: 1 3/4"
 Cut-Out: 7 1/2" x 2 1/2"

BEL2014-A-S01
 L: 10 3/16"xW: 3"xH: 1 3/4"
 Cut-Out: 9 7/8" x 2 1/2"

ORDERING GUIDE / YOUR PRODUCT CODE

SERIES	VOLTAGE	WATT	CCT	FINISH	CRI	BEAM ANGLE
<input type="radio"/> BEL2012-A-S01	<input type="radio"/> 120V	<input type="radio"/> 6W/lamp	<input type="radio"/> 2700K	<input type="radio"/> Black	<input type="radio"/> 80+	<input type="radio"/> 30°
<input type="radio"/> BEL2013-A-S01	<input type="radio"/> 120~277V		<input type="radio"/> 3000K	<input type="radio"/> White	<input type="radio"/> 90+	<input type="radio"/> 60°
<input type="radio"/> BEL2014-A-S01			<input type="radio"/> 4000K			
			<input type="radio"/> 5000K			

2" LED Eyeball Multiple Downlight

* Customized Also Available

3 INCH ROUND SHAPE LED COB EYEBALL DOWNLIGHT



BEL3-B | Remodel

DESCRIPTION

This is a 3" rotatable LED eyeball downlight allow for you to set the ambiance in your space, a full range of repositioning to highlight your decoration, giving you everything needed to install this beautiful, ultra thin recessed lighting solution.

FEATURES

Swivel eyeball trim allows the flexibility focus light on a specific area and create the ambiance you desire.
 Protected LED driver performs at 120V.
 This fixture is built to last with maintenance-free energy efficient LEDs.
 Eyeball can be adjusted to 90 degrees.
 Beam Angle: 30/60 Degree.
 Suitable for damp locations.

APPLICATIONS

Apply to residential, automotive, parking, education, government, healthcare, hospitality, offices and banks, religious, retail.

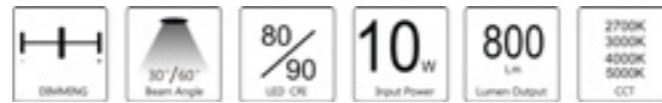

DIMENSIONS

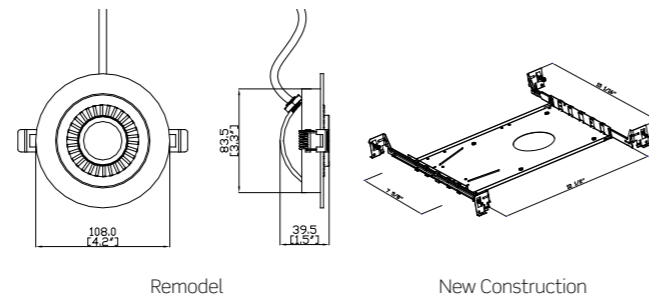

Remodel

New Construction



BEL3-B-NC
New Construction

ORDERING GUIDE / YOUR PRODUCT CODE

SERIES	MOUNTING	INPUT VOLTAGE	Watt	CCT	DIMMABLE	FINISH
<input type="radio"/> BEL3-B LED Eyeball Downlight	<input type="radio"/> Remodel <input type="radio"/> New Construction	<input type="radio"/> 120V	<input type="radio"/> 10W	<input type="radio"/> 2700K <input type="radio"/> 3000K <input type="radio"/> 4000K <input type="radio"/> 5000K	<input type="radio"/> Non-Dimmable <input type="radio"/> Dimmable	<input type="radio"/> White <input type="radio"/> Black

* Customized Also Available

LISTING / WARRANTY

ETL listed to US and Canadian standards for damp location W/Feed through.
 3 Years Limited Warranty.



3 INCH SQUARE SHAPE LED COB EYEBALL DOWNLIGHT



BEL3-B-S | Remodel

DESCRIPTION

This is a 3" rotatable LED eyeball downlight allow for you to set the ambiance in your space, a full range of repositioning to highlight your decoration, giving you everything needed to install this beautiful, ultra thin recessed lighting solution.

FEATURES

Swivel eyeball trim allows the flexibility focus light on a specific area and create the ambiance you desire.
 Protected LED driver performs at 120V.
 This fixture is built to last with maintenance-free energy efficient LEDs.
 Eyeball can be adjusted to 90 degrees.
 Beam Angle: 30/60 Degree.
 Suitable for damp locations.

APPLICATIONS

Apply to residential, automotive, parking, education, government, healthcare, hospitality, offices and banks, religious, retail.



DIMENSIONS

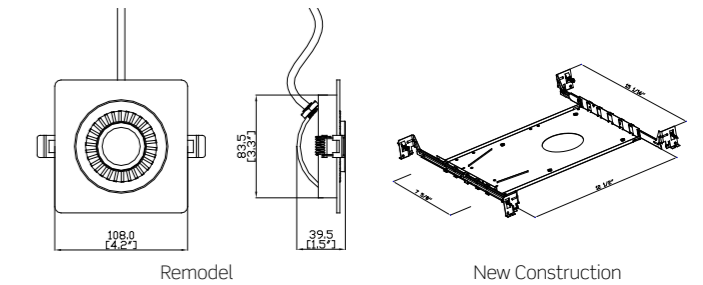

Remodel

New Construction



BEL3-B-S-NC
New Construction

ORDERING GUIDE / YOUR PRODUCT CODE

SERIES	MOUNTING	INPUT VOLTAGE	Watt	CCT	DIMMABLE	FINISH
<input type="radio"/> BEL3-B-S LED Eyeball Downlight	<input type="radio"/> Remodel <input type="radio"/> New Construction	<input type="radio"/> 120V	<input type="radio"/> 10W	<input type="radio"/> 2700K <input type="radio"/> 3000K <input type="radio"/> 4000K <input type="radio"/> 5000K	<input type="radio"/> Non-Dimmable <input type="radio"/> Dimmable	<input type="radio"/> White <input type="radio"/> Black

* Customized Also Available

LISTING / WARRANTY

ETL listed to US and Canadian standards for damp location W/Feed through.
 3 Years Limited Warranty.

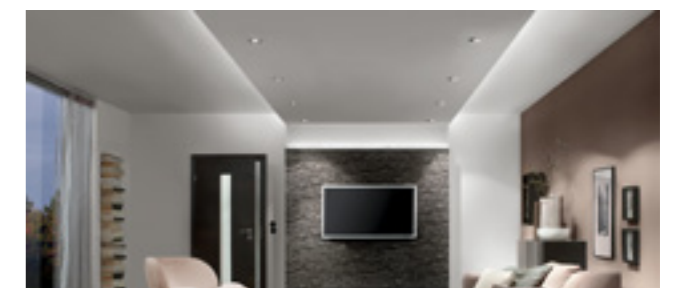

3 INCH ROUND SHAPE LED EYEBALL DOWNLIGHT

LIGHT SOURCE
COB LED **BEL3-A-01**



BEL3-A-01 | Remodel

DESCRIPTION

This is a 3" rotatable LED eyeball downlight allow for you to set the ambiance in your space, a full range of repositioning to highlight your decoration, giving you everything needed to install this beautiful, ultra thin recessed lighting solution.

FEATURES

Swivel eyeball trim allows the flexibility focus light on a specific area and create the ambiance you desire.
Protected LED driver performs at 120V.
This fixture is built to last with maintenance-free energy efficient LEDs.
Beam Angle: 30/60 Degree.
Suitable for damp locations.

APPLICATIONS

Apply to automotive and parking, education, government, healthcare, hospitality, offices and banks, religious, retail.

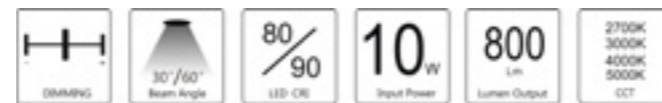

DIMENSIONS

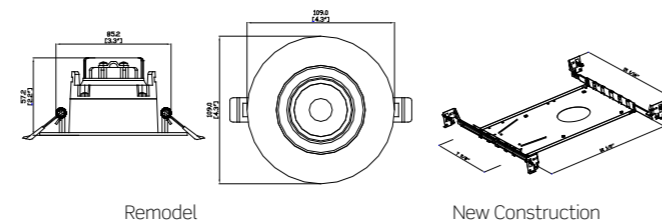

BEL3-A-01-NC
New Construction

ORDERING GUIDE / YOUR PRODUCT CODE

SERIES	MOUNTING	INPUT VOLTAGE	Watt	CCT	DIMMABLE	FINISH
<input type="radio"/> BEL3-A-01 LED Eyeball Downlight	<input type="radio"/> Remodel <input type="radio"/> New Construction	<input type="radio"/> 120V	<input type="radio"/> 10W	<input type="radio"/> 2700K <input type="radio"/> 3000K <input type="radio"/> 4000K <input type="radio"/> 5000K	<input type="radio"/> Non-Dimmable <input type="radio"/> Dimmable	<input type="radio"/> White <input type="radio"/> Black

* Customized Also Available

LISTING / WARRANTY

ETL listed to US and Canadian standards for damp location W/Feed through.
3 Years Limited Warranty.



3 INCH SQUARE SHAPE LED EYEBALL DOWNLIGHT

LIGHT SOURCE
COB LED **BEL3-A-S01**



BEL3-A-S01 | Remodel

DESCRIPTION

This is a 3" rotatable LED eyeball downlight allow for you to set the ambiance in your space, a full range of repositioning to highlight your decoration, giving you everything needed to install this beautiful, ultra thin recessed lighting solution.

FEATURES

Swivel eyeball trim allows the flexibility focus light on a specific area and create the ambiance you desire.
Protected LED driver performs at 120V.
This fixture is built to last with maintenance-free energy efficient LEDs.
Beam Angle: 30/60 Degree.
Suitable for damp locations.

APPLICATIONS

Apply to automotive and parking, education, government, healthcare, hospitality, offices and banks, religious, retail.



DIMENSIONS

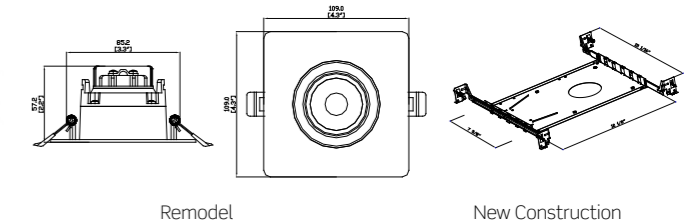

BEL3-A-S01-NC
New Construction

ORDERING GUIDE / YOUR PRODUCT CODE

SERIES	MOUNTING	INPUT VOLTAGE	Watt	CCT	DIMMABLE	FINISH
<input type="radio"/> BEL3-A-S01 LED Eyeball Downlight	<input type="radio"/> Remodel <input type="radio"/> New Construction	<input type="radio"/> 120V	<input type="radio"/> 10W	<input type="radio"/> 2700K <input type="radio"/> 3000K <input type="radio"/> 4000K <input type="radio"/> 5000K	<input type="radio"/> Non-Dimmable <input type="radio"/> Dimmable	<input type="radio"/> White <input type="radio"/> Black

* Customized Also Available

LISTING / WARRANTY

ETL listed to US and Canadian standards for damp location W/Feed through.
3 Years Limited Warranty.



3 INCH ROUND SHAPE LED EYEBALL DOWNLIGHT

LIGHT SOURCE
COB LED **BEL3-A-02**



BEL3-A-02 | Remodel

DESCRIPTION

This is a 3" rotatable LED eyeball downlight allow for you to set the ambiance in your space, a full range of repositioning to highlight your decoration, giving you everything needed to install this beautiful, ultra thin recessed lighting solution.

FEATURES

Swivel eyeball trim allows the flexibility focus light on a specific area and create the ambiance you desire.
Protected LED driver performs at 120V.
This fixture is built to last with maintenance-free energy efficient LEDs.
Beam Angle: 30/60 Degree.
Suitable for damp locations.

APPLICATIONS

Apply to automotive and parking, education, government, healthcare, hospitality, offices and banks, religious, retail.

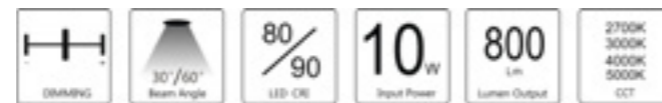

DIMENSIONS

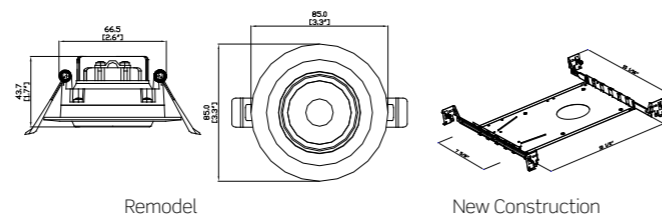

BEL3-A-02-NC
New Construction

ORDERING GUIDE / YOUR PRODUCT CODE

SERIES	MOUNTING	INPUT VOLTAGE	Watt	CCT	DIMMABLE	FINISH
<input type="radio"/> BEL3-A-02 LED Eyeball Downlight	<input type="radio"/> Remodel <input type="radio"/> New Construction	<input type="radio"/> 120V	<input type="radio"/> 10W	<input type="radio"/> 2700K <input type="radio"/> 3000K <input type="radio"/> 4000K <input type="radio"/> 5000K	<input type="radio"/> Non-Dimmable <input type="radio"/> Dimmable	<input type="radio"/> White <input type="radio"/> Black

* Customized Also Available

LISTING / WARRANTY

ETL listed to US and Canadian standards for damp location W/Feed through.
3 Years Limited Warranty.



3 INCH SQUARE SHAPE LED EYEBALL DOWNLIGHT

LIGHT SOURCE
COB LED **BEL3-A-S02**



BEL3-A-S02 | Remodel

DESCRIPTION

This is a 3" rotatable LED eyeball downlight allow for you to set the ambiance in your space, a full range of repositioning to highlight your decoration, giving you everything needed to install this beautiful, ultra thin recessed lighting solution.

FEATURES

Swivel eyeball trim allows the flexibility focus light on a specific area and create the ambiance you desire.
Protected LED driver performs at 120V.
This fixture is built to last with maintenance-free energy efficient LEDs.
Beam Angle: 30/60 Degree.
Suitable for damp locations.

APPLICATIONS

Apply to automotive and parking, education, government, healthcare, hospitality, offices and banks, religious, retail.



DIMENSIONS

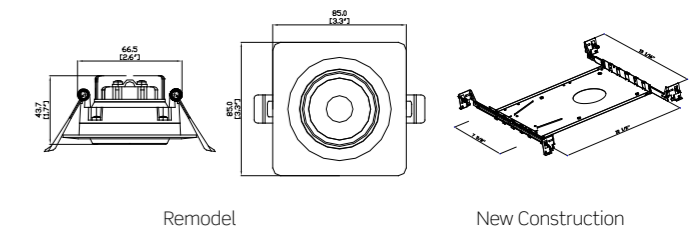

BEL3-A-S02-NC
New Construction

ORDERING GUIDE / YOUR PRODUCT CODE

SERIES	MOUNTING	INPUT VOLTAGE	Watt	CCT	DIMMABLE	FINISH
<input type="radio"/> BEL3-A-S02 LED Eyeball Downlight	<input type="radio"/> Remodel <input type="radio"/> New Construction	<input type="radio"/> 120V	<input type="radio"/> 10W	<input type="radio"/> 2700K <input type="radio"/> 3000K <input type="radio"/> 4000K <input type="radio"/> 5000K	<input type="radio"/> Non-Dimmable <input type="radio"/> Dimmable	<input type="radio"/> White <input type="radio"/> Black

* Customized Also Available

LISTING / WARRANTY

ETL listed to US and Canadian standards for damp location W/Feed through.
3 Years Limited Warranty.



4 INCH ROUND SHAPE LED COB EYEBALL DOWNLIGHT



BEL4-B | Remodel

DESCRIPTION

This is a 4" rotatable LED eyeball downlight allow for you to set the ambience in your space, a full range of repositioning to highlight your decoration, giving you everything needed to install this beautiful, ultra thin recessed lighting solution.

FEATURES

Swivel eyeball trim allows the flexibility focus light on a specific area and create the ambience you desire.
 Dimming: TRAC Dimming, (0-10V dimming for 120-277V).
 Protected LED driver performs at 120V (120-277V available).
 This fixture is built to last with maintenance-free energy efficient LEDs.
 Eyeball can be adjusted to 90 degrees.
 Beam Angle: 30/60 Degree.
 Suitable for damp locations.

APPLICATIONS

Apply to residential, automotive, parking, education, government, healthcare, hospitality, offices and banks, religious, retail.



DIMENSIONS

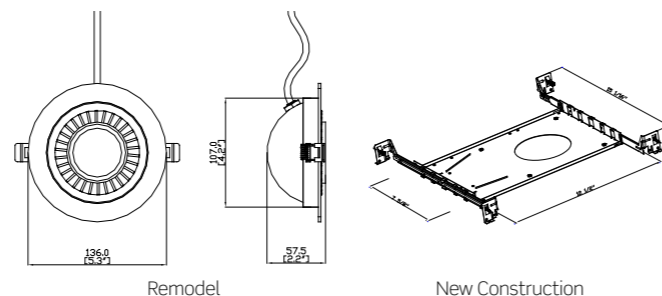

BEL4-B-NC
New Construction

ORDERING GUIDE / YOUR PRODUCT CODE

SERIES	MOUNTING	INPUT VOLTAGE	Watt	CCT	DIMMABLE	FINISH
<input type="radio"/> BEL4-B LED Eyeball Downlight	<input type="radio"/> Remodel <input type="radio"/> New Construction	<input type="radio"/> 120V	<input type="radio"/> 15W	<input type="radio"/> 2700K <input type="radio"/> 3000K <input type="radio"/> 4000K <input type="radio"/> 5000K	<input type="radio"/> Non-Dimmable <input type="radio"/> Dimmable	<input type="radio"/> White <input type="radio"/> Black

* Customized Also Available

LISTING / WARRANTY

ETL listed to US and Canadian standards for damp location W/Feed through.
3 Years Limited Warranty.



4 INCH SQUARE SHAPE LED COB EYEBALL DOWNLIGHT



BEL4-B-S | Remodel

DESCRIPTION

This is a 4" rotatable LED eyeball downlight allow for you to set the ambience in your space, a full range of repositioning to highlight your decoration, giving you everything needed to install this beautiful, ultra thin recessed lighting solution.

FEATURES

Swivel eyeball trim allows the flexibility focus light on a specific area and create the ambience you desire.
 Dimming: TRAC Dimming, (0-10V dimming for 120-277V).
 Protected LED driver performs at 120V (120-277V available).
 This fixture is built to last with maintenance-free energy efficient LEDs.
 Eyeball can be adjusted to 90 degrees.
 Beam Angle: 30/60 Degree.
 Suitable for damp locations.

APPLICATIONS

Apply to residential, automotive, parking, education, government, healthcare, hospitality, offices and banks, religious, retail.



DIMENSIONS

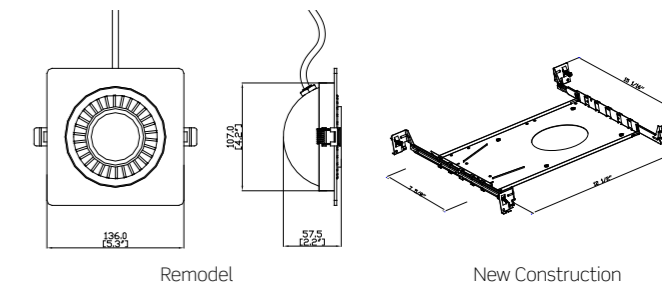

BEL4-B-S-NC
New Construction

ORDERING GUIDE / YOUR PRODUCT CODE

SERIES	MOUNTING	INPUT VOLTAGE	Watt	CCT	DIMMABLE	FINISH
<input type="radio"/> BEL4-B-S LED Eyeball Downlight	<input type="radio"/> Remodel <input type="radio"/> New Construction	<input type="radio"/> 120V	<input type="radio"/> 15W	<input type="radio"/> 2700K <input type="radio"/> 3000K <input type="radio"/> 4000K <input type="radio"/> 5000K	<input type="radio"/> Non-Dimmable <input type="radio"/> Dimmable	<input type="radio"/> White <input type="radio"/> Black

* Customized Also Available

LISTING / WARRANTY

ETL listed to US and Canadian standards for damp location W/Feed through.
3 Years Limited Warranty.



4 INCH ROUND SHAPE LED EYEBALL DOWNLIGHT

LIGHT SOURCE
COB LED **BEL4-A-01**



BEL4-A-01 | Remodel

DESCRIPTION

This is a 4" rotatable LED eyeball downlight allow for you to set the ambiance in your space, a full range of repositioning to highlight your decoration, giving you everything needed to install this beautiful, ultra thin recessed lighting solution.

FEATURES

Swivel eyeball trim allows the flexibility focus light on a specific area and create the ambiance you desire.
Dimming: TRAC Dimming, (0-10V dimming for 120-277V).
Protected LED driver performs at 120V (120-277V available).
This fixture is built to last with maintenance-free energy efficient LEDs.
Beam Angle: 30/60 Degree.
Suitable for damp locations.

APPLICATIONS

Apply to automotive and parking, education, government, healthcare, hospitality, offices and banks, religious, retail.

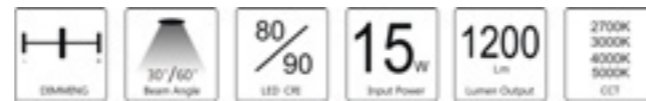

DIMENSIONS

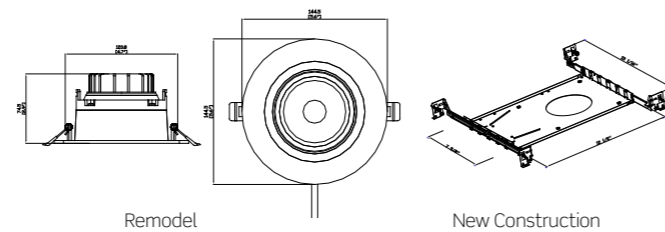

BEL4-A-01-NC
New Construction

ORDERING GUIDE / YOUR PRODUCT CODE

SERIES	MOUNTING	INPUT VOLTAGE	Watt	CCT	DIMMABLE	FINISH
<input type="radio"/> BEL4-A-01 LED Eyeball Downlight	<input type="radio"/> Remodel <input type="radio"/> New Construction	<input type="radio"/> 120V <input type="radio"/> 120-277V	<input type="radio"/> 15W	<input type="radio"/> 2700K <input type="radio"/> 3000K <input type="radio"/> 4000K <input type="radio"/> 5000K	<input type="radio"/> Non-Dimmable <input type="radio"/> Dimmable	<input type="radio"/> White <input type="radio"/> Black

* Customized Also Available

LISTING / WARRANTY

ETL listed to US and Canadian standards for damp location W/Feed through.
3 Years Limited Warranty.



4 INCH SQUARE SHAPE LED EYEBALL DOWNLIGHT

LIGHT SOURCE
COB LED **BEL4-A-S01**

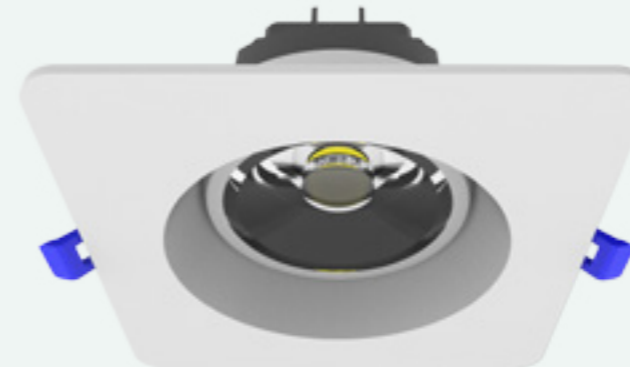

BEL4-A-S01 | Remodel

DESCRIPTION

This is a 4" rotatable LED eyeball downlight allow for you to set the ambiance in your space, a full range of repositioning to highlight your decoration, giving you everything needed to install this beautiful, ultra thin recessed lighting solution.

FEATURES

Swivel eyeball trim allows the flexibility focus light on a specific area and create the ambiance you desire.
Dimming: TRAC Dimming, (0-10V dimming for 120-277V).
Protected LED driver performs at 120V (120-277V available).
This fixture is built to last with maintenance-free energy efficient LEDs.
Beam Angle: 30/60 Degree.
Suitable for damp locations.

APPLICATIONS

Apply to automotive and parking, education, government, healthcare, hospitality, offices and banks, religious, retail.

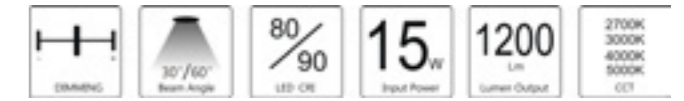

DIMENSIONS

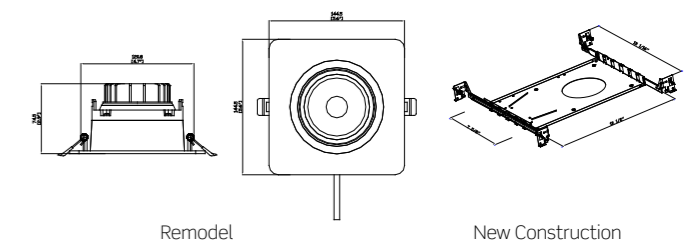

BEL4-A-S01-NC
New Construction

ORDERING GUIDE / YOUR PRODUCT CODE

SERIES	MOUNTING	INPUT VOLTAGE	Watt	CCT	DIMMABLE	FINISH
<input type="radio"/> BEL4-A-S01 LED Eyeball Downlight	<input type="radio"/> Remodel <input type="radio"/> New Construction	<input type="radio"/> 120V <input type="radio"/> 120-277V	<input type="radio"/> 15W	<input type="radio"/> 2700K <input type="radio"/> 3000K <input type="radio"/> 4000K <input type="radio"/> 5000K	<input type="radio"/> Non-Dimmable <input type="radio"/> Dimmable	<input type="radio"/> White <input type="radio"/> Black

* Customized Also Available

LISTING / WARRANTY

ETL listed to US and Canadian standards for damp location W/Feed through.
3 Years Limited Warranty.

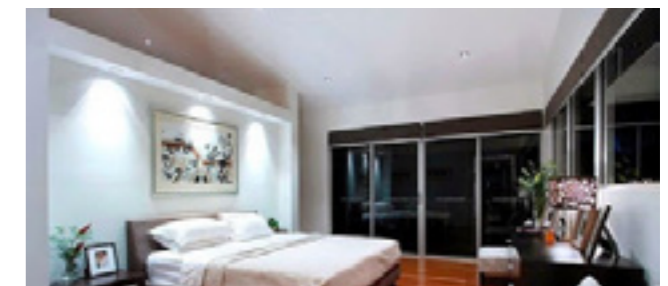

4 INCH ROUND SHAPE LED EYEBALL DOWNLIGHT

LIGHT SOURCE
COB LED **BEL4-A-02**



BEL4-A-02 | Remodel

DESCRIPTION

This is a 4" rotatable LED eyeball downlight allow for you to set the ambiance in your space, a full range of repositioning to highlight your decoration, giving you everything needed to install this beautiful, ultra thin recessed lighting solution.

FEATURES

Swivel eyeball trim allows the flexibility focus light on a specific area and create the ambiance you desire.

Dimming: TRAC Dimming, (0-10V dimming for 120-277V).

Protected LED driver performs at 120V (120-277V available).

This fixture is built to last with maintenance-free energy efficient LEDs.

Beam Angle: 30/60 Degree.

Suitable for damp locations.

APPLICATIONS

Apply to automotive and parking, education, government, healthcare, hospitality, offices and banks, religious, retail.

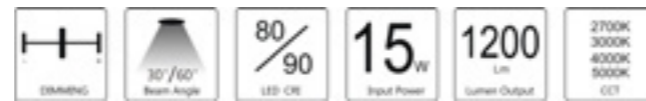

DIMENSIONS

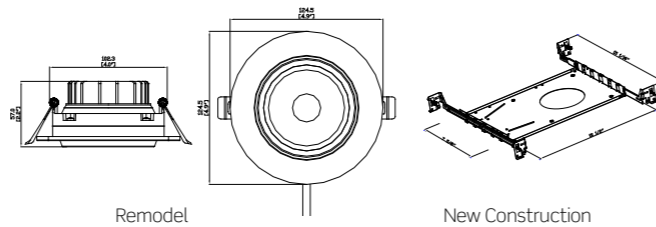

BEL4-A-02-NC
New Construction

ORDERING GUIDE / YOUR PRODUCT CODE

SERIES	MOUNTING	INPUT VOLTAGE	Watt	CCT	DIMMABLE	FINISH
<input type="radio"/> BEL4-A-02 LED Eyeball Downlight	<input type="radio"/> Remodel <input type="radio"/> New Construction	<input type="radio"/> 120V <input type="radio"/> 120-277V	<input type="radio"/> 15W	<input type="radio"/> 2700K <input type="radio"/> 3000K <input type="radio"/> 4000K <input type="radio"/> 5000K	<input type="radio"/> Non-Dimmable <input type="radio"/> Dimmable	<input type="radio"/> White <input type="radio"/> Black

* Customized Also Available

LISTING / WARRANTY

ETL listed to US and Canadian standards for damp location W/Feed through.
3 Years Limited Warranty.



4 INCH SQUARE SHAPE LED EYEBALL DOWNLIGHT

LIGHT SOURCE
COB LED **BEL4-A-S02**



BEL4-A-S02 | Remodel

DESCRIPTION

This is a 4" rotatable LED eyeball downlight allow for you to set the ambiance in your space, a full range of repositioning to highlight your decoration, giving you everything needed to install this beautiful, ultra thin recessed lighting solution.

FEATURES

Swivel eyeball trim allows the flexibility focus light on a specific area and create the ambiance you desire.

Dimming: TRAC Dimming, (0-10V dimming for 120-277V).

Protected LED driver performs at 120V (120-277V available).

This fixture is built to last with maintenance-free energy efficient LEDs.

Beam Angle: 30/60 Degree.

Suitable for damp locations.

APPLICATIONS

Apply to automotive and parking, education, government, healthcare, hospitality, offices and banks, religious, retail.



DIMENSIONS

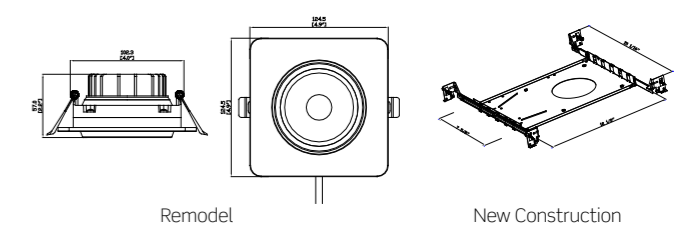

BEL4-A-S02-NC
New Construction

ORDERING GUIDE / YOUR PRODUCT CODE

SERIES	MOUNTING	INPUT VOLTAGE	Watt	CCT	DIMMABLE	FINISH
<input type="radio"/> BEL4-A-S02 LED Eyeball Downlight	<input type="radio"/> Remodel <input type="radio"/> New Construction	<input type="radio"/> 120V <input type="radio"/> 120-277V	<input type="radio"/> 15W	<input type="radio"/> 2700K <input type="radio"/> 3000K <input type="radio"/> 4000K <input type="radio"/> 5000K	<input type="radio"/> Non-Dimmable <input type="radio"/> Dimmable	<input type="radio"/> White <input type="radio"/> Black

* Customized Also Available

LISTING / WARRANTY

ETL listed to US and Canadian standards for damp location W/Feed through.
3 Years Limited Warranty.



4 INCH ROUND SHAPE LED EYEBALL MULTIPLE DOWNLIGHT

BEL401X-A Series
**DESCRIPTION**

This is a 4" rotatable LED eyeball multiple downlight allow for you to set the ambiance in your space, a full range of repositioning to highlight your decoration, giving you everything needed to install this beautiful, ultra thin recessed lighting solution.

FEATURES

Swivel eyball trim allows the flexibility focus light on a specific area and create the ambiance you desire.
 Dimming: TRAIAC Dimming, (0-10V dimming for 120-277V).
 Protected LED driver performs at 120V/120-277V.
 This fixture is built to last with maintenance-free energy efficient LEDs.
 Available in 1, 2, 3, 4 lamps.
 Beam Angle: 30/60 Degree.
 Suitable for damp location.

APPLICATIONS

Apply to automotive and parking, education, government, healthcare, hospitality, offices and banks, religious, retail.

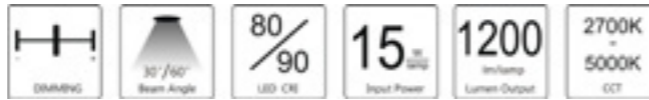
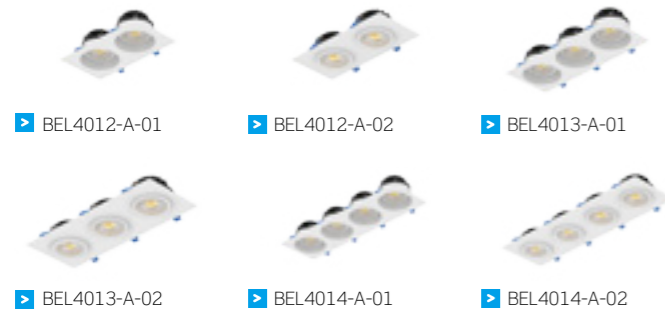
**LISTING / WARRANTY**

ETL listed to US and Canadian standards for damp location W/Feed through.
 3 Years Limited Warranty.

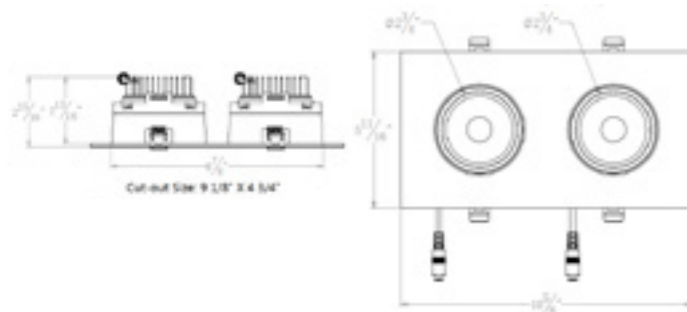
**DIMENSIONS**

BEL4012-A-01
 L: 10 5/8"xW: 5 11/16"xH: 2 15/16"
 Cut-Out: 9 1/8" x 4 3/4"

BEL4012-A-02
 L: 10 5/8"xW: 4 15/16"xH: 2 3/8"
 Cut-Out: 9" x 4"

BEL4013-A-01
 L: 14 9/16"xW: 5 11/16"xH: 2 15/16"
 Cut-Out: 13 7/8" x 4 3/4"

BEL4013-A-02
 L: 14 9/16"xW: 4 15/16"xH: 2 1/4"
 Cut-Out: 13 3/4" x 4"

BEL4014-A-01
 L: 19 3/8"xW: 5 11/16"xH: 2 15/16"
 Cut-Out: 18 3/4" x 4 3/4"

BEL4014-A-02
 L: 19 3/8"xW: 4 15/16"xH: 2 1/4"
 Cut-Out: 18 5/8" x 4"

ORDERING GUIDE / YOUR PRODUCT CODE

SERIES	VOLTAGE	WATT	CCT	FINISH	CRI	BEAM ANGLE	DIMMING
<input type="radio"/> BEL4012-A-01	<input type="radio"/> 120V	<input type="radio"/> 15W/lamp	<input type="radio"/> 2700K	<input type="radio"/> Black	<input type="radio"/> 80+	<input type="radio"/> 30°	<input type="radio"/> Non-dimming
<input type="radio"/> BEL4012-A-02	<input type="radio"/> 120~277V		<input type="radio"/> 3000K	<input type="radio"/> White	<input type="radio"/> 90+	<input type="radio"/> 60°	<input type="radio"/> TRAIAC Dimming
<input type="radio"/> BEL4013-A-01			<input type="radio"/> 4000K				<input type="radio"/> 0~10V Dimming
<input type="radio"/> BEL4013-A-02			<input type="radio"/> 5000K				
<input type="radio"/> BEL4014-A-01							
<input type="radio"/> BEL4014-A-02							
4" LED Eyeball Multiple Downlight							

* Customized Also Available

4 INCH SQUARE SHAPE LED EYEBALL MULTIPLE DOWNLIGHT

BEL401X-A-S Series
**DESCRIPTION**

This is a 4" rotatable LED eyeball multiple downlight allow for you to set the ambiance in your space, a full range of repositioning to highlight your decoration, giving you everything needed to install this beautiful, ultra thin recessed lighting solution.

FEATURES

Swivel eyball trim allows the flexibility focus light on a specific area and create the ambiance you desire.
 Dimming: TRAIAC Dimming, (0-10V dimming for 120-277V).
 Protected LED driver performs at 120V/120-277V.
 This fixture is built to last with maintenance-free energy efficient LEDs.
 Available in 1, 2, 3, 4 lamps.
 Beam Angle: 30/60 Degree.
 Suitable for damp location.

APPLICATIONS

Apply to automotive and parking, education, government, healthcare, hospitality, offices and banks, religious, retail.

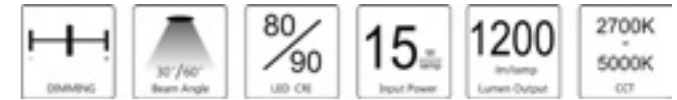
**LISTING / WARRANTY**

ETL listed to US and Canadian standards for damp location W/Feed through.
 3 Years Limited Warranty.

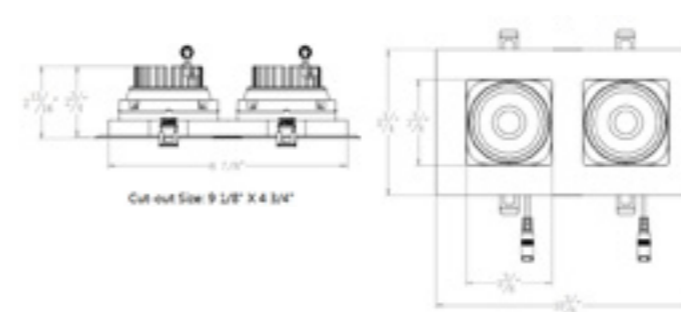
**DIMENSIONS**

BEL4012-A-S01
 L: 10 3/8"xW: 5 3/4"xH: 2 13/16"
 Cut-Out: 9 1/8" x 4 3/4"

BEL4013-A-S01
 L: 14 15/16"xW: 5 3/4"xH: 2 13/16"
 Cut-Out: 13 7/8" x 4 3/4"

BEL4014-A-S01
 L: 19 9/16"xW: 5 3/4"xH: 2 13/16"
 Cut-Out: 18 3/4" x 4 3/4"

ORDERING GUIDE / YOUR PRODUCT CODE

SERIES	VOLTAGE	WATT	CCT	FINISH	CRI	BEAM ANGLE	DIMMING
<input type="radio"/> BEL4012-A-S01	<input type="radio"/> 120V	<input type="radio"/> 15W/lamp	<input type="radio"/> 2700K	<input type="radio"/> Black	<input type="radio"/> 80+	<input type="radio"/> 30°	<input type="radio"/> Non-dimming
<input type="radio"/> BEL4013-A-S01	<input type="radio"/> 120~277V		<input type="radio"/> 3000K	<input type="radio"/> White	<input type="radio"/> 90+	<input type="radio"/> 60°	<input type="radio"/> TRAIAC Dimming
<input type="radio"/> BEL4014-A-S01			<input type="radio"/> 4000K				<input type="radio"/> 0~10V Dimming
4" LED Eyeball Multiple Downlight							

* Customized Also Available



LED RECESSED DOWNLIGHT

High efficiency SMD LED recessed panel light with selectable tri colour temperature and a powder coated white finish frame, providing you with high quality lighting every time you need.

2 INCH ROUND SHAPE LED DOWNLIGHT

LIGHT SOURCE SMD CHIPS **BL2-A-01**

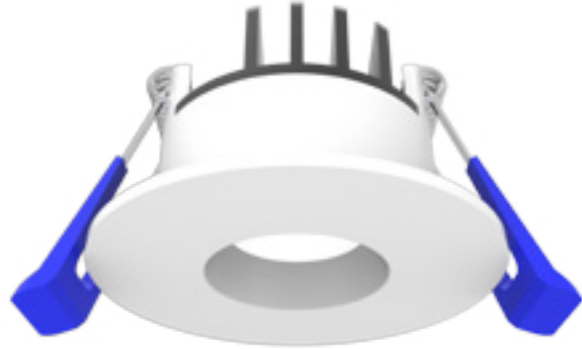

BL2-A-01 | Remodel

DESCRIPTION

This product is a high efficiency SMD LED downlight with selectable tri colour temperature and a powder coated white finish frame. It can be easily install in different types of ceiling without having to undergo messy and complicated routing and housing reconstruction while providing you with high quality lighting every time you need.

FEATURES

Full luminaire made of high quality die cast aluminium.
Protected LED driver performs at 120V.
This fixture is built to last with maintenance-free energy efficient LEDs.
Beam Angle: 90 Degree.
Suitable for damp locations.

APPLICATIONS

Apply to automotive and parking, education, government, healthcare, hospitality, offices and banks, religious, retail.

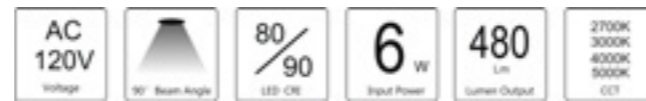

DIMENSIONS

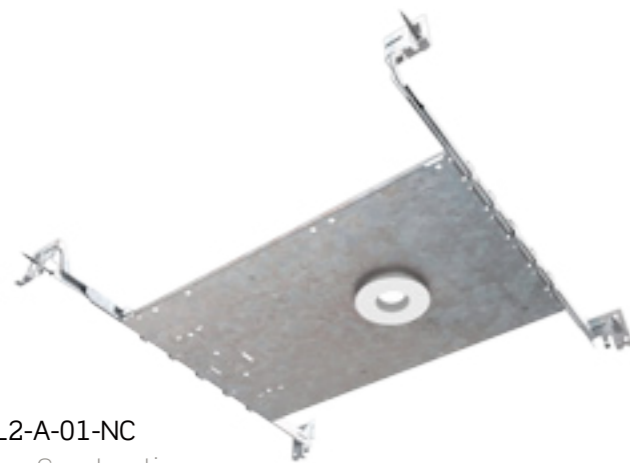

BL2-A-01-NC
New Construction

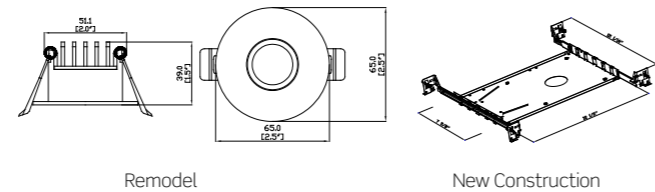

ORDERING GUIDE / YOUR PRODUCT CODE

SERIES	MOUNTING	INPUT VOLTAGE	Watt	CCT	DIMMABLE	FINISH
○ BL2-A-01 LED Eyeball Downlight	○ Remodel ○ New Construction	○ 120V	○ 6W	○ 2700K ○ 3000K ○ 4000K ○ 5000K	○ Non-Dimmable ○ Dimmable	○ White ○ Black

* Customized Also Available

LISTING / WARRANTY

ETL listed to US and Canadian standards for damp location W/Feed through.
3 Years Limited Warranty.



2 INCH SQUARE SHAPE LED DOWNLIGHT

LIGHT SOURCE SMD CHIPS **BL2-A-S01**



BL2-A-S01 | Remodel

DESCRIPTION

This product is a high efficiency SMD LED downlight with selectable tri colour temperature and a powder coated white finish frame. It can be easily install in different types of ceiling without having to undergo messy and complicated routing and housing reconstruction while providing you with high quality lighting every time you need.

FEATURES

Full luminaire made of high quality die cast aluminium.
Protected LED driver performs at 120V.
This fixture is built to last with maintenance-free energy efficient LEDs.
Beam Angle: 90 Degree.
Suitable for damp locations.

APPLICATIONS

Apply to automotive and parking, education, government, healthcare, hospitality, offices and banks, religious, retail.



DIMENSIONS



BL2-A-S01-NC
New Construction

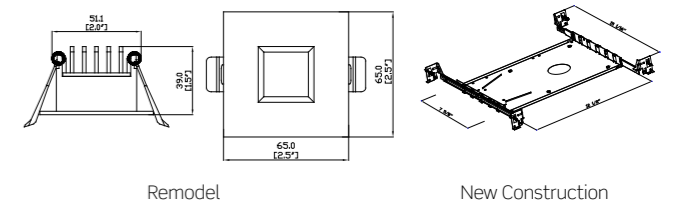

ORDERING GUIDE / YOUR PRODUCT CODE

SERIES	MOUNTING	INPUT VOLTAGE	Watt	CCT	DIMMABLE	FINISH
○ BL2-A-S01 LED Eyeball Downlight	○ Remodel ○ New Construction	○ 120V	○ 6W	○ 2700K ○ 3000K ○ 4000K ○ 5000K	○ Non-Dimmable ○ Dimmable	○ White ○ Black

* Customized Also Available

LISTING / WARRANTY

ETL listed to US and Canadian standards for damp location W/Feed through.
3 Years Limited Warranty.



3 INCH ROUND SHAPE LED DOWNLIGHT

LIGHT SOURCE SMD CHIPS **BL3-A-01**



DESCRIPTION

This product is a high efficiency SMD LED downlight with selectable tri colour temperature and a powder coated white finish frame. It can be easily install in different types of ceiling without having to undergo messy and complicated routing and housing reconstruction while providing you with high quality lighting every time you need.

FEATURES

Full luminaire made of high quality die cast aluminium.
Protected LED driver performs at 120V.
This fixture is built to last with maintenance-free energy efficient LEDs.
Beam Angle: 90 Degree.
Suitable for damp locations.

APPLICATIONS

Apply to automotive and parking, education, government, healthcare, hospitality, offices and banks, religious, retail.

BL3-A-01 | Remodel



DIMENSIONS

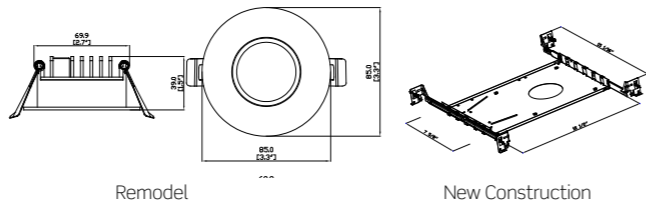

BL3-A-01-NC
New Construction

ORDERING GUIDE / YOUR PRODUCT CODE

SERIES	MOUNTING	INPUT VOLTAGE	Watt	CCT	DIMMABLE	FINISH
<input type="radio"/> BL3-A-01 LED Eyeball Downlight	<input type="radio"/> Remodel <input type="radio"/> New Construction	<input type="radio"/> 120V	<input type="radio"/> 10W	<input type="radio"/> 2700K <input type="radio"/> 3000K <input type="radio"/> 4000K <input type="radio"/> 5000K	<input type="radio"/> Non-Dimmable <input type="radio"/> Dimmable	<input type="radio"/> White <input type="radio"/> Black

* Customized Also Available

LISTING / WARRANTY

ETL listed to US and Canadian standards for damp location W/Feed through.
3 Years Limited Warranty.



3 INCH SQUARE SHAPE LED DOWNLIGHT

LIGHT SOURCE SMD CHIPS **BL3-A-S01**



DESCRIPTION

This product is a high efficiency SMD LED downlight with selectable tri colour temperature and a powder coated white finish frame. It can be easily install in different types of ceiling without having to undergo messy and complicated routing and housing reconstruction while providing you with high quality lighting every time you need.

FEATURES

Full luminaire made of high quality die cast aluminium.
Protected LED driver performs at 120V.
This fixture is built to last with maintenance-free energy efficient LEDs.
Beam Angle: 90 Degree.
Suitable for damp locations.

APPLICATIONS

Apply to automotive and parking, education, government, healthcare, hospitality, offices and banks, religious, retail.

BL3-A-S01 | Remodel



DIMENSIONS

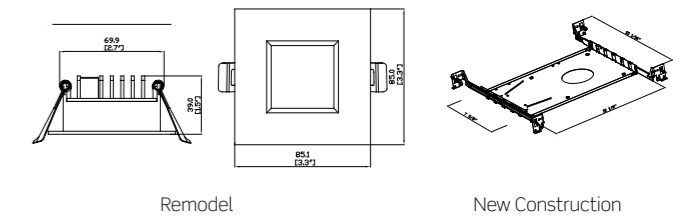

BL3-A-S01-NC
New Construction

ORDERING GUIDE / YOUR PRODUCT CODE

SERIES	MOUNTING	INPUT VOLTAGE	Watt	CCT	DIMMABLE	FINISH
<input type="radio"/> BL3-A-S01 LED Eyeball Downlight	<input type="radio"/> Remodel <input type="radio"/> New Construction	<input type="radio"/> 120V	<input type="radio"/> 10W	<input type="radio"/> 2700K <input type="radio"/> 3000K <input type="radio"/> 4000K <input type="radio"/> 5000K	<input type="radio"/> Non-Dimmable <input type="radio"/> Dimmable	<input type="radio"/> White <input type="radio"/> Black

* Customized Also Available

LISTING / WARRANTY

ETL listed to US and Canadian standards for damp location W/Feed through.
3 Years Limited Warranty.



4 INCH ROUND SHAPE LED DOWNLIGHT

BL4-A-01



DESCRIPTION

This product is a high efficiency SMD LED downlight with selectable tri colour temperature and a powder coated white finish frame. It can be easily install in different types of ceiling without having to undergo messy and complicated routing and housing reconstruction while providing you with high quality lighting every time you need.

FEATURES

Full luminaire made of high quality die cast aluminium.
Protected LED driver performs at 120V.
This fixture is built to last with maintenance-free energy efficient LEDs.
Beam Angle: 90 Degree.
Suitable for damp locations.

APPLICATIONS

Apply to automotive and parking, education, government, healthcare, hospitality, offices and banks, religious, retail.

BL4-A-01 | Remodel

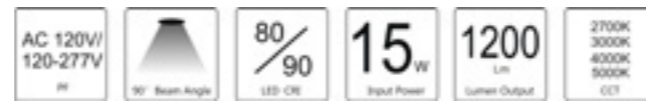

DIMENSIONS

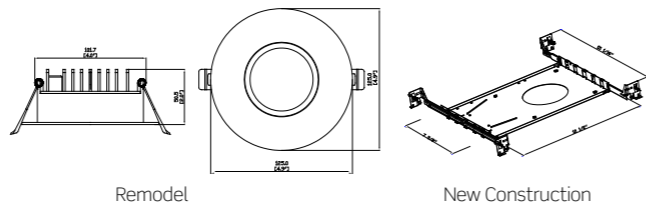

BL4-A-01-NC
New Construction

ORDERING GUIDE / YOUR PRODUCT CODE

SERIES	MOUNTING	INPUT VOLTAGE	Watt	CCT	DIMMABLE	FINISH
<input type="radio"/> BL4-A-01 LED Eyeball Downlight	<input type="radio"/> Remodel <input type="radio"/> New Construction	<input type="radio"/> 120V <input type="radio"/> 120-277V	<input type="radio"/> 15W	<input type="radio"/> 2700K <input type="radio"/> 3000K <input type="radio"/> 4000K <input type="radio"/> 5000K	<input type="radio"/> Non-Dimmable <input type="radio"/> Dimmable	<input type="radio"/> White <input type="radio"/> Black

* Customized Also Available

LISTING / WARRANTY

ETL listed to US and Canadian standards for damp location W/Feed through.
3 Years Limited Warranty.



4 INCH SQUARE SHAPE LED DOWNLIGHT

BL4-A-S01



DESCRIPTION

This product is a high efficiency SMD LED downlight with selectable tri colour temperature and a powder coated white finish frame. It can be easily install in different types of ceiling without having to undergo messy and complicated routing and housing reconstruction while providing you with high quality lighting every time you need.

FEATURES

Full luminaire made of high quality die cast aluminium.
Protected LED driver performs at 120V.
This fixture is built to last with maintenance-free energy efficient LEDs.
Beam Angle: 90 Degree.
Suitable for damp locations.

APPLICATIONS

Apply to automotive and parking, education, government, healthcare, hospitality, offices and banks, religious, retail.

BL4-A-S01 | Remodel



DIMENSIONS

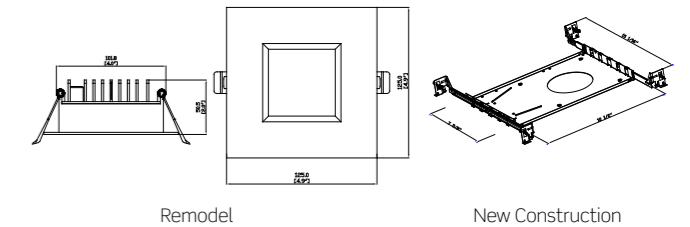

BL4-A-S01-NC
New Construction

ORDERING GUIDE / YOUR PRODUCT CODE

SERIES	MOUNTING	INPUT VOLTAGE	Watt	CCT	DIMMABLE	FINISH
<input type="radio"/> BL4-A-S01 LED Eyeball Downlight	<input type="radio"/> Remodel <input type="radio"/> New Construction	<input type="radio"/> 120V <input type="radio"/> 120-277V	<input type="radio"/> 15W	<input type="radio"/> 2700K <input type="radio"/> 3000K <input type="radio"/> 4000K <input type="radio"/> 5000K	<input type="radio"/> Non-Dimmable <input type="radio"/> Dimmable	<input type="radio"/> White <input type="radio"/> Black

* Customized Also Available

LISTING / WARRANTY

ETL listed to US and Canadian standards for damp location W/Feed through.
3 Years Limited Warranty.

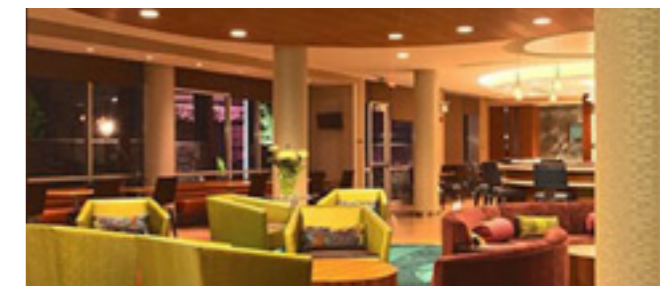



MINIATURE LED RECESSED DOWNLIGHT

Liteharbor Lighting Miniature LED Recessed Downlight Series is a new design for LED Downlight. The 1 & 2 inch light emitting surface achieves the most extreme mini size and it's perfect for the residential lighting.

MINIATURE LED RECESSED DOWNLIGHT



Installation



Remodel



New Construction with Mounting Plate

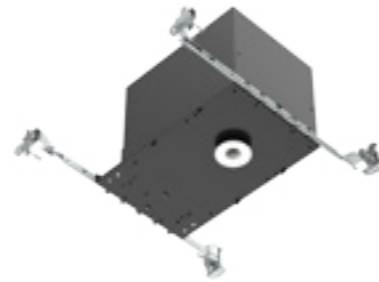

New Construction with IC Airtight Housing

Why We Need The Miniature LED Downlight?

- Mini light emitting surface, only 1 & 2 inch
- IC Airtight for use with direct contact to insulation
- Remodel requires no frame
- Easy installation for new construction and remodel applications
- More suitable for residential lighting



Remodel 1 Inch Round Downlight



1 Inch Square Downlight



2 Inch Round Gimbal Downlight



2 Inch Square Pull Down Downlight

Structure Elucidation

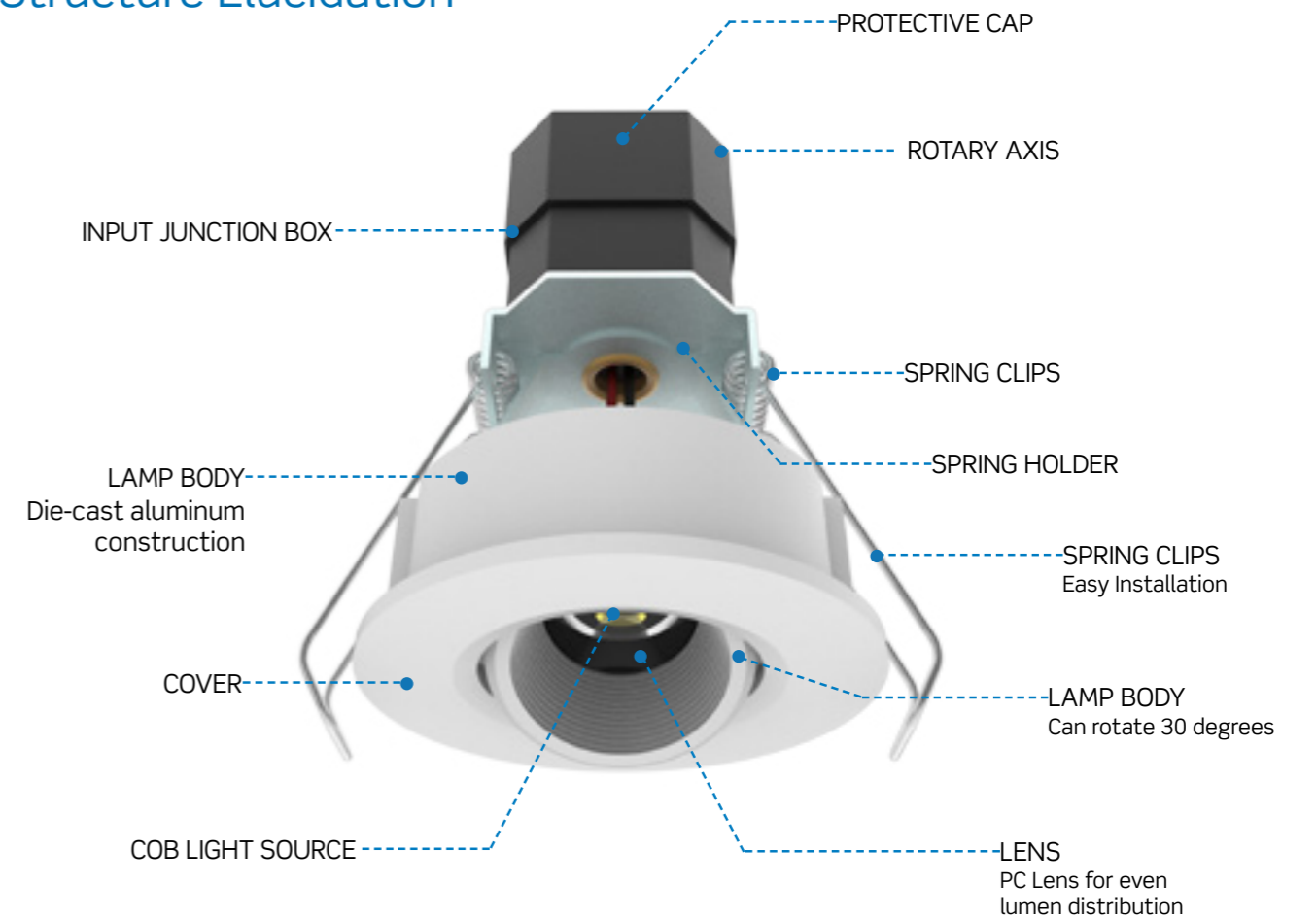

Trim Option

Option ① : Color

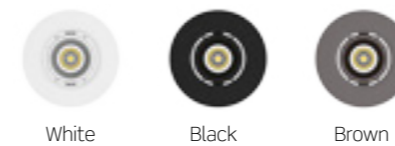

White Black Brown

Option ② : Smooth Trim



OPTION ③ : BAFFLE TRIM



ROUND SHAPE MINIATURE LED RECESSED DOWNLIGHT

BL1-001



BL1-001 | Remodel



BL1-001-NC
New Construction

COVER COLOR OPTION

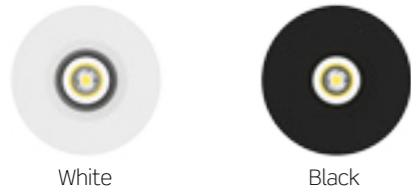

White

Black

FEATURES

1 inch light-emitting surface.
The simplified retrofit installation can be used in both new and existing spaces.
IC Airtight for use with direct contact to insulation.
Beam Angle: 30/60 Degrees.
Life Rated for 50,000 hours at 70% lumen maintenance.
Easy installation for new construction and remodel applications.

SPECIFICATION

Source: LED COB Chips.
Lumen maintenance: 50,000 hours L70 based on LM80 standardized test results.
Optics: PC Lens for even lumen distribution.
Material: Die-cast aluminum construction for lasting quality.
Mounting: New construction installation or remodel installation
Electrical: High efficiency electronic driver.
Heat dissipation: Superior Thermal Management by utilizing aluminum body as heat sink.

SPECIFICATION

Suitable for jewelry stores, boutiques, luxury goods stores, shopping malls and other places that require concentrated lighting and accent lighting.



DIMENSIONS

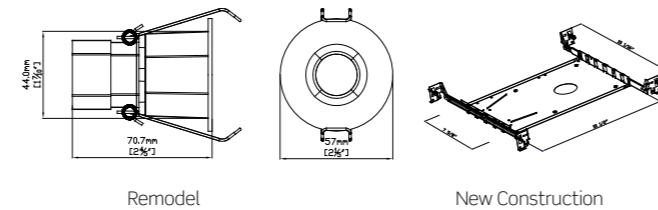

ORDERING GUIDE / YOUR PRODUCT CODE

SERIES	MOUNTING	INPUT VOLTAGE	Watt	CCT	CRI	TRIM	DIMMABLE	FINISH
<input type="radio"/> BL1-001 LED Downlight	<input type="radio"/> Remodel <input type="radio"/> New Construction	<input type="radio"/> AC/DC 12V	<input type="radio"/> 8W	<input type="radio"/> 3000K <input type="radio"/> 4000K <input type="radio"/> 5000K	<input type="radio"/> 80+ <input type="radio"/> 90+	<input type="radio"/> Smooth Trim <input type="radio"/> Baffle Trim	<input type="radio"/> Non-Dimmable <input type="radio"/> Dimmable	<input type="radio"/> White <input type="radio"/> Black <input type="radio"/> Brown

* Other special requirements please confirm with our factory

LISTING / WARRANTY

ETL listed to US and Canadian standards for damp location W/Feed through.
3 Years Limited Warranty.



SQUARE SHAPE MINIATURE LED RECESSED DOWNLIGHT

BL1-S001



BL1-S001 | Remodel



BL1-S001-NC
New Construction

COVER COLOR OPTION

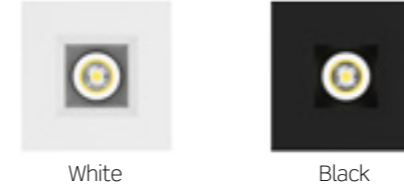

White

Black

FEATURES

1 inch light-emitting surface.
The simplified retrofit installation can be used in both new and existing spaces.
IC Airtight for use with direct contact to insulation.
Beam Angle: 30/60 Degrees.
Life Rated for 50,000 hours at 70% lumen maintenance.
Easy installation for new construction and remodel applications.

SPECIFICATION

Source: LED COB Chips.
Lumen maintenance: 50,000 hours L70 based on LM80 standardized test results.
Optics: PC Lens for even lumen distribution.
Material: Die-cast aluminum construction for lasting quality.
Mounting: New construction installation or remodel installation
Electrical: High efficiency electronic driver.
Heat dissipation: Superior Thermal Management by utilizing aluminum body as heat sink.

SPECIFICATION

Suitable for jewelry stores, boutiques, luxury goods stores, shopping malls and other places that require concentrated lighting and accent lighting.



DIMENSIONS

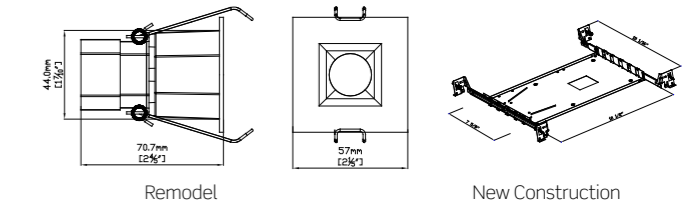

ORDERING GUIDE / YOUR PRODUCT CODE

SERIES	MOUNTING	INPUT VOLTAGE	Watt	CCT	CRI	TRIM	DIMMABLE	FINISH
<input type="radio"/> BL1-S001 LED Downlight	<input type="radio"/> Remodel <input type="radio"/> New Construction	<input type="radio"/> AC/DC 12V	<input type="radio"/> 8W	<input type="radio"/> 3000K <input type="radio"/> 4000K <input type="radio"/> 5000K	<input type="radio"/> 80+ <input type="radio"/> 90+	<input type="radio"/> Smooth Trim <input type="radio"/> Baffle Trim	<input type="radio"/> Non-Dimmable <input type="radio"/> Dimmable	<input type="radio"/> White <input type="radio"/> Black <input type="radio"/> Brown

* Other special requirements please confirm with our factory

LISTING / WARRANTY

ETL listed to US and Canadian standards for damp location W/Feed through.
3 Years Limited Warranty.

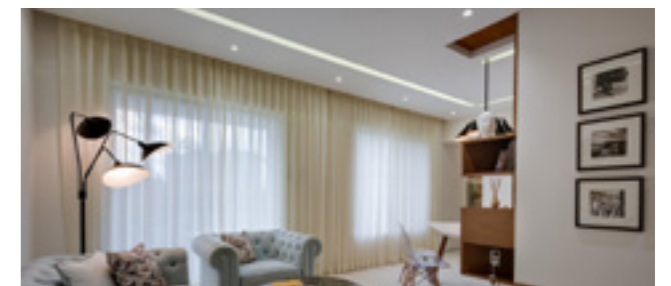

ROUND SHAPE MINIATURE LED RECESSED DOWNLIGHT

LIGHT SOURCE
COB LED **BL2-001**



BL2-001 | Remodel



BL2-001-NC
New Construction

COVER COLOR OPTION

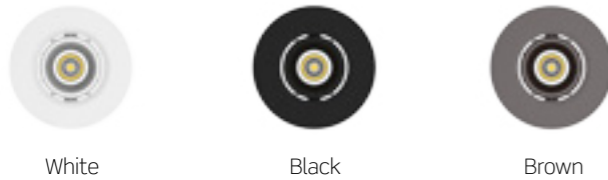

FEATURES

2 inch light-emitting surface.
The simplified retrofit installation can be used in both new and existing spaces.
IC Airtight for use with direct contact to insulation.
Beam Angle: 30/60 Degrees.
Life Rated for 50,000 hours at 70% lumen maintenance.
Easy installation for new construction and remodel applications.

SPECIFICATION

Source: LED COB Chips.
Lumen maintenance: 50,000 hours L70 based on LM80 standardized test results.
Optics: PC Lens for even lumen distribution.
Material: Die-cast aluminum construction for lasting quality.
Mounting: New construction installation or remodel installation
Electrical: High efficiency electronic driver.
Heat dissipation: Superior Thermal Management by utilizing aluminum body as heat sink.

SPECIFICATION

Suitable for jewelry stores, boutiques, luxury goods stores, shopping malls and other places that require concentrated lighting and accent lighting.



DIMENSIONS

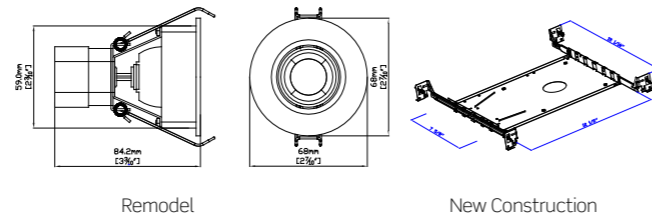

ORDERING GUIDE / YOUR PRODUCT CODE

SERIES	MOUNTING	INPUT VOLTAGE	Watt	CCT	CRI	TRIM	DIMMABLE	FINISH
<input type="radio"/> BL2-001 LED Downlight	<input type="radio"/> Remodel <input type="radio"/> New Construction	<input type="radio"/> AC/DC 12V	<input type="radio"/> 8W	<input type="radio"/> 3000K <input type="radio"/> 4000K <input type="radio"/> 5000K	<input type="radio"/> 80+ <input type="radio"/> 90+	<input type="radio"/> Smooth Trim <input type="radio"/> Baffle Trim	<input type="radio"/> Non-Dimmable <input type="radio"/> Dimmable	<input type="radio"/> White <input type="radio"/> Black <input type="radio"/> Brown

* Other special requirements please confirm with our factory

LISTING / WARRANTY

ETL listed to US and Canadian standards for damp location W/Feed through.
3 Years Limited Warranty.

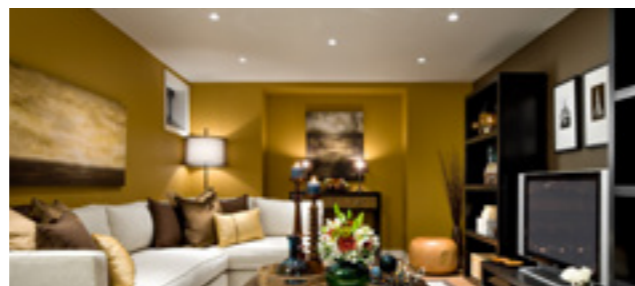

SQUARE SHAPE MINIATURE LED RECESSED DOWNLIGHT

LIGHT SOURCE
COB LED **BL2-S001**

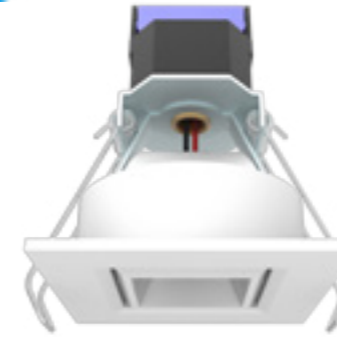

BL2-S001 | Remodel



BL2-S001-NC
New Construction

COVER COLOR OPTION

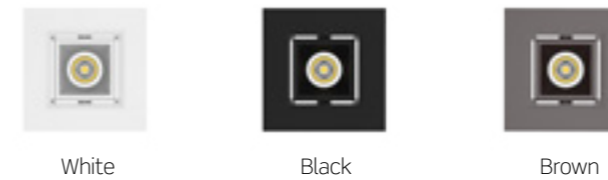

FEATURES

2 inch light-emitting surface.
The simplified retrofit installation can be used in both new and existing spaces.
IC Airtight for use with direct contact to insulation.
Beam Angle: 30/60 Degrees.
Life Rated for 50,000 hours at 70% lumen maintenance.
Easy installation for new construction and remodel applications.

SPECIFICATION

Source: LED COB Chips.
Lumen maintenance: 50,000 hours L70 based on LM80 standardized test results.
Optics: PC Lens for even lumen distribution.
Material: Die-cast aluminum construction for lasting quality.
Mounting: New construction installation or remodel installation
Electrical: High efficiency electronic driver.
Heat dissipation: Superior Thermal Management by utilizing aluminum body as heat sink.

SPECIFICATION

Suitable for jewelry stores, boutiques, luxury goods stores, shopping malls and other places that require concentrated lighting and accent lighting.



DIMENSIONS

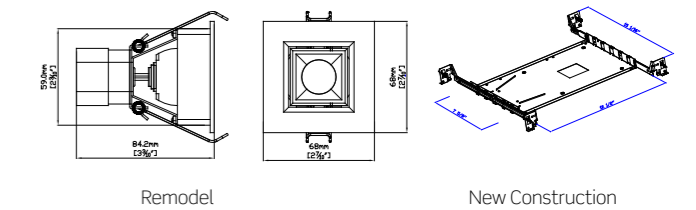

ORDERING GUIDE / YOUR PRODUCT CODE

SERIES	MOUNTING	INPUT VOLTAGE	Watt	CCT	CRI	TRIM	DIMMABLE	FINISH
<input type="radio"/> BL2-S001 LED Downlight	<input type="radio"/> Remodel <input type="radio"/> New Construction	<input type="radio"/> AC/DC 12V	<input type="radio"/> 8W	<input type="radio"/> 3000K <input type="radio"/> 4000K <input type="radio"/> 5000K	<input type="radio"/> 80+ <input type="radio"/> 90+	<input type="radio"/> Smooth Trim <input type="radio"/> Baffle Trim	<input type="radio"/> Non-Dimmable <input type="radio"/> Dimmable	<input type="radio"/> White <input type="radio"/> Black <input type="radio"/> Brown

* Other special requirements please confirm with our factory

LISTING / WARRANTY

ETL listed to US and Canadian standards for damp location W/Feed through.
3 Years Limited Warranty.



ROUND SHAPE IC AIRTIGHT NEW CONSTRUCTION MINIATURE LED RECESSED DOWNLIGHT

LIGHT SOURCE
COB LED **BL1-001-IA**

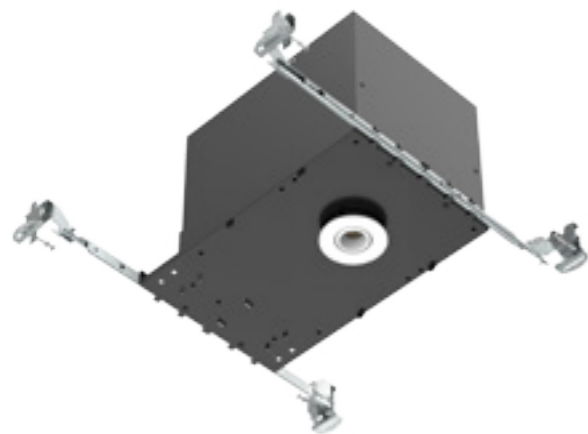

FEATURES

The simplified retrofit installation can be used in both new and existing spaces. IC Airtight for use with direct contact to insulation.
1 inch light-emitting surface.
Beam Angle: 30/60 Degrees.
Life Rated for 50,000 hours at 70% lumen maintenance.
Easy installation for new construction and remodel applications.

CONSTRUCTION

Double wall IC rated for direct contact with insulation. For use in IC and non-IC conditions.
Housing adjusts in frame to accommodate up to 1/2" ceiling thickness.
Airtight housing with gasket to restrict airflow in accordance with ASTM E-283 air-tight requirements.

INSTALLATION

Designed for ceiling plenums where 2x8 joists or taller are used.
High strength hanger bars can easily be nailed to joists.
Suitable for T-grid and drop ceiling applications.

SPECIFICATION

Source: LED COB Chips.
Lumen maintenance: 50,000 hours L70 based on LM80 standardized test results.
Optics: PC Lens for even lumen distribution.
Material: Die-cast aluminum construction for lasting quality.
Mounting: New construction installation or remodel installation
Electrical: High efficiency electronic driver.
Heat dissipation: Superior Thermal Management by utilizing aluminum body as heat sink.

APPLICATIONS

Suitable for jewelry stores, boutiques, luxury goods stores, shopping malls and other places that require concentrated lighting and accent lighting.

TRIM OPTIONS



Option 1: Smooth Trim



Option 2: Baffle Trim

DIMENSIONS

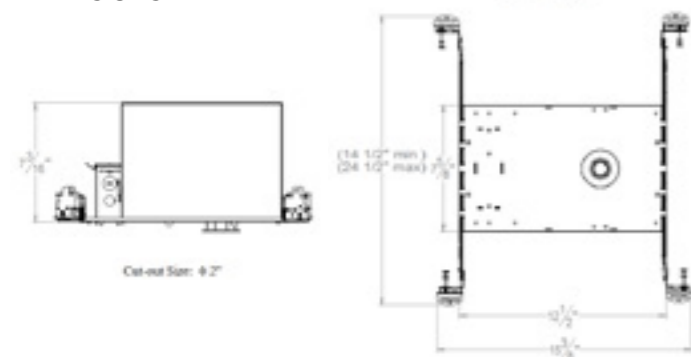

LISTING / WARRANTY

ETL listed to US and Canadian standards for damp location W/Feed through.
3 Years Limited Warranty.



ORDERING GUIDE / YOUR PRODUCT CODE

SERIES	INPUT VOLTAGE	CCT	CRI	BEAM ANGLE	DIMMABLE	TRIM	FINISH
<input type="radio"/> BL1-001-IA	<input type="radio"/> AC 12V	<input type="radio"/> 3000K	<input type="radio"/> 80+	<input type="radio"/> 30°	<input type="radio"/> Non-Dimmable	<input type="radio"/> Smooth Trim	<input type="radio"/> White
IC Airtight	<input type="radio"/> DC 12V	<input type="radio"/> 4000K	<input type="radio"/> 90+	<input type="radio"/> 60°	<input type="radio"/> Dimmable	<input type="radio"/> Baffle Trim	<input type="radio"/> Black
LED Downlight		<input type="radio"/> 5000K					<input type="radio"/> Brown

*Other special requirements please confirm with our factory

SQUARE SHAPE IC AIRTIGHT NEW CONSTRUCTION MINIATURE LED RECESSED DOWNLIGHT

LIGHT SOURCE
COB LED **BL1-S001-IA**

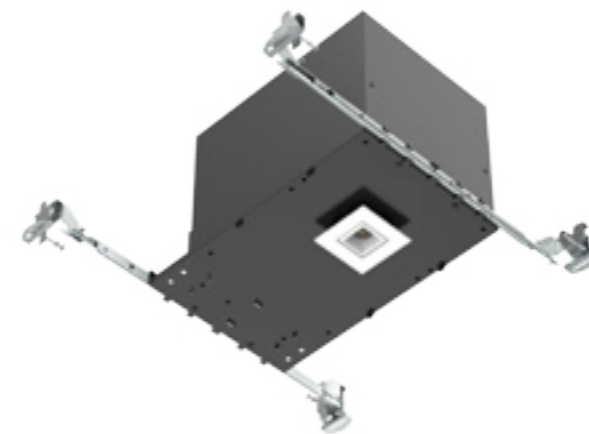

FEATURES

The simplified retrofit installation can be used in both new and existing spaces. IC Airtight for use with direct contact to insulation.
1 inch light-emitting surface.
Beam Angle: 30/60 Degrees.
Life Rated for 50,000 hours at 70% lumen maintenance.
Easy installation for new construction and remodel applications.

CONSTRUCTION

Double wall IC rated for direct contact with insulation. For use in IC and non-IC conditions.
Housing adjusts in frame to accommodate up to 1/2" ceiling thickness.
Airtight housing with gasket to restrict airflow in accordance with ASTM E-283 air-tight requirements.

INSTALLATION

Designed for ceiling plenums where 2x8 joists or taller are used.
High strength hanger bars can easily be nailed to joists.
Suitable for T-grid and drop ceiling applications.

TRIM OPTIONS



Option 1: Smooth Trim

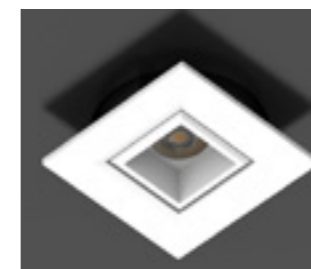

Option 2: Baffle Trim

DIMENSIONS

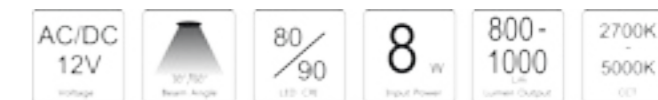
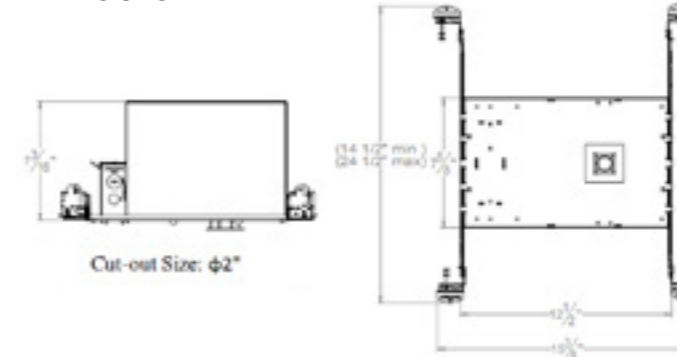

LISTING / WARRANTY

ETL listed to US and Canadian standards for damp location W/Feed through.
3 Years Limited Warranty.



ORDERING GUIDE / YOUR PRODUCT CODE

SERIES	INPUT VOLTAGE	CCT	CRI	BEAM ANGLE	DIMMABLE	TRIM	FINISH
<input type="radio"/> BL1-S001-IA	<input type="radio"/> AC 12V	<input type="radio"/> 3000K	<input type="radio"/> 80+	<input type="radio"/> 30°	<input type="radio"/> Non-Dimmable	<input type="radio"/> Smooth Trim	<input type="radio"/> White
IC Airtight	<input type="radio"/> DC 12V	<input type="radio"/> 4000K	<input type="radio"/> 90+	<input type="radio"/> 60°	<input type="radio"/> Dimmable	<input type="radio"/> Baffle Trim	<input type="radio"/> Black
LED Downlight		<input type="radio"/> 5000K					<input type="radio"/> Brown

*Other special requirements please confirm with our factory

ROUND SHAPE IC AIRTIGHT NEW CONSTRUCTION MINIATURE LED RECESSED DOWNLIGHT

LIGHT SOURCE
COB LED **BL2-001-IA**

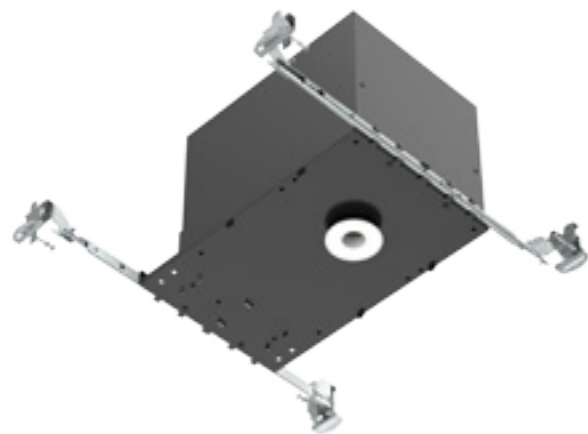

FEATURES

The simplified retrofit installation can be used in both new and existing spaces. IC Airtight for use with direct contact to insulation.
2 inch light-emitting surface.
Beam Angle: 30/60 Degrees.
Life Rated for 50,000 hours at 70% lumen maintenance.
Easy installation for new construction and remodel applications.

CONSTRUCTION

Double wall IC rated for direct contact with insulation. For use in IC and non-IC conditions.
Housing adjusts in frame to accommodate up to 1/2" ceiling thickness.
Airtight housing with gasket to restrict airflow in accordance with ASTM E-283 air-tight requirements.

INSTALLATION

Designed for ceiling plenums where 2x8 joists or taller are used.
High strength hanger bars can easily be nailed to joists.
Suitable for T-grid and drop ceiling applications.

SPECIFICATION

Source: LED COB Chips.
Lumen maintenance: 50,000 hours L70 based on LM80 standardized test results.
Optics: PC Lens for even lumen distribution.
Material: Die-cast aluminum construction for lasting quality.
Mounting: New construction installation or remodel installation
Electrical: High efficiency electronic driver.
Heat dissipation: Superior Thermal Management by utilizing aluminum body as heat sink.

APPLICATIONS

Suitable for jewelry stores, boutiques, luxury goods stores, shopping malls and other places that require concentrated lighting and accent lighting.



LISTING / WARRANTY

ETL listed to US and Canadian standards for damp location W/Feed through.
3 Years Limited Warranty.



TRIM OPTIONS



Option 1: Smooth Trim



Option 2: Baffle Trim

DIMENSIONS

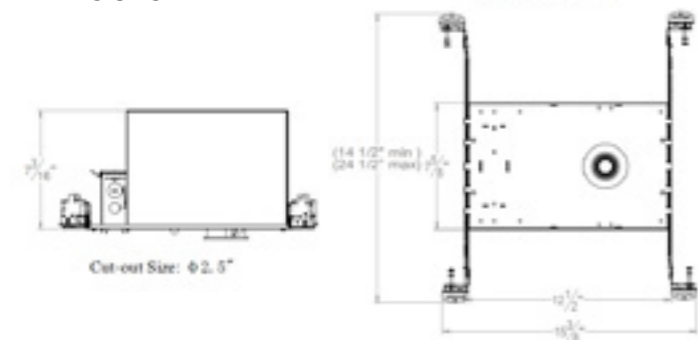

ORDERING GUIDE / YOUR PRODUCT CODE

SERIES	INPUT VOLTAGE	CCT	CRI	BEAM ANGLE	DIMMABLE	TRIM	FINISH
<input type="radio"/> BL2-001-IA	<input type="radio"/> AC 12V	<input type="radio"/> 3000K	<input type="radio"/> 80+	<input type="radio"/> 30°	<input type="radio"/> Non-Dimmable	<input type="radio"/> Smooth Trim	<input type="radio"/> White
IC Airtight	<input type="radio"/> DC 12V	<input type="radio"/> 4000K	<input type="radio"/> 90+	<input type="radio"/> 60°	<input type="radio"/> Dimmable	<input type="radio"/> Baffle Trim	<input type="radio"/> Black
LED Downlight		<input type="radio"/> 5000K					<input type="radio"/> Brown

*Other special requirements please confirm with our factory

SQUARE SHAPE IC AIRTIGHT NEW CONSTRUCTION MINIATURE LED RECESSED DOWNLIGHT

LIGHT SOURCE
COB LED **BL2-S001-IA**

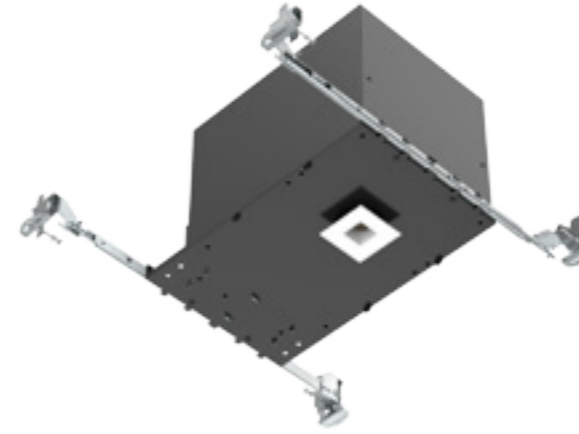

FEATURES

The simplified retrofit installation can be used in both new and existing spaces. IC Airtight for use with direct contact to insulation.
2 inch light-emitting surface.
Beam Angle: 30/60 Degrees.
Life Rated for 50,000 hours at 70% lumen maintenance.
Easy installation for new construction and remodel applications.

CONSTRUCTION

Double wall IC rated for direct contact with insulation. For use in IC and non-IC conditions.
Housing adjusts in frame to accommodate up to 1/2" ceiling thickness.
Airtight housing with gasket to restrict airflow in accordance with ASTM E-283 air-tight requirements.

INSTALLATION

Designed for ceiling plenums where 2x8 joists or taller are used.
High strength hanger bars can easily be nailed to joists.
Suitable for T-grid and drop ceiling applications.

SPECIFICATION

Source: LED COB Chips.
Lumen maintenance: 50,000 hours L70 based on LM80 standardized test results.
Optics: PC Lens for even lumen distribution.
Material: Die-cast aluminum construction for lasting quality.
Mounting: New construction installation or remodel installation
Electrical: High efficiency electronic driver.
Heat dissipation: Superior Thermal Management by utilizing aluminum body as heat sink.

APPLICATIONS

Suitable for jewelry stores, boutiques, luxury goods stores, shopping malls and other places that require concentrated lighting and accent lighting.



LISTING / WARRANTY

ETL listed to US and Canadian standards for damp location W/Feed through.
3 Years Limited Warranty.



TRIM OPTIONS



Option 1: Smooth Trim



Option 2: Baffle Trim

DIMENSIONS

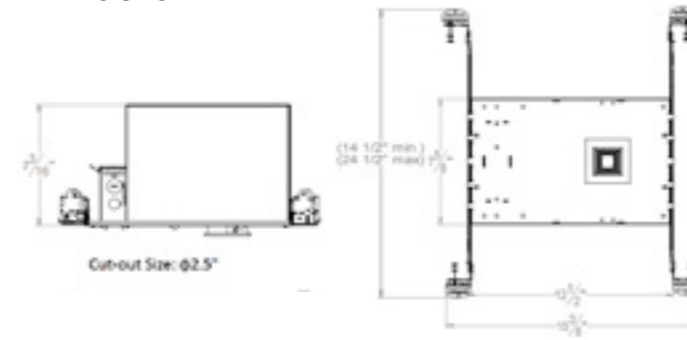

ORDERING GUIDE / YOUR PRODUCT CODE

SERIES	INPUT VOLTAGE	CCT	CRI	BEAM ANGLE	DIMMABLE	TRIM	FINISH
<input type="radio"/> BL2-S001-IA	<input type="radio"/> AC 12V	<input type="radio"/> 3000K	<input type="radio"/> 80+	<input type="radio"/> 30°	<input type="radio"/> Non-Dimmable	<input type="radio"/> Smooth Trim	<input type="radio"/> White
IC Airtight	<input type="radio"/> DC 12V	<input type="radio"/> 4000K	<input type="radio"/> 90+	<input type="radio"/> 60°	<input type="radio"/> Dimmable	<input type="radio"/> Baffle Trim	<input type="radio"/> Black
LED Downlight		<input type="radio"/> 5000K					<input type="radio"/> Brown

*Other special requirements please confirm with our factory

ROUND NEW CONSTRUCTION LED MULTIPLE DOWNLIGHT

LIGHT SOURCE COB LED G211X-P Series



FEATURES

The simplified retrofit installation can be used in both new and existing spaces.
 IC Airtight for use with direct contact to insulation.
 1 inch light-emitting surface.
 Available in 1, 2, 3, 4, 2x2 lamps.
 Beam Angle: 30/60 Degrees.
 Life Rated for 50,000 hours at 70% lumen maintenance.
 Easy installation for new construction and remodel applications.

SPECIFICATION

Source: LED COB Chips.
 Lumen maintenance: 50,000 hours L70 based on LM80 standardized test results.
 Optics: PC Lens for even lumen distribution.
 Material: Die-cast aluminum construction for lasting quality.
 Mounting: New construction installation or remodel installation
 Electrical: High efficiency electronic driver.
 Heat dissipation: Superior Thermal Management by utilizing aluminum body as heat sink.

APPLICATIONS

Suitable for jewelry stores, boutiques, luxury goods stores, shopping malls and other places that require concentrated lighting and accent lighting.

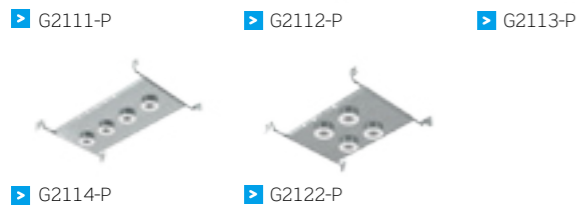
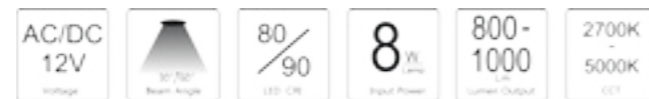

LISTING / WARRANTY

ETL listed to US and Canadian standards for damp location W/Feed through.
 3 Years Limited Warranty.



DIMENSIONS

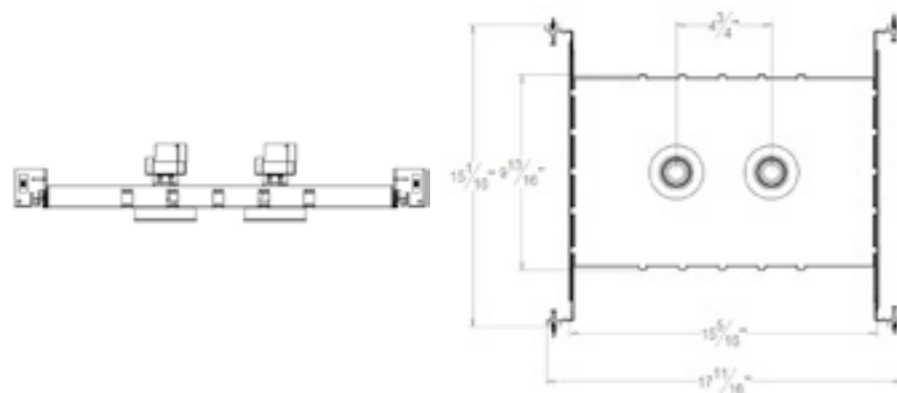

G2111-P
 L: 9 3/4"xW: 9 13/16"xH: 2 3/4"

G2112-P
 L: 15 5/16"xW: 9 13/16"xH: 2 3/4"

G2113-P
 L: 15 5/16"xW: 9 13/16"xH: 2 3/4"

G2114-P
 L: 20 5/8"xW: 9 13/16"xH: 2 3/4"

G2122-P
 L: 15 5/16"xW: 9 3/4"xH: 2 3/4"

ORDERING GUIDE / YOUR PRODUCT CODE

SERIES/SHAPE	INPUT VOLTAGE	WATT	CCT	CRI	BEAM ANGLE	DIMMABLE	TRIM	FINISH
<input type="radio"/> G2111-P/Round Shape	<input type="radio"/> AC 12V	<input type="radio"/> 8W/lamp	<input type="radio"/> 3000K	<input type="radio"/> 80+	<input type="radio"/> 30°	<input type="radio"/> Non-Dimmable	<input type="radio"/> Smooth Trim	<input type="radio"/> White
<input type="radio"/> G2112-P/Round Shape	<input type="radio"/> DC 12V		<input type="radio"/> 4000K	<input type="radio"/> 90+	<input type="radio"/> 60°	<input type="radio"/> Dimmable	<input type="radio"/> Baffle Trim	<input type="radio"/> Black
<input type="radio"/> G2113-P/Round Shape			<input type="radio"/> 5000K					<input type="radio"/> Brown
<input type="radio"/> G2114-P/Round Shape								
<input type="radio"/> G2122-P/Round Shape								

*Other special requirements please confirm with our factory

SQUARE NEW CONSTRUCTION LED MULTIPLE DOWNLIGHT

LIGHT SOURCE COB LED G211X-P-S Series

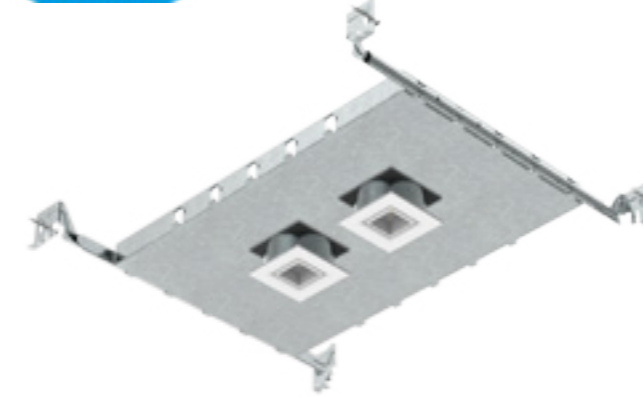

FEATURES

The simplified retrofit installation can be used in both new and existing spaces.
 IC Airtight for use with direct contact to insulation.
 1 inch light-emitting surface.
 Available in 1, 2, 3, 4, 2x2 lamps.
 Beam Angle: 30/60 Degrees.
 Life Rated for 50,000 hours at 70% lumen maintenance.
 Easy installation for new construction and remodel applications.

SPECIFICATION

Source: LED COB Chips.
 Lumen maintenance: 50,000 hours L70 based on LM80 standardized test results.
 Optics: PC Lens for even lumen distribution.
 Material: Die-cast aluminum construction for lasting quality.
 Mounting: New construction installation or remodel installation
 Electrical: High efficiency electronic driver.
 Heat dissipation: Superior Thermal Management by utilizing aluminum body as heat sink.

APPLICATIONS

Suitable for jewelry stores, boutiques, luxury goods stores, shopping malls and other places that require concentrated lighting and accent lighting.

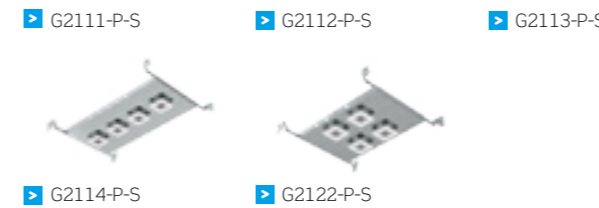

LISTING / WARRANTY

ETL listed to US and Canadian standards for damp location W/Feed through.
 3 Years Limited Warranty.



DIMENSIONS

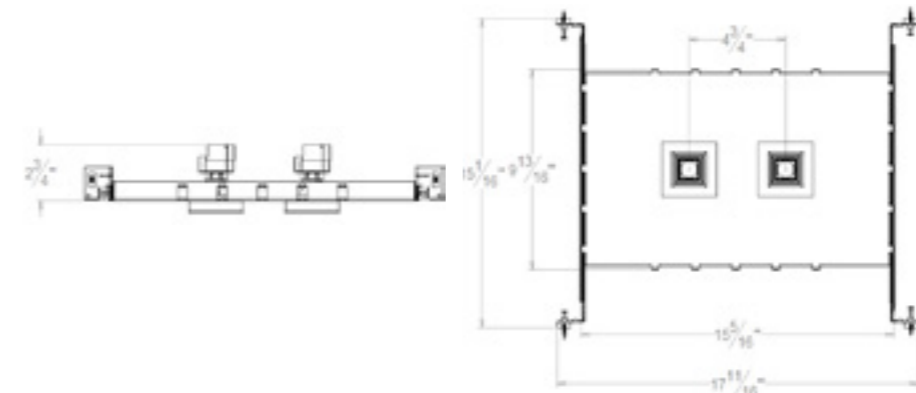

G2111-P-S
 L: 9 3/4"xW: 9 13/16"xH: 2 3/4"

G2112-P-S
 L: 15 5/16"xW: 9 13/16"xH: 2 3/4"

G2113-P-S
 L: 15 5/16"xW: 9 13/16"xH: 2 3/4"

G2114-P-S
 L: 20 5/8"xW: 9 13/16"xH: 2 3/4"

G2122-P-S
 L: 15 5/16"xW: 9 3/4"xH: 2 3/4"

ORDERING GUIDE / YOUR PRODUCT CODE

SERIES/SHAPE	INPUT VOLTAGE	WATT	CCT	CRI	BEAM ANGLE	DIMMABLE	TRIM	FINISH
<input type="radio"/> G2111-P-S/Square Shape	<input type="radio"/> AC 12V	<input type="radio"/> 8W/lamp	<input type="radio"/> 3000K	<input type="radio"/> 80+	<input type="radio"/> 30°	<input type="radio"/> Non-Dimmable	<input type="radio"/> Smooth Trim	<input type="radio"/> White
<input type="radio"/> G2112-P-S/Square Shape	<input type="radio"/> DC 12V		<input type="radio"/> 4000K	<input type="radio"/> 90+	<input type="radio"/> 60°	<input type="radio"/> Dimmable	<input type="radio"/> Baffle Trim	<input type="radio"/> Black
<input type="radio"/> G2113-P-S/Square Shape			<input type="radio"/> 5000K					<input type="radio"/> Brown
<input type="radio"/> G2114-P-S/Square Shape								
<input type="radio"/> G2122-P-S/Square Shape								

*Other special requirements please confirm with our factory



RECESSED BAFFLE LED DOWNLIGHT

This 2" LED Downlight Series is a high-performance, easy to install residential or commercial grade downlight solution that offers good light output, energy-efficiency and streamlined design, and it's available in remodel, new construction with mounting plate, and new construction with IC Airtight housing.

2" ROUND LED BAFFLE DOWNLIGHT



CONSTRUCTION

Cast aluminum trim routes heat away from electrical components
2" LED housing required for use of 2" LED Downlight Series

OPTICAL SYSTEM

Optical lens diffusers eliminate "hot spots", uniform light
Beam spread options available: Standard Flood, Narrow Flood

ELECTRICAL

Utilizes high performing LEDs with greater than 90 CRI and an R9 greater than 50
Dimmable to 10% with most standard triac dimmers
Operating temperature rating of 0°F to 120°F (-18°C to 49°C)
Lifetime rated for greater than 35,000 hours
LM-79, LM-80 testing performed in accordance with IESNA standards
120V input to driver

FINISH

Exterior white powder coat finish
Also available in Black, Oil-Rubbed Bronze and Nickel

INSTALLATION

2" recessed housings required: Available in remodel, new construction, and IC/Airtight new
Quick and easy installation with a snap-in IDEAL connector and friction clip mounting system

APPLICATIONS

Apply to automotive and parking, education, government, healthcare, hospitality, offices and banks, religious, retail.

120 _V Input Voltage	75 Lm/W System Efficacy	80/90 LED-CRI	8 _W Input Power	600 Lm Lumen Output	3000K 4000K 5000K CCT
-----------------------------------	-------------------------------	------------------	-------------------------------	---------------------------	--------------------------------

LISTING / WARRANTY

ETL listed to US and Canadian standards for damp location W/Feed through.
5 Years Limited Warranty.



DIMENSIONS

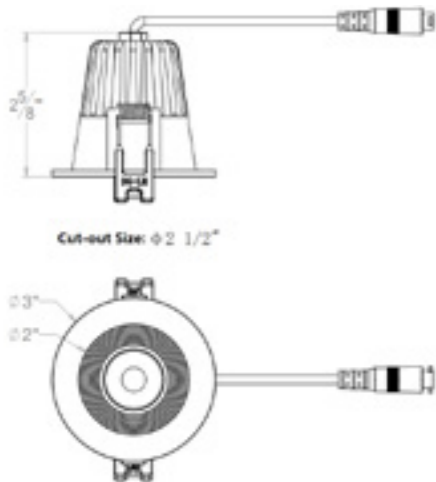

ORDERING GUIDE / YOUR PRODUCT CODE

SERIES/SHAPE	LUMEN	VOLTAGE	CCT	FINISH	DIMMABLE	OPTICAL
<input type="radio"/> BL2-R/Round Shape 2" LED Downlight	<input type="radio"/> 600lm	<input type="radio"/> AC 120V	<input type="radio"/> 3000K <input type="radio"/> 4000K <input type="radio"/> 5000K	<input type="radio"/> White <input type="radio"/> Nickel <input type="radio"/> Black <input type="radio"/> Oil Rubbed Bronze	<input type="radio"/> Non-Dimmable <input type="radio"/> Dimmable	<input type="radio"/> 24° <input type="radio"/> 36°

* Customized Also Available



2" SQUARE LED BAFFLE DOWNLIGHT



CONSTRUCTION

Cast aluminum trim routes heat away from electrical components
2" LED housing required for use of 2" LED Downlight Series

OPTICAL SYSTEM

Optical lens diffusers eliminate "hot spots", uniform light
Beam spread options available: Standard Flood, Narrow Flood

ELECTRICAL

Utilizes high performing LEDs with greater than 90 CRI and an R9 greater than 50
Dimmable to 10% with most standard triac dimmers
Operating temperature rating of 0°F to 120°F (-18°C to 49°C)
Lifetime rated for greater than 35,000 hours
LM-79, LM-80 testing performed in accordance with IESNA standards
120V input to driver

FINISH

Exterior white powder coat finish
Also available in Black, Oil-Rubbed Bronze and Nickel

INSTALLATION

2" recessed housings required: Available in remodel, new construction, and IC/Airtight new
Quick and easy installation with a snap-in IDEAL connector and friction clip mounting system

APPLICATIONS

Apply to automotive and parking, education, government, healthcare, hospitality, offices and banks, religious, retail.

120 _V Input Voltage	75 Lm/W System Efficacy	80/90 LED-CRI	8 _W Input Power	600 Lm Lumen Output	3000K 4000K 5000K CCT
-----------------------------------	-------------------------------	------------------	-------------------------------	---------------------------	--------------------------------

LISTING / WARRANTY

ETL listed to US and Canadian standards for damp location W/Feed through.
5 Years Limited Warranty.



DIMENSIONS

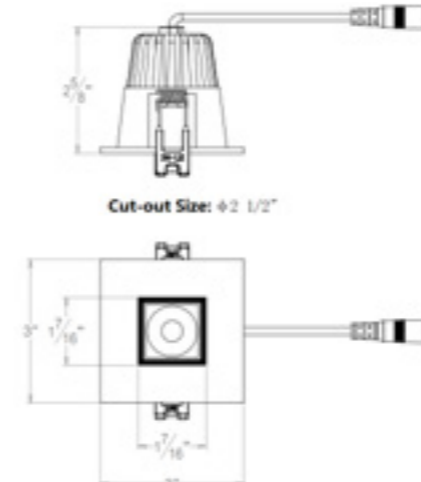

ORDERING GUIDE / YOUR PRODUCT CODE

SERIES/SHAPE	LUMEN	VOLTAGE	CCT	FINISH	DIMMABLE	OPTICAL
<input type="radio"/> BL2-S/Square Shape 2" LED Downlight	<input type="radio"/> 600lm	<input type="radio"/> AC 120V	<input type="radio"/> 3000K <input type="radio"/> 4000K <input type="radio"/> 5000K	<input type="radio"/> White <input type="radio"/> Nickel <input type="radio"/> Black <input type="radio"/> Oil Rubbed Bronze	<input type="radio"/> Non-Dimmable <input type="radio"/> Dimmable	<input type="radio"/> 24° <input type="radio"/> 36°

* Customized Also Available

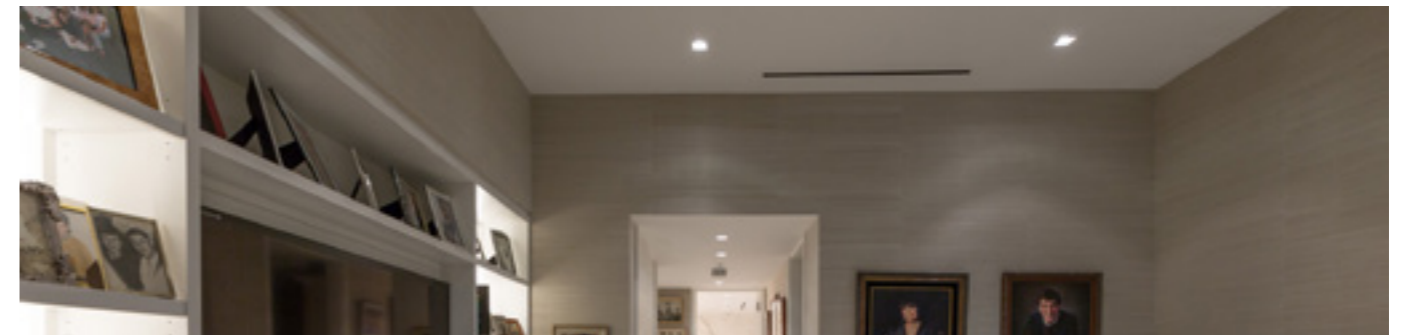

2" NEW CONSTRUCTION IC AIRTIGHT ROUND LED BAFFLE DOWNLIGHT

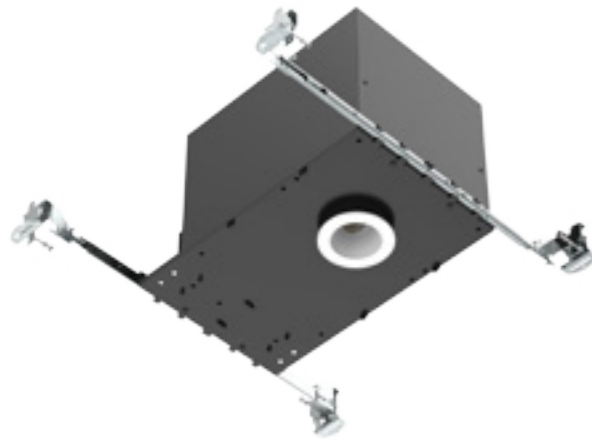
BL2-R-IA
**CONSTRUCTION**

Cast aluminum trim routes heat away from electrical components
2" LED housing required for use of 2" LED Downlight Series

OPTICAL SYSTEM

Optical lens diffusers eliminate "hot spots", uniform light
Beam spread options available: Standard Flood, Narrow Flood

ELECTRICAL

Utilizes high performing LEDs with greater than 90 CRI and an R9 greater than 50
Dimmable to 10% with most standard triac dimmers
Operating temperature rating of 0°F to 120°F (-18°C to 49°C)
Lifetime rated for greater than 35,000 hours
LM-79, LM-80 testing performed in accordance with IESNA standards
120V input to driver

FINISH

Exterior white powder coat finish
Also available in Black, Oil-Rubbed Bronze and Nickel

INSTALLATION

2" recessed housings required: Available in remodel, new construction, and IC/Airtight new
Quick and easy installation with a snap-in IDEAL connector and friction clip mounting system

APPLICATIONS

Apply to automotive and parking, education, government, healthcare, hospitality, offices and banks, religious, retail.

**LISTING / WARRANTY**

ETL listed to US and Canadian standards for damp location W/Feed through.
5 Years Limited Warranty.

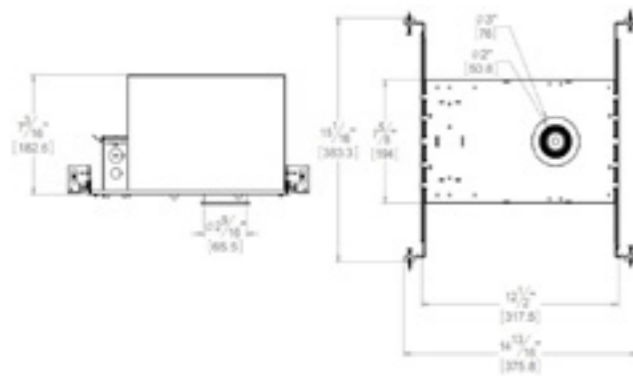
**DIMENSIONS****ORDERING GUIDE / YOUR PRODUCT CODE**

SERIES/SHAPE	LUMEN	VOLTAGE	CCT	FINISH	DIMMABLE	OPTICAL
<input type="radio"/> BL2-R-IA/Round Shape 2" LED Downlight	<input type="radio"/> 600lm	<input type="radio"/> AC 120V	<input type="radio"/> 3000K <input type="radio"/> 4000K <input type="radio"/> 5000K	<input type="radio"/> White <input type="radio"/> Nickel <input type="radio"/> Black <input type="radio"/> Oil Rubbed Bronze	<input type="radio"/> Non-Dimmable <input type="radio"/> Dimmable	<input type="radio"/> 24° <input type="radio"/> 36°

* Customized Also Available

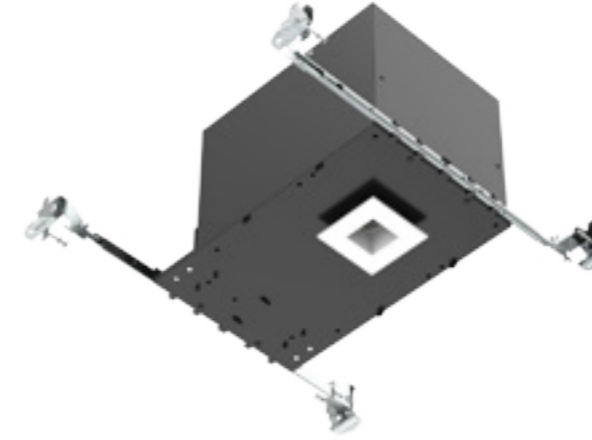

2" NEW CONSTRUCTION IC AIRTIGHT SQUARE LED BAFFLE DOWNLIGHT

BL2-S-IA
**CONSTRUCTION**

Cast aluminum trim routes heat away from electrical components
2" LED housing required for use of 2" LED Downlight Series

OPTICAL SYSTEM

Optical lens diffusers eliminate "hot spots", uniform light
Beam spread options available: Standard Flood, Narrow Flood

ELECTRICAL

Utilizes high performing LEDs with greater than 90 CRI and an R9 greater than 50
Dimmable to 10% with most standard triac dimmers
Operating temperature rating of 0°F to 120°F (-18°C to 49°C)
Lifetime rated for greater than 35,000 hours
LM-79, LM-80 testing performed in accordance with IESNA standards
120V input to driver

FINISH

Exterior white powder coat finish
Also available in Black, Oil-Rubbed Bronze and Nickel

INSTALLATION

2" recessed housings required: Available in remodel, new construction, and IC/Airtight new
Quick and easy installation with a snap-in IDEAL connector and friction clip mounting system

APPLICATIONS

Apply to automotive and parking, education, government, healthcare, hospitality, offices and banks, religious, retail.

**LISTING / WARRANTY**

ETL listed to US and Canadian standards for damp location W/Feed through.
5 Years Limited Warranty.

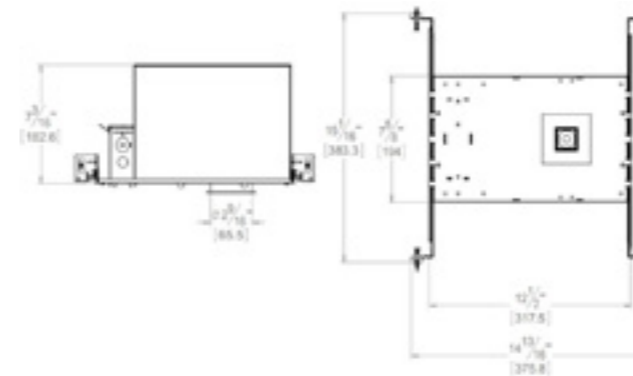
**DIMENSIONS****ORDERING GUIDE / YOUR PRODUCT CODE**

SERIES/SHAPE	LUMEN	VOLTAGE	CCT	FINISH	DIMMABLE	OPTICAL
<input type="radio"/> BL2-S-IA/Square Shape 2" LED Downlight	<input type="radio"/> 600lm	<input type="radio"/> AC 120V	<input type="radio"/> 3000K <input type="radio"/> 4000K <input type="radio"/> 5000K	<input type="radio"/> White <input type="radio"/> Nickel <input type="radio"/> Black <input type="radio"/> Oil Rubbed Bronze	<input type="radio"/> Non-Dimmable <input type="radio"/> Dimmable	<input type="radio"/> 24° <input type="radio"/> 36°

* Customized Also Available



2" NEW CONSTRUCTION ROUND LED BAFFLE DOWNLIGHT



CONSTRUCTION

Cast aluminum trim routes heat away from electrical components
2" LED housing required for use of 2" LED Downlight Series

OPTICAL SYSTEM

Optical lens diffusers eliminate "hot spots", uniform light
Beam spread options available: Standard Flood, Narrow Flood

ELECTRICAL

Utilizes high performing LEDs with greater than 90 CRI and an R9 greater than 50
Dimmable to 10% with most standard triac dimmers
Operating temperature rating of 0°F to 120°F (-18°C to 49°C)
Lifetime rated for greater than 35,000 hours
LM-79, LM-80 testing performed in accordance with IESNA standards
120V input to driver

FINISH

Exterior white powder coat finish
Also available in Black, Oil-Rubbed Bronze and Nickel

INSTALLATION

2" recessed housings required: Available in remodel, new construction, and IC/Airtight new
Quick and easy installation with a snap-in IDEAL connector and friction clip mounting system

APPLICATIONS

Apply to automotive and parking, education, government, healthcare, hospitality, offices and banks, religious, retail.

120V Input Voltage	75 Lm/W System Efficacy	80/90 LED CRI	8W Input Power	600 Lm Lumen Output	3000K 4000K 5000K CCT
-----------------------	-------------------------------	------------------	-------------------	---------------------------	--------------------------------

LISTING / WARRANTY

ETL listed to US and Canadian standards
for damp location W/Feed through.
5 Years Limited Warranty.



DIMENSIONS

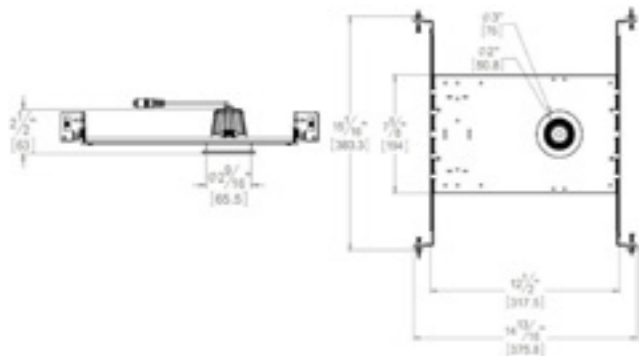

ORDERING GUIDE / YOUR PRODUCT CODE

SERIES/SHAPE	LUMEN	VOLTAGE	CCT	FINISH	DIMMABLE	OPTICAL
<input type="radio"/> BL2-R-NC/Round Shape 2" LED Downlight	<input type="radio"/> 600lm	<input type="radio"/> AC 120V	<input type="radio"/> 3000K <input type="radio"/> 4000K <input type="radio"/> 5000K	<input type="radio"/> White <input type="radio"/> Nickel <input type="radio"/> Black <input type="radio"/> Oil Rubbed Bronze	<input type="radio"/> Non-Dimmable <input type="radio"/> Dimmable	<input type="radio"/> 24° <input type="radio"/> 36°

* Customized Also Available



2" NEW CONSTRUCTION SQUARE LED BAFFLE DOWNLIGHT

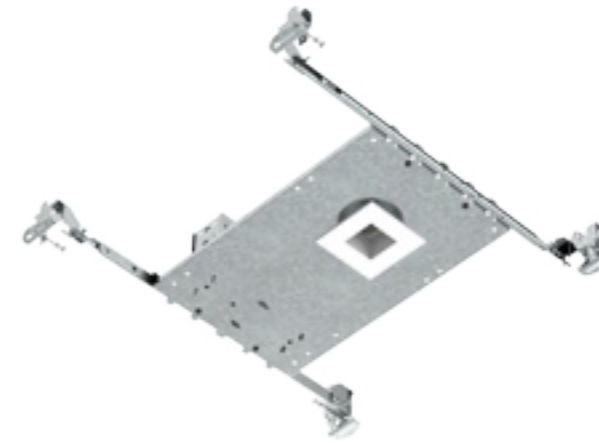

CONSTRUCTION

Cast aluminum trim routes heat away from electrical components
2" LED housing required for use of 2" LED Downlight Series

OPTICAL SYSTEM

Optical lens diffusers eliminate "hot spots", uniform light
Beam spread options available: Standard Flood, Narrow Flood

ELECTRICAL

Utilizes high performing LEDs with greater than 90 CRI and an R9 greater than 50
Dimmable to 10% with most standard triac dimmers
Operating temperature rating of 0°F to 120°F (-18°C to 49°C)
Lifetime rated for greater than 35,000 hours
LM-79, LM-80 testing performed in accordance with IESNA standards
120V input to driver

FINISH

Exterior white powder coat finish
Also available in Black, Oil-Rubbed Bronze and Nickel

INSTALLATION

2" recessed housings required: Available in remodel, new construction, and IC/Airtight new
Quick and easy installation with a snap-in IDEAL connector and friction clip mounting system

APPLICATIONS

Apply to automotive and parking, education, government, healthcare, hospitality, offices and banks, religious, retail.

120V Input Voltage	75 Lm/W System Efficacy	80/90 LED CRI	8W Input Power	600 Lm Lumen Output	3000K 4000K 5000K CCT
-----------------------	-------------------------------	------------------	-------------------	---------------------------	--------------------------------

LISTING / WARRANTY

ETL listed to US and Canadian standards
for damp location W/Feed through.
5 Years Limited Warranty.



DIMENSIONS

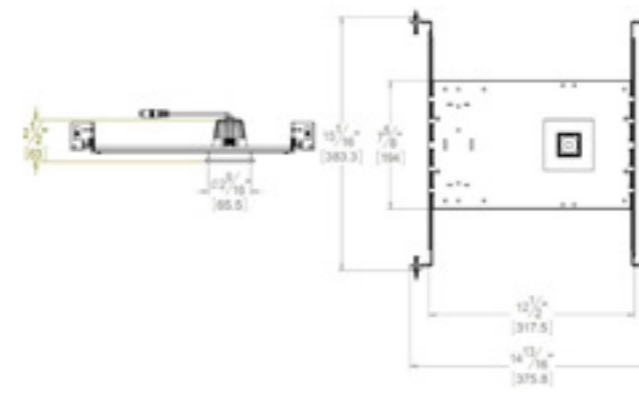

ORDERING GUIDE / YOUR PRODUCT CODE

SERIES/SHAPE	LUMEN	VOLTAGE	CCT	FINISH	DIMMABLE	OPTICAL
<input type="radio"/> BL2-S-NC/Square Shape 2" LED Downlight	<input type="radio"/> 600lm	<input type="radio"/> AC 120V	<input type="radio"/> 3000K <input type="radio"/> 4000K <input type="radio"/> 5000K	<input type="radio"/> White <input type="radio"/> Nickel <input type="radio"/> Black <input type="radio"/> Oil Rubbed Bronze	<input type="radio"/> Non-Dimmable <input type="radio"/> Dimmable	<input type="radio"/> 24° <input type="radio"/> 36°

* Customized Also Available

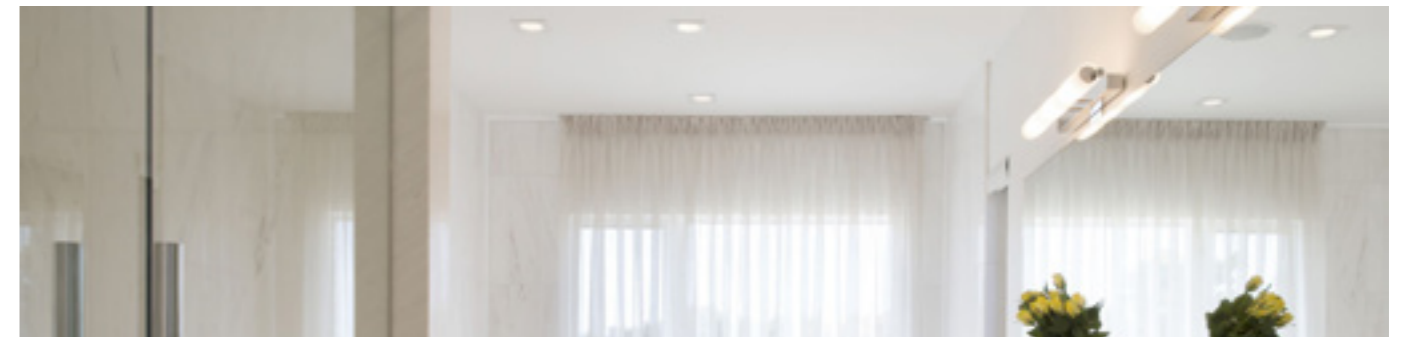



Wesake™

Ultra-Thin $\frac{1}{2}$ "

ULTRA-THIN LED RECESSED PANEL LIGHT

Liteharbor Ultra-thin LED Recessed Panel Light Series for insulated ceiling, including the junction box and driver. The thin profile with spring clips allows for quick and easy installation. Ideal for confined spaces. The small size led panel light in size 4" and 6", in round or square shape.

FIRST PROPOSED THE CONCEPT OF NEW CONSTRUCTION PANEL LIGHT.

Trimless design for the FIRST time applied to ultra-thin panel light.

FIRST gimbal design used in panel light.

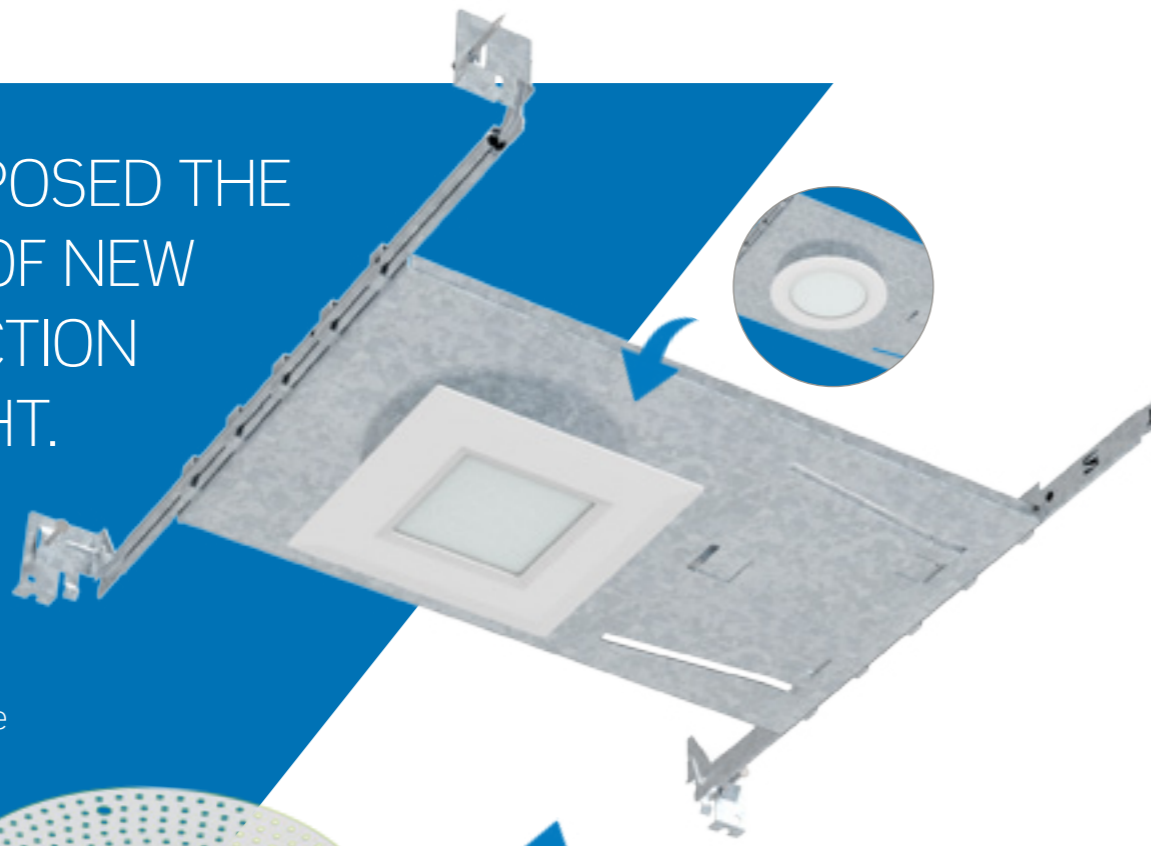

Share a mounting plate with Square look Round aperture unique design.



The original design The latest design

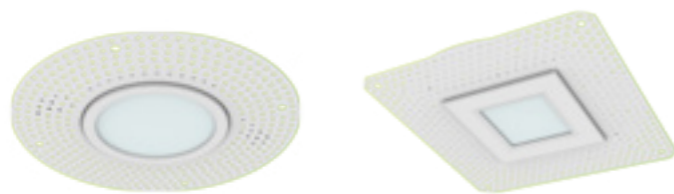

□ Round □ Square

Round or Square type outer shape is optional.



IC/NON-IC both available.

ULTRA-THIN

1/2"



New Sleek Design



Back Light Leakage Prevention



Super Fast Mounting Clips



High Efficiency Driver

PARTS LIST

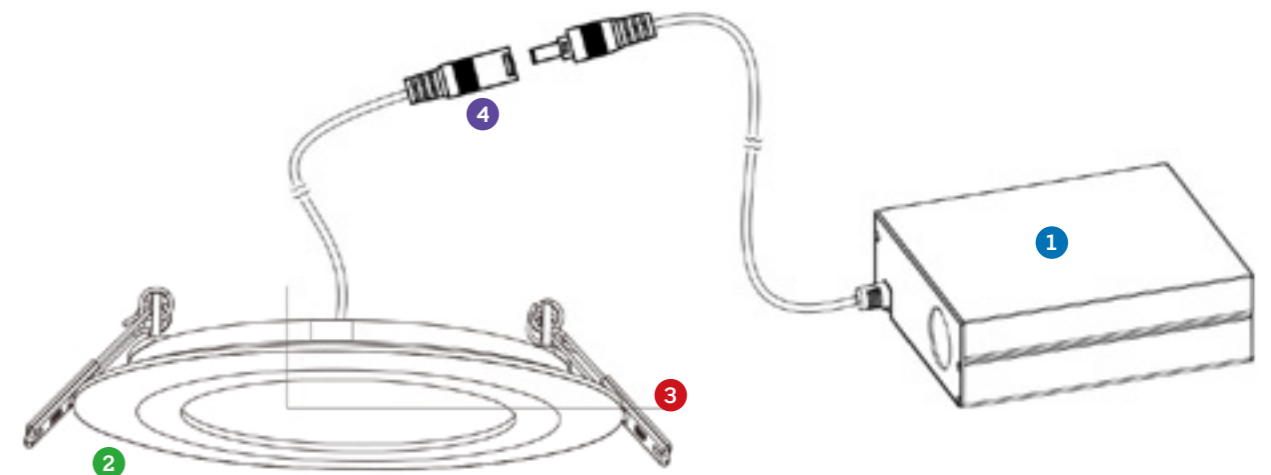

- 1 Junction Box & Driver
- 2 Light Panel
- 3 Spring Clips
- 4 Connector

ULTRA-THIN LED RECESSED PANEL LIGHT

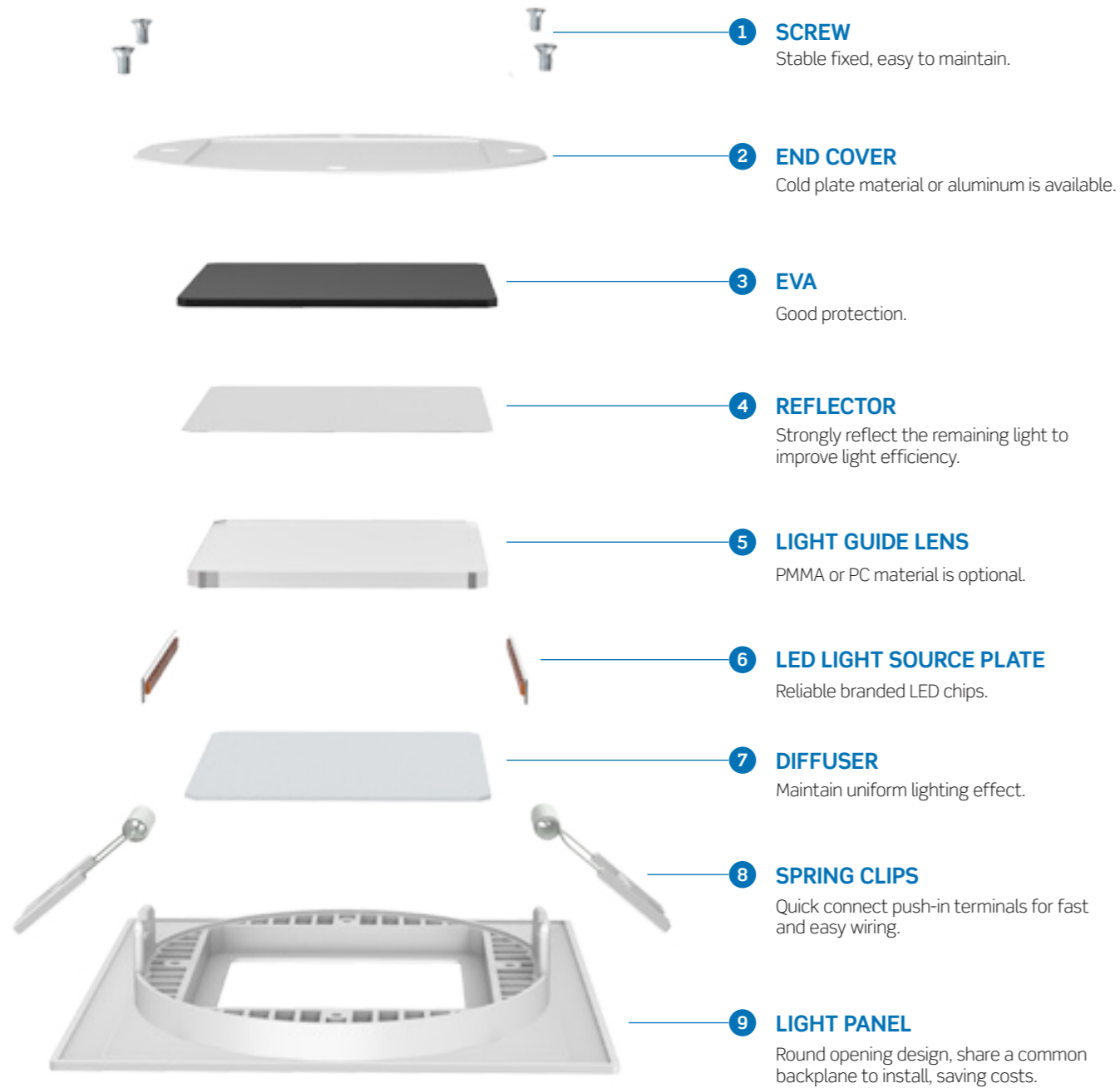

All Liteharbor Panels are offered with 3-Year limited warranty. A robust sleek design, state-of-the-art engineering and a rigorous testing regimen are all factors that make our products so reliable. All the LED panel lights are cETLus listed. They can be well sold in North America market.

INSTALLATION INSTRUCTIONS

Turn power OFF from the electrical panel prior to installation.

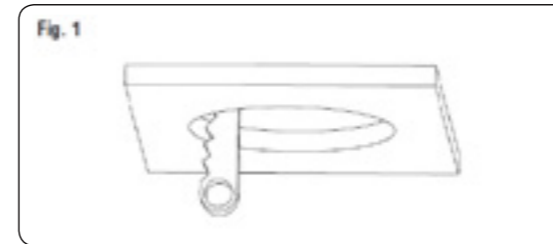

-Determine the location for installation and cut ceiling hole in accordance with cut-hole dimensions. Refer to hole diameter table for appropriate sizes.

Fig. 1

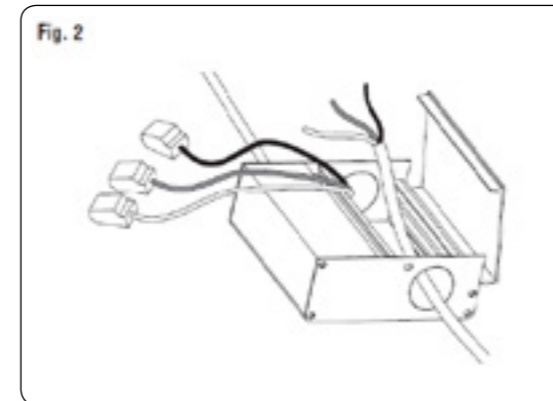

-Open the junction box cover and remove the appropriate knockout(s) on the side panel. (Fig. 2)
-Insert the electrical supply cable through the knockout and secure with a cable connector (sold separately).
-Using quick-connect push-in terminals, connect the ground wire to the green wire terminal; black wire to black wire terminal; white wire to white wire terminal.

Fig. 2



-Place all wiring and connections back in to the box and close the cover. Connect the driver to the light panel.
-Insert junction box through the mounting hole.

Fig. 3

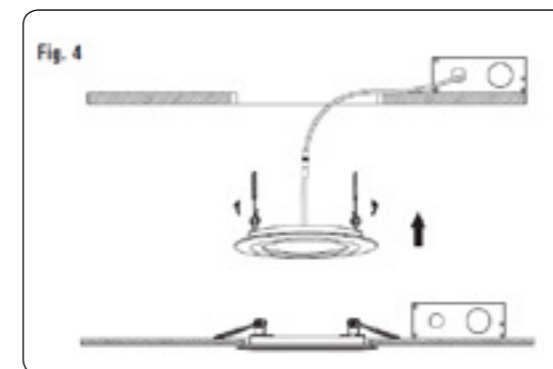

-Push spring-loaded clips on the fixture upwards and insert fixture base in to the mounting hole. Release the clips and fixture will be pulled flush to the ceiling.

Fig. 4

3" ULTRA THIN RECESSED LED PANEL LIGHT

LIGHT SOURCE SMD CHIPS **BL3-301**



DESCRIPTION

This 3 inch 6W ultra thin recessed LED panel light, is a kind of high performance and easy installation residential downlight, provides smooth and gentle light output, efficient energy saving. Using two clips to install, easy for installation and saving time, tool-free, no need housing, suitable for 1/2" to 1 1/4" ceiling thickness. Using FT4 cable, with quick anti-pull connecting terminal, good anti-pull performance. Streamlined panels, the lamp is concise and beautiful. Dimmable, compatible dimmer, can match the multi-brand dimmer, good dimming effect (stability, no flickering). Application: Automotive and Parking, Education, Government, Healthcare, Hospitality, Offices and Banks, Religious, Retail)

LAMP BODY

Aluminum die casting, high thermal conductivity, superior heat dissipation performance, the lower light decline, prolong the life of lamps, white powder, paint processing, durable and colorfast.

LIGHT SOURCE

Using top brand 2835 SMD LED light source, chip is durable and stability, superior performance and luminous uniform, high lumen, the light color consistency is good, low light decline, long lifespan; Life Rated for 36000 hours at 70% lumen maintenance.



DIMENSIONS

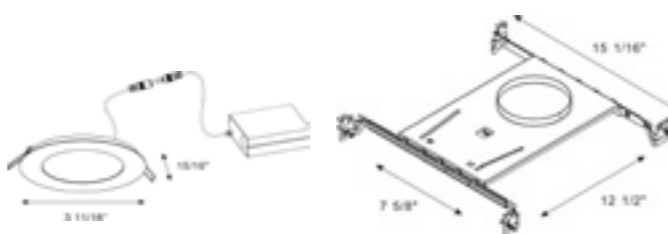

Remodel

New Construction

BL3-301 | Remodel

BL3-301-NC
New Construction

ORDERING GUIDE / YOUR PRODUCT CODE

SERIES	MOUNTING	TRIM	INPUT VOLTAGE	CCT	DIMMABLE	FINISH
BL3-301 3" Round Recessed LED Panel	Remodel	Trimmed	120V	2700K	Non-Dimmable	White
		Trimless	277V	3000K	Dimmable	Black
	New Construction		4000K		Satin Nickel	
			5000K			
			6000K			

* Customized Also Available

LISTING / WARRANTY

ETL listed to US and Canadian standards for damp location W/Feed through. 3 Years Limited Warranty.



3" ULTRA THIN RECESSED SQUARE LED PANEL LIGHT

LIGHT SOURCE SMD CHIPS **BL3-S301**



DESCRIPTION

This 3 inch 6W ultra thin recessed LED panel light, is a kind of high performance and easy installation residential downlight, provides smooth and gentle light output, efficient energy saving. Using two clips to install, easy for installation and saving time, tool-free, no need housing, suitable for 1/2" to 1 1/4" ceiling thickness. Using FT4 cable, with quick anti-pull connecting terminal, good anti-pull performance. Streamlined panels, the lamp is concise and beautiful. Dimmable, compatible dimmer, can match the multi-brand dimmer, good dimming effect (stability, no flickering). Application: Automotive and Parking, Education, Government, Healthcare, Hospitality, Offices and Banks, Religious, Retail)

LAMP BODY

Aluminum die casting, high thermal conductivity, superior heat dissipation performance, the lower light decline, prolong the life of lamps, white powder, paint processing, durable and colorfast.

LIGHT SOURCE

Using top brand 2835 SMD LED light source, chip is durable and stability, superior performance and luminous uniform, high lumen, the light color consistency is good, low light decline, long lifespan; Life Rated for 36000 hours at 70% lumen maintenance.



DIMENSIONS

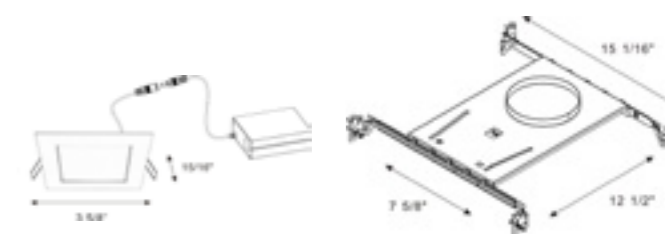

Remodel

New Construction

BL3-S301 | Remodel

BL3-S301-NC
New Construction

* Square and Round Items share one mounting plate of round aperture.

ORDERING GUIDE / YOUR PRODUCT CODE

SERIES	MOUNTING	TRIM	INPUT VOLTAGE	CCT	DIMMABLE	FINISH
BL3-S301 3" Square Recessed LED Panel	Remodel	Trimmed	120V	2700K	Non-Dimmable	White
		Trimless	277V	3000K	Dimmable	Black
	New Construction		4000K		Satin Nickel	
			5000K			
			6000K			

* Customized Also Available

LISTING / WARRANTY

ETL listed to US and Canadian standards for damp location W/Feed through. 3 Years Limited Warranty.



4" ULTRA-THIN ROUND LED RECESSED PANEL LIGHT

LIGHT SOURCE SMD CHIPS **BL4-301**



DESCRIPTION

This ultra thin recessed LED Panel is absolutely perfect for tight spaces, soffits and insulated and dropped ceilings. Recessed 4" Round LED Panel with integral driver in connection box. Fits where no other recessed fixture can. This LED is 10 watts and replaces a 50 watt halogen save up to 80% energy for same light output. The thin panel profile with spring clips allows for quick and easy installation. Ideal for confined spaces and suitable for damp locations.

FEATURES

Available in All 4" Round Openings
Retrofit or New Construction 1/2" Thin - Install Directly Under Joists, Maximum Layout Flexibility
Comes with Junction Box & Driver, No Housing Required Fast & Easy To Install

MOUNTING

Cut Hole In Ceiling And Snap Fixture In Opening With Attached Spring Clips. 2" Above Ceiling Clearance Required For Driver.

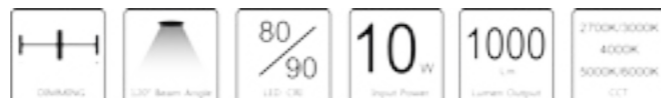

DIMENSIONS

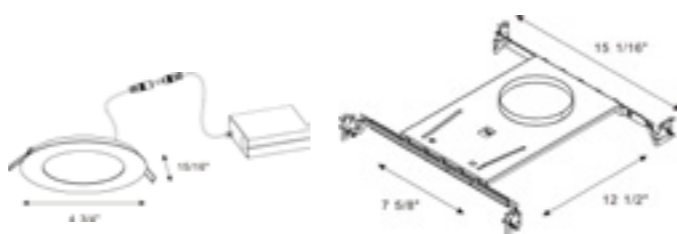

Remodel

New Construction

BL4-301 | Remodel

BL4-301-NC
New Construction

ORDERING GUIDE / YOUR PRODUCT CODE

SERIES	MOUNTING	TRIM	INPUT VOLTAGE	CCT	DIMMABLE	FINISH
○ BL4-301	○ Remodel	○ Trimmed	○ 120V	○ 2700K	○ Non-Dimmable	○ White
○ 4" Round Recessed LED Panel	○ New Construction	○ Trimless	○ 277V	○ 3000K	○ Dimmable	○ Black
				○ 4000K		○ Satin Nickel
				○ 5000K		
				○ 6000K		

* Customized Also Available

LISTING / WARRANTY

ETL listed to US and Canadian standards for damp location W/Feed through. 3 Years Limited Warranty.



4" ULTRA-THIN SQUARE LED RECESSED PANEL LIGHT

LIGHT SOURCE SMD CHIPS **BL4-S301**



DESCRIPTION

This ultra thin recessed LED Panel is absolutely perfect for tight spaces, soffits and insulated and dropped ceilings. Recessed 4" Round LED Panel with integral driver in connection box. Fits where no other recessed fixture can. This LED is 10 watts and replaces a 50 watt halogen save up to 80% energy for same light output. The thin panel profile with spring clips allows for quick and easy installation. Ideal for confined spaces and suitable for damp locations.

FEATURES

Available in All 4" Round Openings.
Retrofit or New Construction Install Directly Under Joists, Maximum Layout Flexibility.
Comes with Junction Box & Driver, No Housing Required Fast & Easy To Install.

MOUNTING

Cut Hole In Ceiling And Snap Fixture In Opening With Attached Spring Clips. 2" Above Ceiling Clearance Required For Driver.



DIMENSIONS

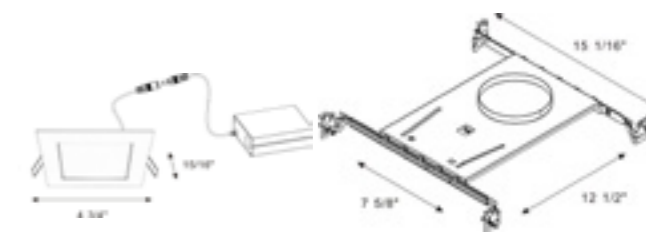

Remodel

New Construction

BL4-S301 | Remodel

BL4-S301-NC
New Construction

* Square and Round Items share one mounting plate of round aperture.

ORDERING GUIDE / YOUR PRODUCT CODE

SERIES	MOUNTING	TRIM	INPUT VOLTAGE	CCT	DIMMABLE	FINISH
○ BL4-S301	○ Remodel	○ Trimmed	○ 120V	○ 2700K	○ Non-Dimmable	○ White
○ 4" Square Recessed LED Panel	○ New Construction	○ Trimless	○ 277V	○ 3000K	○ Dimmable	○ Black
				○ 4000K		○ Satin Nickel
				○ 5000K		
				○ 6000K		

* Customized Also Available

LISTING / WARRANTY

ETL listed to US and Canadian standards for damp location W/Feed through. 3 Years Limited Warranty.



6" ULTRA-THIN ROUND LED RECESSED PANEL LIGHT



DESCRIPTION

This ultra thin recessed LED Panel is absolutely perfect for tight spaces, soffits and insulated and dropped ceilings. Recessed 6" round LED Panel with integral driver in connection box. Fits where no other recessed fixture can. This LED is 12 watts and replaces a 65 watt halogen save up to 80% energy for same light output. The thin panel profile with spring clips allows for quick and easy installation. Ideal for confined spaces and suitable for damp locations.

FEATURES

Available in All 6" Round Openings
Retrofit or New Construction Install Directly Under Joists, Maximum Layout Flexibility.
Comes with Junction Box & Driver, No Housing Required Fast & Easy To Install.

MOUNTING

Cut Hole In Ceiling And Snap Fixture In Opening With Attached Spring Clips. 2" Above Ceiling Clearance Required For Driver.

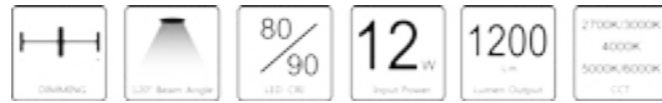

BL6-301-NC
New Construction

DIMENSIONS

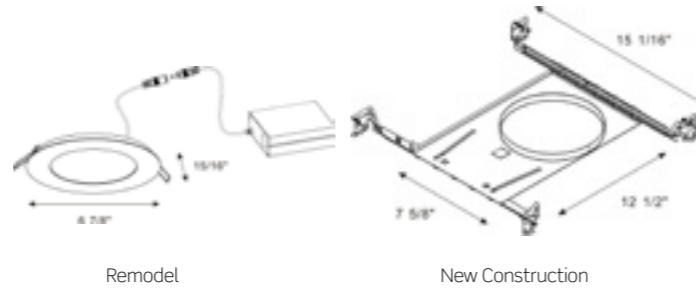

ORDERING GUIDE / YOUR PRODUCT CODE

SERIES	MOUNTING	TRIM	INPUT VOLTAGE	CCT	DIMMABLE	FINISH
<input type="radio"/> BL6-301	<input type="radio"/> Remodel	<input type="radio"/> Trimmed	<input type="radio"/> 120V	<input type="radio"/> 2700K	<input type="radio"/> Non-Dimmable	<input type="radio"/> White
6" Round Recessed LED Panel	<input type="radio"/> New Construction	<input type="radio"/> Trimless	<input type="radio"/> 277V	<input type="radio"/> 3000K	<input type="radio"/> Dimmable	<input type="radio"/> Black
				<input type="radio"/> 4000K		<input type="radio"/> Satin Nickel
				<input type="radio"/> 5000K		
				<input type="radio"/> 6000K		

* Customized Also Available

LISTING / WARRANTY

ETL listed to US and Canadian standards for damp location W/Feed through. 3 Years Limited Warranty.



6" ULTRA-THIN SQUARE LED RECESSED PANEL LIGHT



DESCRIPTION

This ultra thin recessed LED Panel is absolutely perfect for tight spaces, soffits and insulated and dropped ceilings. Recessed 6" Square LED Panel with integral driver in connection box. Fits where no other recessed fixture can. This LED is 12 watts and replaces a 65 watt halogen save up to 80% energy for same light output. The thin panel profile with spring clips allows for quick and easy installation. Ideal for confined spaces and suitable for damp locations.

FEATURES

Available in All 6" Round Openings
Retrofit or New Construction Install Directly Under Joists, Maximum Layout Flexibility.
Comes with Junction Box & Driver, No Housing Required Fast & Easy To Install.

MOUNTING

Cut Hole In Ceiling And Snap Fixture In Opening With Attached Spring Clips. 2" Above Ceiling Clearance Required For Driver.

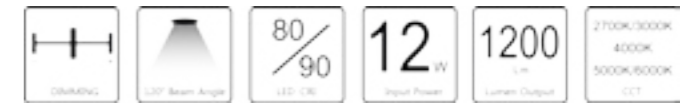

BL6-S301-NC
New Construction

DIMENSIONS

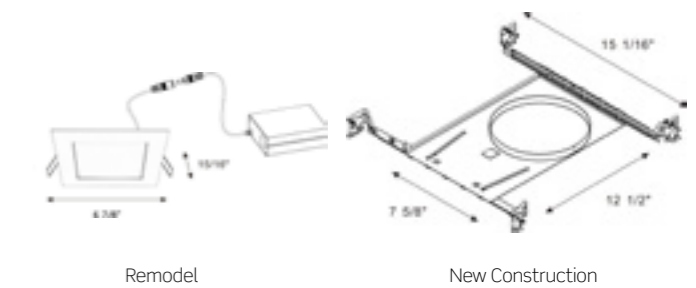

* Square and Round Items share one mounting plate of round aperture.

ORDERING GUIDE / YOUR PRODUCT CODE

SERIES	MOUNTING	TRIM	INPUT VOLTAGE	CCT	DIMMABLE	FINISH
<input type="radio"/> BL6-S301	<input type="radio"/> Remodel	<input type="radio"/> Trimmed	<input type="radio"/> 120V	<input type="radio"/> 2700K	<input type="radio"/> Non-Dimmable	<input type="radio"/> White
6" Square Recessed LED Panel	<input type="radio"/> New Construction	<input type="radio"/> Trimless	<input type="radio"/> 277V	<input type="radio"/> 3000K	<input type="radio"/> Dimmable	<input type="radio"/> Black
				<input type="radio"/> 4000K		<input type="radio"/> Satin Nickel
				<input type="radio"/> 5000K		
				<input type="radio"/> 6000K		

* Customized Also Available

LISTING / WARRANTY

ETL listed to US and Canadian standards for damp location W/Feed through. 3 Years Limited Warranty.





ULTRA-THIN GIMBAL

ULTRA-THIN GIMBAL LED RECESSED LIGHT

Liteharbor Ultra-thin LED Gimbal Recessed Panel Light Series for Insulated Ceiling, including the junction box and driver. Gimbal LED Series is designed for 9° tilt. The thin profile with spring clips allows for quick and easy installation. Ideal for confined spaces. The small size led panel light in size 4" and 6", in round shape.

3" SUPER-THIN GIMBAL LED RECESSED PANEL LIGHT

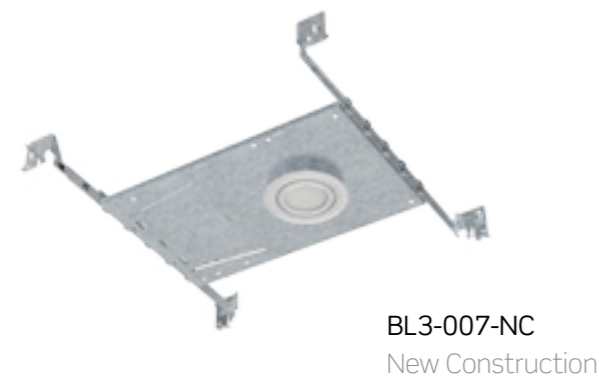

DESCRIPTION

The 6W super-thin gimbal recessed panel light is a high performance, easy installation of the residential lighting. Provides a good light output, good light, smooth and soft, high efficiency and energy saving. Using aluminum casting, good heat dissipation, simple and beautiful modelling of appearance. Dimmable, good compatibility matched with multi-brand dimmers, dimming stable and even, no strobe. Easy installation and time-saving, tool-free, no housing. New construction optional. The innovation type gimbal panel light, adjustable lighting direction, meet the demand for multiple lighting.

SPECIFICATION

Wattage: 6W
Input Voltage: 120V

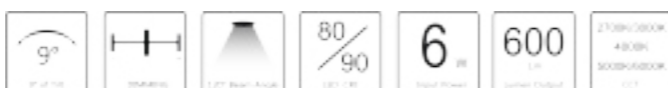

MOUNTING CLIPS OPTIONAL

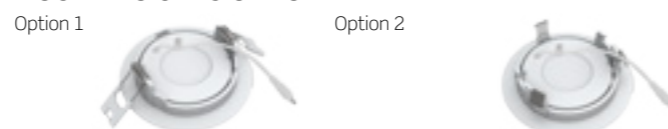

DIMENSIONS

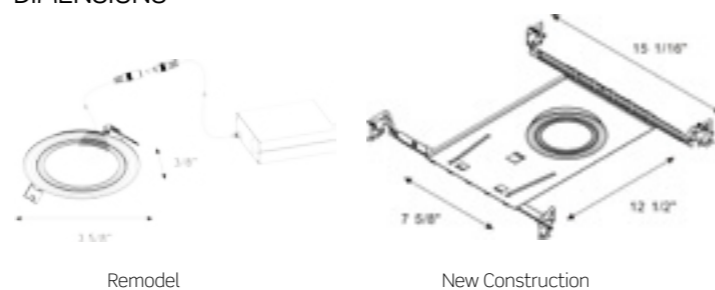

ORDERING GUIDE / YOUR PRODUCT CODE

SERIES	MOUNTING	TRIM	CCT	DIMMABLE	FINISH	MOUNTING CLIPS OPTIONAL
○ BL3-007 3" Gimbal Panel Light	○ Remodel ○ New Construction ○ IC airtight	○ Trimmed ○ Trimless	○ 2700K ○ 3000K ○ 3500K ○ 4100K	○ Non-Dimmable ○ Dimmable	○ White ○ Black ○ Satin Nickel	○ Option 1 ○ Option 2 (Reference to the following page)

* Customized Also Available

LISTING / WARRANTY

ETL listed to US and Canadian standards for damp location W/Feed through.
3 Years Limited Warranty.



4" ULTRA-THIN GIMBAL LED RECESSED LIGHT



DESCRIPTION

This ultra thin recessed LED Panel is absolutely perfect for tight spaces, soffits and insulated and dropped ceilings. Recessed 4" Round LED Panel with integral driver in connection box. Fits where no other recessed fixture can. This LED is 9 watts and replaces a 50 watt halogen save up to 80% energy for same light output. The thin panel profile with spring clips allows for quick and easy installation. Ideal for confined spaces and suitable for damp locations.

FEATURES

Available in All 4" Round Openings
Retrofit or New Construction 1/2" Thin - Install Directly Under Joists,
Maximum Layout Flexibility
Comes with Junction Box & Driver, No Housing Required Fast & Easy To Install

MOUNTING

Cut Hole In Ceiling And Snap Fixture In Opening With Attached Spring Clips.
2" Above Ceiling Clearance Required For Driver.



DIMENSIONS

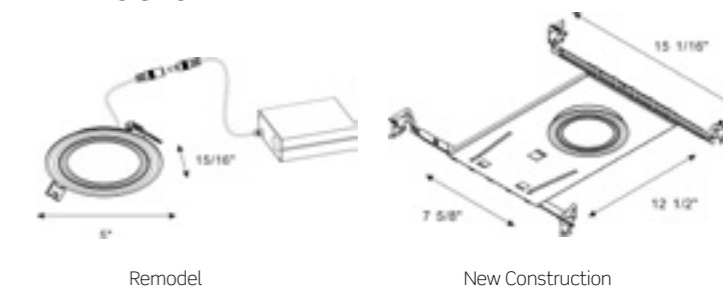

ORDERING GUIDE / YOUR PRODUCT CODE

SERIES	MOUNTING	TRIM	INPUT VOLTAGE	CCT	DIMMABLE	FINISH
○ BL4-007 4" Gimbal Recessed LED Panel	○ Remodel ○ New Construction ○ IC airtight	○ Trimmed ○ Trimless	○ 120V ○ 277V	○ 2700K ○ 3000K ○ 4000K ○ 5000K ○ 6000K	○ Non-Dimmable ○ Dimmable	○ White ○ Black ○ Satin Nickel

* Customized Also Available

LISTING / WARRANTY

ETL listed to US and Canadian standards for damp location W/Feed through.
3 Years Limited Warranty.



6" ULTRA-THIN GIMBAL LED RECESSED LIGHT

LIGHT SOURCE SMD CHIPS **BL6-007**



BL6-007 | Remodel



BL6-007-NC
New Construction



BL6-007-IA
IC airtight option

DESCRIPTION

This ultra thin recessed LED Panel is absolutely perfect for tight spaces, soffits and insulated and dropped ceilings. Recessed 6" Round LED Panel with integral driver in connection box. Fits where no other recessed fixture can. This LED is 12 watts and replaces a 65 watt halogen save up to 80% energy for same light output. The thin panel profile with spring clips allows for quick and easy installation. Ideal for confined spaces and suitable for damp locations.

FEATURES

Available in All 6" Round Openings
Retrofit or New Construction 1/2" Thin - Install Directly Under Joists, Maximum Layout Flexibility
Comes with Junction Box & Driver, No Housing Required Fast & Easy To Install

MOUNTING

Cut Hole In Ceiling And Snap Fixture In Opening With Attached Spring Clips. 2" Above Ceiling Clearance Required For Driver.

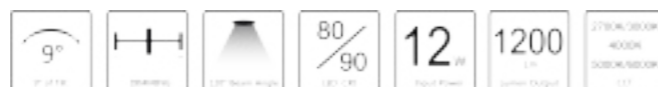

DIMENSIONS



Remodel

New Construction

※ Square and Round Items share one mounting plate of round aperture.

ORDERING GUIDE / YOUR PRODUCT CODE

SERIES	MOUNTING	TRIM	INPUT VOLTAGE	CCT	DIMMABLE	FINISH
○ BL6-007 6" Gimbal Recessed LED Panel	○ Remodel ○ New Construction ○ IC airtight	○ Trimmed ○ Trimless	○ 120V ○ 277V	○ 2700K ○ 3000K ○ 4000K ○ 5000K ○ 6000K	○ Non-Dimmable ○ Dimmable	○ White ○ Black ○ Satin Nickel

* Customized Also Available

LISTING / WARRANTY

ETL listed to US and Canadian standards for damp location W/Feed through.
3 Years Limited Warranty.

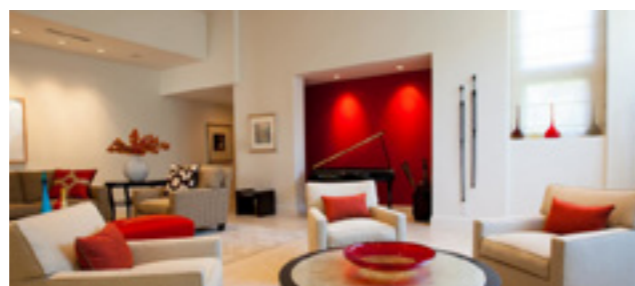

SLEEK DESIGN LED DOME LIGHT SERIES

Liteharbor LED Dome Light Series is designed to reduce targeting and improve design for better quality light. Gentle light comes out after reflected through reflector, to achieve soft lighting without seeing the light source, replaced direct lighting, like a moon hanging on the ceiling. Lights are available with LED Lighting technology and offer a stylish sleek appearance.



4" ROUND RECESSED LED DOME LIGHT

LIGHT SOURCE SMD CHIPS **BL4-401**



BL4-401 | Remodel



BL4-401-NC
New Construction

DESCRIPTION

Liteharbor Interior Dome Lights are designed to reduce targeting and improve design for better quality light. Gentle light comes out after reflected through reflector, to achieve soft lighting without seeing the light source, replaced direct lighting, like a moon hanging on the ceiling. Lights are available with LED Lighting technology and offer a stylish sleek appearance.

FEATURES

Achieve soft lighting without seeing the light source. No glare and light pollution.
Die cast aluminum body material with good heat dissipation
Higher reflection rate reflector with nano powder sprayed on surface
Use FT4 wire with high flame retardant grade independent drive junction box, easy to replace
Can be installed in 0.5" to 1.25" thick ceilings safe isolated power supply
Flicker free stable dimming, can be compatible with multi brand dimmers



DIMENSIONS

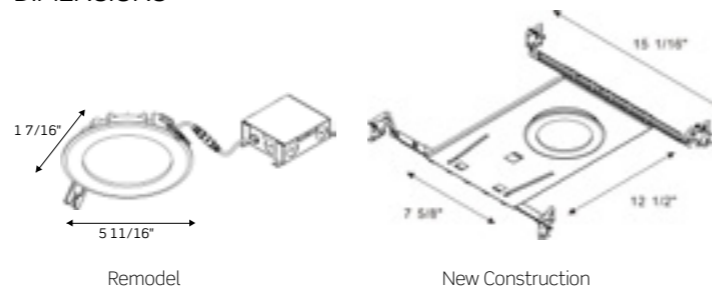

ORDERING GUIDE / YOUR PRODUCT CODE

SERIES	MOUNTING	TRIM	CCT	DIMMABLE	FINISH
○ BL4-401 4" Round Recessed LED Dome Light	○ Remodel ○ New Construction	○ Trimmed ○ Trimless	○ 2700K ○ 3000K ○ 4000K ○ 5000K ○ 6000K	○ Non-Dimmable ○ Dimmable	○ White ○ Black ○ Satin Nickel ○ Chrome

* Customized Also Available

LISTING / WARRANTY

ETL listed to US and Canadian standards for damp location W/Feed through. 3 Years Limited Warranty.



4" SQUARE RECESSED LED DOME LIGHT

LIGHT SOURCE SMD CHIPS **BL4-S401**



BL4-S401 | Remodel

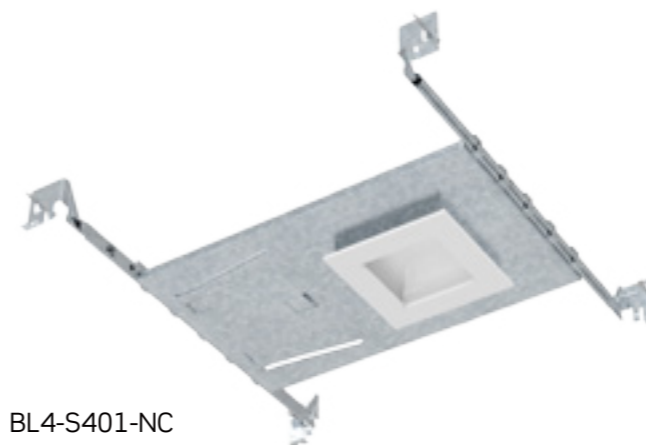

BL4-S401-NC
New Construction

※ Square and Round Items share one mounting plate of round aperture.

DESCRIPTION

Liteharbor Interior Dome Lights are designed to reduce targeting and improve design for better quality light. Gentle light comes out after reflected through reflector, to achieve soft lighting without seeing the light source, replaced direct lighting, like a moon hanging on the ceiling. Lights are available with LED Lighting technology and offer a stylish sleek appearance.

FEATURES

Achieve soft lighting without seeing the light source. No glare and light pollution.
Die cast aluminum body material with good heat dissipation
Higher reflection rate reflector with nano powder sprayed on surface
Use FT4 wire with high flame retardant grade Independent drive junction box, easy to replace
Can be installed in 0.5" to 1.25" thick ceilings safe isolated power supply
Flicker free stable dimming, can be compatible with multi brand dimmers



DIMENSIONS

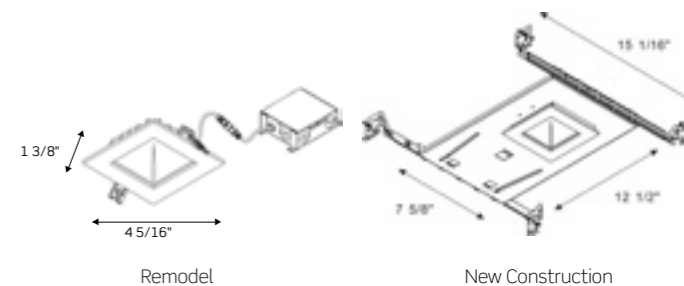

ORDERING GUIDE / YOUR PRODUCT CODE

SERIES	MOUNTING	TRIM	CCT	DIMMABLE	FINISH
○ BL4-S401 4" Square Recessed LED Dome Light	○ Remodel ○ New Construction	○ Trimmed ○ Trimless	○ 2700K ○ 3000K ○ 4000K ○ 5000K ○ 6000K	○ Non-Dimmable ○ Dimmable	○ White ○ Black ○ Satin Nickel ○ Chrome

* Customized Also Available

LISTING / WARRANTY

ETL listed to US and Canadian standards for damp location W/Feed through. 3 Years Limited Warranty.

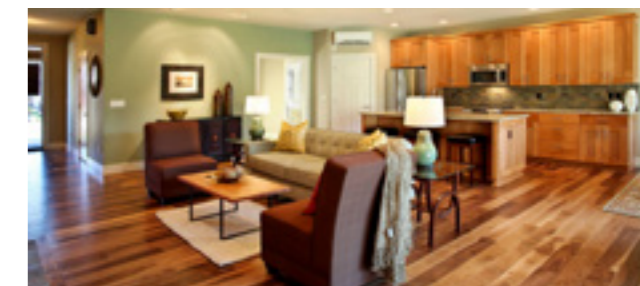

6" ROUND RECESSED LED DOME LIGHT

LIGHT SOURCE SMD CHIPS **BL6-401**



DESCRIPTION

Liteharbor Interior Dome Lights are designed to reduce targeting and improve design for better quality light. Gentle light comes out after reflected through reflector, to achieve soft lighting without seeing the light source, replaced direct lighting, like a moon hanging on the ceiling. Lights are available with LED Lighting technology and offer a stylish sleek appearance.

FEATURES

Achieve soft lighting without seeing the light source. No glare and light pollution.
 Die cast aluminum body material with good heat dissipation,
 Higher reflection rate reflector with nano powder sprayed on surface
 Use FT4 wire with high flame retardant grade Independent drive junction box, easy to replace
 Can be installed in 0.5 "to 1.25" thick ceilings safe isolated power supply
 Flicker free stable dimming, can be compatible with multi brand dimmers

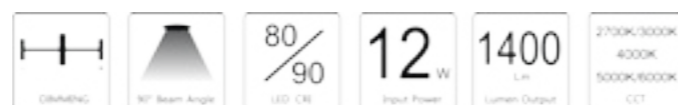

BL6-401 | Remodel



BL6-401-NC
New Construction

DIMENSIONS

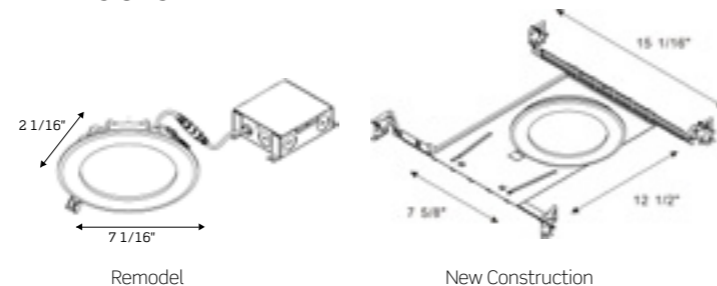

ORDERING GUIDE / YOUR PRODUCT CODE

SERIES	MOUNTING	TRIM	CCT	DIMMABLE	FINISH
<input type="radio"/> BL6-401	<input type="radio"/> Remodel	<input type="radio"/> Trimmed	<input type="radio"/> 2700K	<input type="radio"/> Non-Dimmable	<input type="radio"/> White
<input type="radio"/> 6" Round Recessed LED Dome Light	<input type="radio"/> New Construction	<input type="radio"/> Trimless	<input type="radio"/> 3000K	<input type="radio"/> Dimmable	<input type="radio"/> Black
			<input type="radio"/> 4000K		<input type="radio"/> Satin Nickel
			<input type="radio"/> 5000K		<input type="radio"/> Chrome
			<input type="radio"/> 6000K		

* Customized Also Available

LISTING / WARRANTY

ETL listed to US and Canadian standards for damp location W/Feed through. 3 Years Limited Warranty.



6" SQUARE RECESSED LED DOME LIGHT

LIGHT SOURCE SMD CHIPS **BL6-S401**



DESCRIPTION

Liteharbor Interior Dome Lights are designed to reduce targeting and improve design for better quality light. Gentle light comes out after reflected through reflector, to achieve soft lighting without seeing the light source, replaced direct lighting, like a moon hanging on the ceiling. Lights are available with LED Lighting technology and offer a stylish sleek appearance.

FEATURES

Achieve soft lighting without seeing the light source. No glare and light pollution.
 Die cast aluminum body material with good heat dissipation
 Higher reflection rate reflector with nano powder sprayed on surface
 Use FT4 wire with high flame retardant grade Independent drive junction box, easy to replace
 Can be installed in 0.5 "to 1.25" thick ceilings safe isolated power supply
 Flicker free stable dimming, can be compatible with multi brand dimmers



BL6-S401 | Remodel



BL6-S401-NC
New Construction

* Square and Round Items share one mounting plate of round aperture.

DIMENSIONS

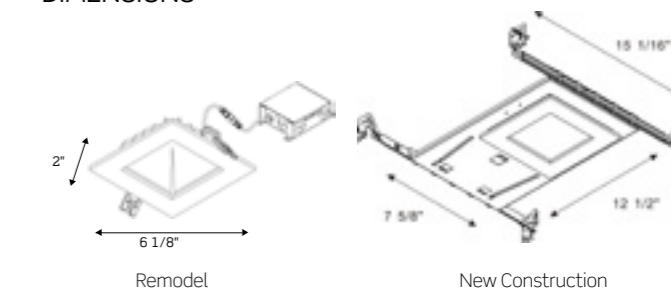

ORDERING GUIDE / YOUR PRODUCT CODE

SERIES	MOUNTING	TRIM	CCT	DIMMABLE	FINISH
<input type="radio"/> BL6-S401	<input type="radio"/> Remodel	<input type="radio"/> Trimmed	<input type="radio"/> 2700K	<input type="radio"/> Non-Dimmable	<input type="radio"/> White
<input type="radio"/> 6" Square Recessed LED Dome Light	<input type="radio"/> New Construction	<input type="radio"/> Trimless	<input type="radio"/> 3000K	<input type="radio"/> Dimmable	<input type="radio"/> Black
			<input type="radio"/> 4000K		<input type="radio"/> Satin Nickel
			<input type="radio"/> 5000K		<input type="radio"/> Chrome
			<input type="radio"/> 6000K		

* Customized Also Available

LISTING / WARRANTY

ETL listed to US and Canadian standards for damp location W/Feed through. 3 Years Limited Warranty.





ARTISTIC SENSE APPEARANCE



ARTISTIC DESIGN LED RETROFIT TRIM

Liteharbor LED Retrofit Trim Series is designed for recessed mount applications.

This LED retrofit luminaire offers a special-shaped appearance of unique artistic design. Peculiar vortex type outlet of lighting emitting, to ensure that the light is soft, avoid glare. This LED ceiling solution offers a unique irregular shape, makes a deep impression, creates an esthetic feeling for spaces.

3" ROUND RECESSED LED RETROFIT TRIM

BL3-921



BL3-921 | Remodel



BL3-921-NC
New Construction

DIMENSIONS

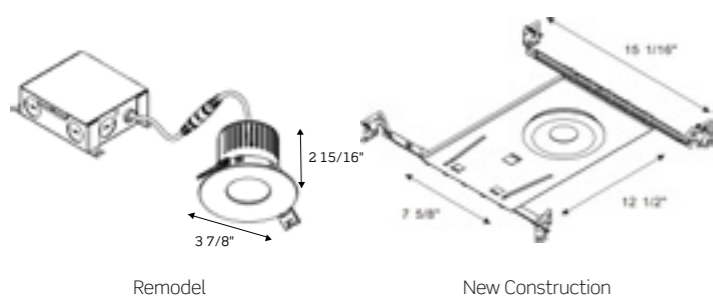

DESCRIPTION

Use cold forging radiator with good heat dissipation.
Peculiar vortex type outlet, to ensure that the light is soft, avoid glare, unique irregular shape makes an impression.
Independent power supply box, easy to maintain and replace.
Brand chip and isolated power supply, safe and reliable.
Dimming available, can be matched a variety of light regulator, dimming stability, no strobe.

FEATURES

Achieve soft lighting without seeing the light source. No glare and light pollution.
Die cast aluminum body material with good heat dissipation
Higher reflection rate reflector with nano powder sprayed on surface
Use FT4 wire with high flame retardant grade independent drive junction box, easy to replace
Can be installed in 0.5 "to 1.25" thick ceilings safe isolated power supply
Flicker free stable dimming, can be compatible with multi brand dimmers

MOUNTING CLIP OPTION

1 MOUNTING CLIPS:

- Available installed in 0.5" to 1.5" thick ceilings.
- Tool-free type easy installation, save time.

- Two Clips
- No housing required

ORDERING GUIDE / YOUR PRODUCT CODE

SERIES	MOUNTING	TRIM	CCT	DIMMABLE	FINISH
<input type="radio"/> BL3-921 3" Round Recessed LED Retrofit Trim	<input type="radio"/> Remodel <input type="radio"/> New Construction	<input type="radio"/> Trimmed <input type="radio"/> Trimless	<input type="radio"/> 2700K <input type="radio"/> 3000K <input type="radio"/> 4000K <input type="radio"/> 5000K <input type="radio"/> 6000K	<input type="radio"/> Non-Dimmable <input type="radio"/> Dimmable	<input type="radio"/> White <input type="radio"/> Black <input type="radio"/> Satin Nickel

* Customized Also Available

LISTING / WARRANTY

ETL listed to US and Canadian standards for damp location W/Feed through.
3 Years Limited Warranty.

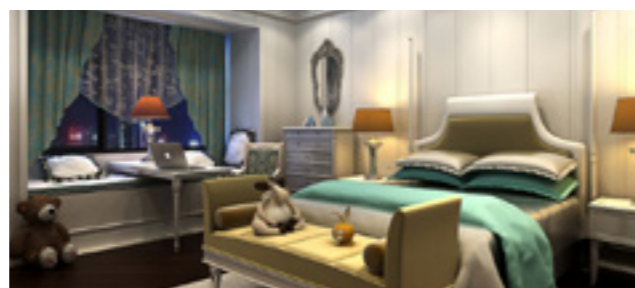

3" SQUARE RECESSED LED RETROFIT TRIM

BL3-S921



BL3-S921 | Remodel

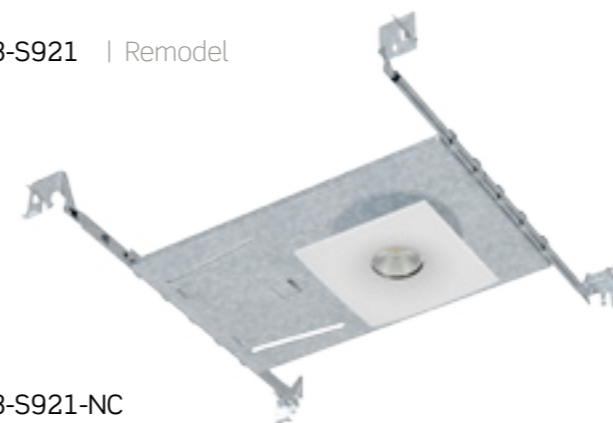

BL3-S921-NC
New Construction

DIMENSIONS

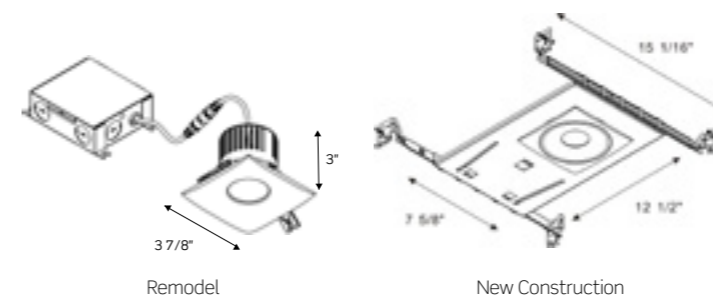

DESCRIPTION

Use cold forging radiator with good heat dissipation.
Peculiar vortex type outlet, to ensure that the light is soft, avoid glare, unique irregular shape makes an impression.
Independent power supply box, easy to maintain and replace.
Brand chip and isolated power supply, safe and reliable.
Dimming available, can be matched a variety of light regulator, dimming stability, no strobe.

FEATURES

Achieve soft lighting without seeing the light source. No glare and light pollution.
Die cast aluminum body material with good heat dissipation
Higher reflection rate reflector with nano powder sprayed on surface
Use FT4 wire with high flame retardant grade independent drive junction box, easy to replace
Can be installed in 0.5 "to 1.25" thick ceilings safe isolated power supply
Flicker free stable dimming, can be compatible with multi brand dimmers

MOUNTING CLIP OPTION

1 MOUNTING CLIPS:

- Available installed in 0.5" to 1.5" thick ceilings.
- Tool-free type easy installation, save time.

- Two Clips
- No housing required

ORDERING GUIDE / YOUR PRODUCT CODE

SERIES	MOUNTING	TRIM	CCT	DIMMABLE	FINISH
<input type="radio"/> BL3-S921 3" Square Recessed LED Retrofit Trim	<input type="radio"/> Remodel <input type="radio"/> New Construction	<input type="radio"/> Trimmed <input type="radio"/> Trimless	<input type="radio"/> 2700K <input type="radio"/> 3000K <input type="radio"/> 4000K <input type="radio"/> 5000K <input type="radio"/> 6000K	<input type="radio"/> Non-Dimmable <input type="radio"/> Dimmable	<input type="radio"/> White <input type="radio"/> Black <input type="radio"/> Satin Nickel

* Customized Also Available

LISTING / WARRANTY

ETL listed to US and Canadian standards for damp location W/Feed through.
3 Years Limited Warranty.

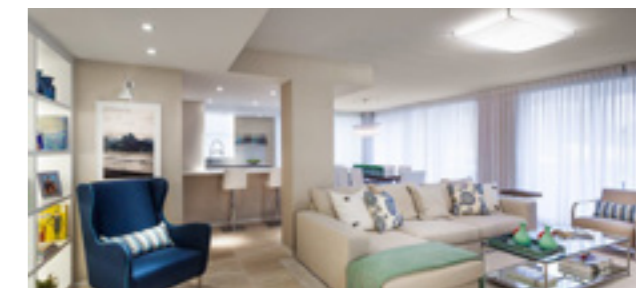

4" ROUND RECESSED LED RETROFIT TRIM

BL4-921



BL4-921 | Remodel



BL4-921-NC
New Construction

DESCRIPTION

Use cold forging radiator with good heat dissipation. Peculiar vortex type outlet, to ensure that the light is soft, avoid glare, unique irregular shape makes an impression. Independent power supply box, easy to maintain and replace. Brand chip and isolated power supply, safe and reliable. Dimming available, can be matched a variety of light regulator, dimming stability, no strobe.

FEATURES

Achieve soft lighting without seeing the light source. No glare and light pollution. Die cast aluminum body material with good heat dissipation. Higher reflection rate reflector with nano powder sprayed on surface. Use FT4 wire with high flame retardant grade independent drive junction box, easy to replace. Can be installed in 0.5" to 1.25" thick ceilings safe isolated power supply. Flicker free stable dimming, can be compatible with multi brand dimmers.

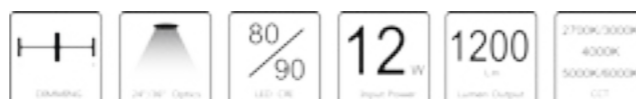

DIMENSIONS

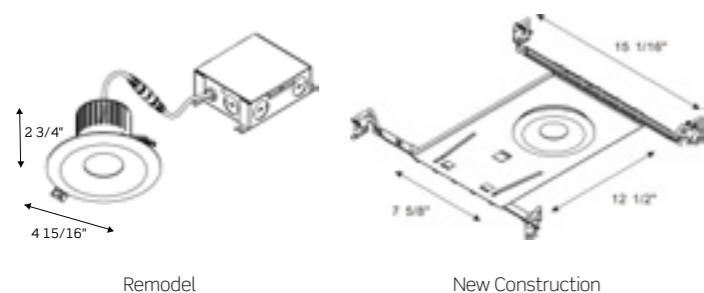

MOUNTING CLIP OPTION

1 MOUNTING CLIPS:
- Available installed in 0.5" to 1.5" thick ceilings.
- Tool-free type easy installation, save time.

- Two Clips
- No housing required

ORDERING GUIDE / YOUR PRODUCT CODE

SERIES	MOUNTING	TRIM	CCT	DIMMABLE	FINISH
BL4-921 4" Round Recessed LED Retrofit Trim	Remodel New Construction	Trimmed Trimless	2700K 3000K 4000K 5000K 6000K	Non-Dimmable Dimmable	White Black Satin Nickel

* Customized Also Available

LISTING / WARRANTY

ETL listed to US and Canadian standards for damp location W/Feed through. 3 Years Limited Warranty.

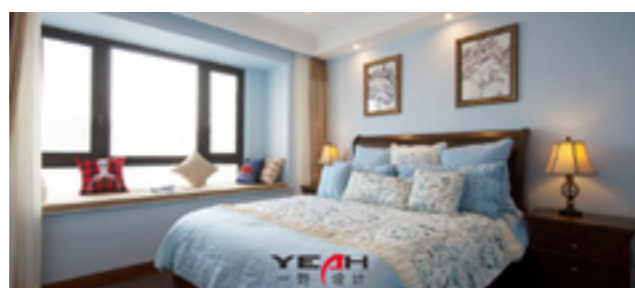

4" SQUARE RECESSED LED RETROFIT TRIM

BL4-S921



BL4-S921 | Remodel



BL4-S921-NC
New Construction

DESCRIPTION

Use cold forging radiator with good heat dissipation. Peculiar vortex type outlet, to ensure that the light is soft, avoid glare, unique irregular shape makes an impression. Independent power supply box, easy to maintain and replace. Brand chip and isolated power supply, safe and reliable. Dimming available, can be matched a variety of light regulator, dimming stability, no strobe.

FEATURES

Achieve soft lighting without seeing the light source. No glare and light pollution. Die cast aluminum body material with good heat dissipation. Higher reflection rate reflector with nano powder sprayed on surface. Use FT4 wire with high flame retardant grade independent drive junction box, easy to replace. Can be installed in 0.5" to 1.25" thick ceilings safe isolated power supply. Flicker free stable dimming, can be compatible with multi brand dimmers.



DIMENSIONS

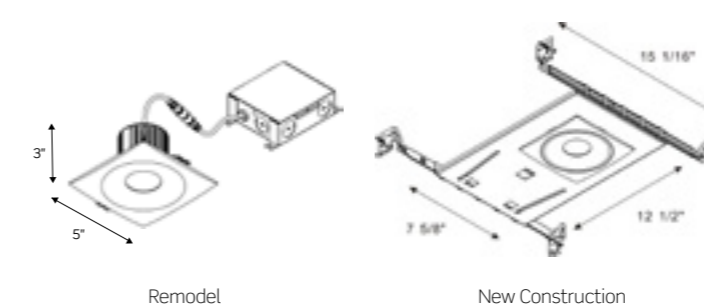

MOUNTING CLIP OPTION

1 MOUNTING CLIPS:
- Available installed in 0.5" to 1.5" thick ceilings.
- Tool-free type easy installation, save time.

- Two Clips
- No housing required

ORDERING GUIDE / YOUR PRODUCT CODE

SERIES	MOUNTING	TRIM	CCT	DIMMABLE	FINISH
BL4-S921 4" Square Recessed LED Retrofit Trim	Remodel New Construction	Trimmed Trimless	2700K 3000K 4000K 5000K 6000K	Non-Dimmable Dimmable	White Black Satin Nickel

* Customized Also Available

LISTING / WARRANTY

ETL listed to US and Canadian standards for damp location W/Feed through. 3 Years Limited Warranty.



3" SQUARE RECESSED LED RETROFIT TRIM

BL3-920-S



DESCRIPTION

Use cold forging radiator with good heat dissipation. Peculiar vortex type outlet, to ensure that the light is soft, avoid glare, unique irregular shape makes an impression. Independent power supply box, easy to maintain and replace. Brand chip and isolated power supply, safe and reliable. Dimming available, can be matched a variety of light regulator, dimming stability, no strobe.

FEATURES

Achieve soft lighting without seeing the light source. No glare and light pollution. Die cast aluminum body material with good heat dissipation. Higher reflection rate reflector with nano powder sprayed on surface. Use FT4 wire with high flame retardant grade independent drive junction box, easy to replace. Can be installed in 0.5" to 1.25" thick ceilings safe isolated power supply. Flicker free stable dimming, can be compatible with multi brand dimmers.



BL3-920-S | Remodel



BL3-921-S-NC
New Construction

DIMENSIONS

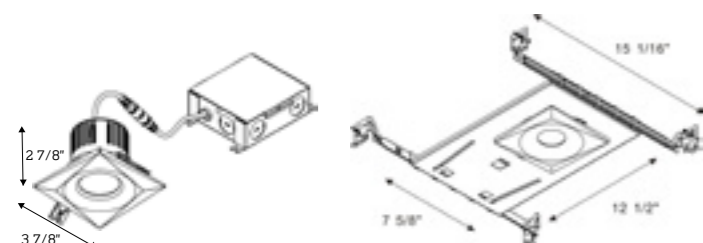

Remodel New Construction

MOUNTING CLIP OPTION



1 MOUNTING CLIPS:
- Available installed in 0.5" to 1.5" thick ceilings.
- Tool-free type easy installation, save time.

- Two Clips
- No housing required

ORDERING GUIDE / YOUR PRODUCT CODE

SERIES	MOUNTING	TRIM	CCT	DIMMABLE	FINISH
○ BL3-920-S 3" Square Recessed LED Retrofit Trim	○ Remodel ○ New Construction	○ Trimmed ○ Trimless	○ 2700K ○ 3000K ○ 4000K ○ 5000K ○ 6000K	○ Non-Dimmable ○ Dimmable	○ White ○ Black ○ Satin Nickel

* Customized Also Available

LISTING / WARRANTY

ETL listed to US and Canadian standards for damp location W/Feed through. 3 Years Limited Warranty.



4" SQUARE RECESSED LED RETROFIT TRIM

BL4-920-S



DESCRIPTION

Use cold forging radiator with good heat dissipation. Peculiar vortex type outlet, to ensure that the light is soft, avoid glare, unique irregular shape makes an impression. Independent power supply box, easy to maintain and replace. Brand chip and isolated power supply, safe and reliable. Dimming available, can be matched a variety of light regulator, dimming stability, no strobe.

FEATURES

Achieve soft lighting without seeing the light source. No glare and light pollution. Die cast aluminum body material with good heat dissipation. Higher reflection rate reflector with nano powder sprayed on surface. Use FT4 wire with high flame retardant grade independent drive junction box, easy to replace. Can be installed in 0.5" to 1.25" thick ceilings safe isolated power supply. Flicker free stable dimming, can be compatible with multi brand dimmers.

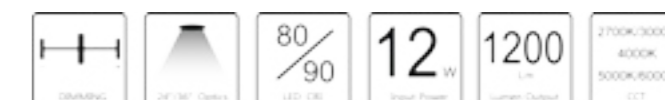

BL4-920-S | Remodel



BL4-920-S-NC
New Construction

※ Square and Round Items share one mounting plate of round aperture.

DIMENSIONS

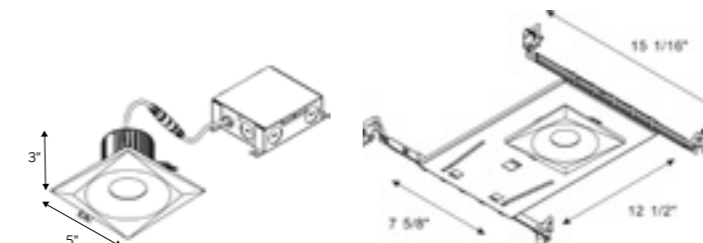

Remodel New Construction

MOUNTING CLIP OPTION



1 MOUNTING CLIPS:
- Available installed in 0.5" to 1.5" thick ceilings.
- Tool-free type easy installation, save time.

- Two Clips
- No housing required

ORDERING GUIDE / YOUR PRODUCT CODE

SERIES	MOUNTING	TRIM	CCT	DIMMABLE	FINISH
○ BL4-920-S 4" Square Recessed LED Retrofit Trim	○ Remodel ○ New Construction	○ Trimmed ○ Trimless	○ 2700K ○ 3000K ○ 4000K ○ 5000K ○ 6000K	○ Non-Dimmable ○ Dimmable	○ White ○ Black ○ Satin Nickel

* Customized Also Available

LISTING / WARRANTY

ETL listed to US and Canadian standards for damp location W/Feed through. 3 Years Limited Warranty.

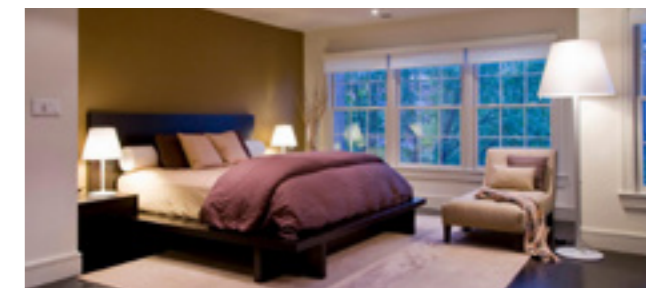



SURFACE AND SUSPENDED MOUNTED LED LINEAR WRAP LIGHT

Liteharbor LED Linear Wrap Light is a high lumen, thin, beautiful appearance, safe and reliable, convenient installation and easy maintenance linear light. It uses high transmittance pc cover and 2835 SMD LED light source. Can suitable for the commercial and industrial applications.

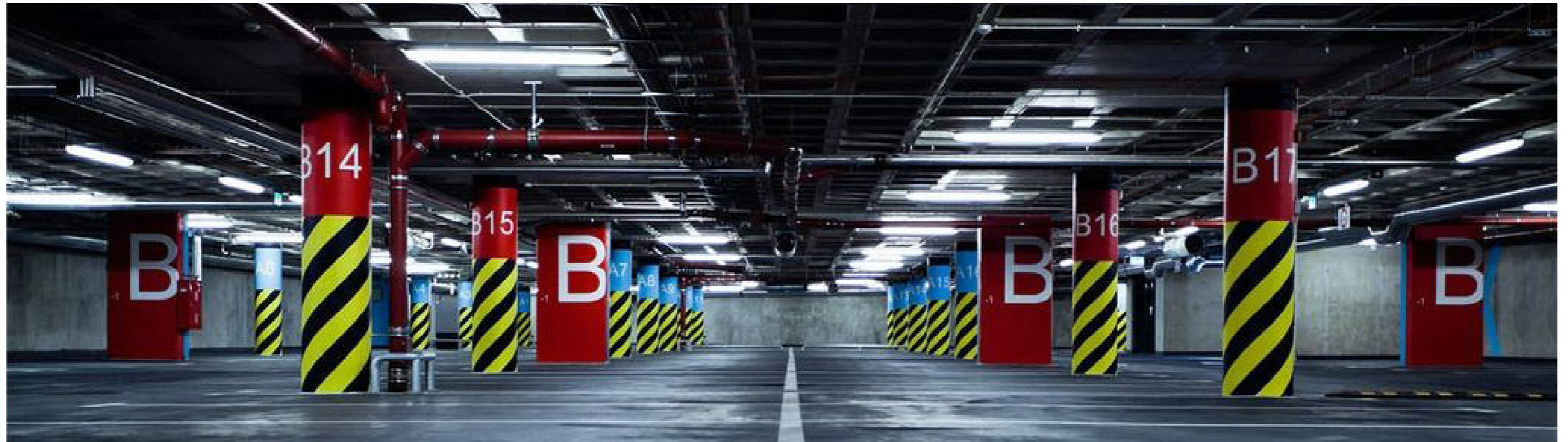

LITEHARBOR LINEAR WRAP LIGHT

What Is SMD LED?

An SMD LED (surface-mount device light-emitting diode module) is a type of LED module that uses surface-mount technology (SMT) to mount LED chips on printed circuit boards (PCB). It is a self-contained surface-mount LED device designed either to function on its own or to plug into a compatible unit.

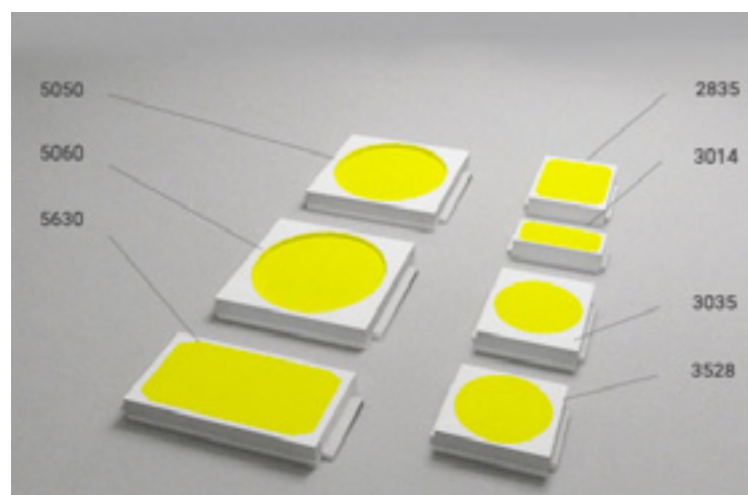

The advantage of SMD LED
 Smaller size
 More lumen output
 Better heat dissipation
 Lower lumen depreciation
 Longer life

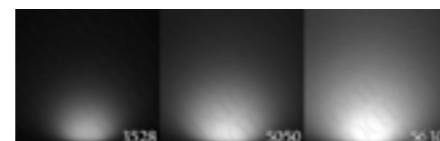

Which is the best SMD chip?

LEDs like 3528s, 5050s, 2835s and 5630s aren't really different types of chip at all - they're simply different sizes. Each has its own spec: different power requirements and output brightness. The best choice depends on what's right for your project.

WHY LINEAR LED BETTER THAN LINEAR FLUORESCENT?

Energy savings

Energy savings is perhaps the top benefit of LED lighting. A switch from linear fluorescent to linear LED could save you between 45 and 65 percent in energy costs. This is typically enough to get to a reasonable return on investment in most areas.

Long life

An average linear LED will last for around 50,000 hours, meaning it loses about 30 percent of its light output after more than 10 years. There are some value-line LED lamps that carry shorter life ratings, but you'll likely still see an improvement over the average linear fluorescent, which lasts around 20,000 hours.

Environmental impact

LED lamps contain no mercury. This is one advantage, along with low energy usage, that makes linear LED tubes the clear environmentally-friendly choice.

Easy installation and low maintenance

While linear LEDs come in many different types, the ones we typically recommend work with the existing linear fluorescent ballast. When it comes time to converting from fluorescent to LED, that makes the process pretty easy. Furthermore, the average linear fluorescent burns out much more quickly than the average linear LED lamp. As long as the ballast is in good condition, installing a newer LED will reduce your need for lighting maintenance.

Strong warranty

Today's LED manufacturers offer three-to-five-year warranties on their products, resulting in peace of mind, knowing you shouldn't have to mess with the lighting for a few years.



ADVANTAGES OF LED LINEAR LIGHTS

- Length of LED linear light can be customized from, according to different projects requirements.
- LED linear light is more flexible than big square panel lights. Various combinations can be chosen to create your idea and display effect.
- LED linear lights are the most modern lamps in office lighting, industrial lighting and home lighting.
- In Point/Line/Surface light source, LED linear lights play as an important role in lighting industry.



WHY CHOOSE LITEHARBOR LINEAR WRAP LIGHT

LITEHARBOR LIGHTING	SOME OF OTHERS
Light Transmittance	
★★★★★	★★★
Light transmittance up to 90%	Light transmittance is only 75%-80%
Light Loss	
★★★★★	★★★
Light loss is only 11%	Light loss up to 15%
LED Light Source	
★★★★★	★★★
Use of international brand light source, high efficiency and long service life.	Use of unknown brand light source, low light efficiency and short service life.
Customized Service	
★★★★★	★★
Provide variety options of size, power, installation method, structure, etc.	Customized service is unavailable, no choices of size, power, install method, structure, etc.
Application Scenario	
★★★★★	★★★
Damp rated, can meet the demand for lighting in multiple applications.	A single application scenario, it cannot meet the lighting requirements of multiple applications.
Customized Multi-Function	
★★★★★	★★
RGBW/Tunable/TRIAC dimming/0-10V dimming/Emergency Backup/Motion Sensor etc.	Only provide basic functions, it is difficult to realize the dimming and other functions.
Install And Maintain	
★★★★★	★★
Easy to install and maintain. When the power is cut off, a young lady also can maintain it without a tool.	Easy to install but it's difficult to maintain without the tools.

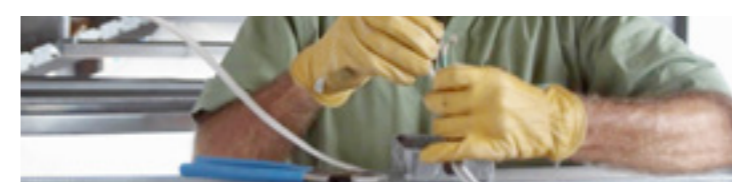
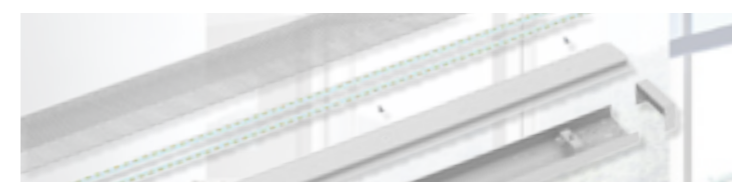
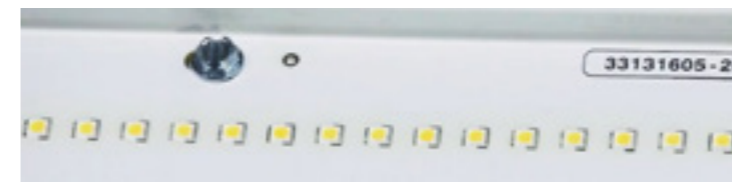
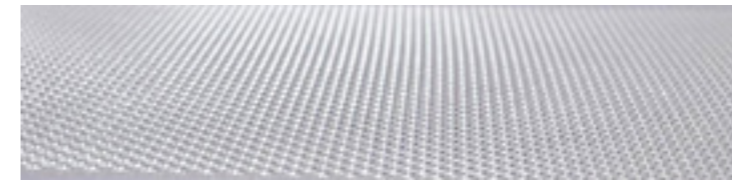

SURFACE AND SUSPENDED MOUNTED LED LINEAR WRAP LIGHT

Liteharbor LED Linear Wrap Light is a high lumen, thin, beautiful appearance, safe and reliable, convenient installation and easy maintenance linear light. It can be applied to the commercial and industrial applications.

COLOR TEMPERATURE(CCT)

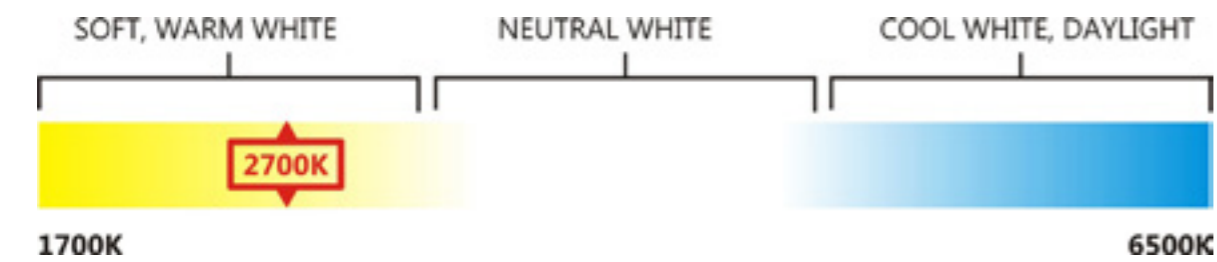

Liteharbor LED Linear Wrap Light Series are available in a wide range of color temperature, Series fixtures are available in 2700, 3000, 3500, 4000, 4500, 5000 and 6000K color temperature with a minimum 80 CRI for excellent color rendering. Optional high versions offer 90 CRI minimum.

COLOR RENDERING INDEX(CRI)

Color sample	Ra	R1	R2	R3	R4	R5	R6	R7	R8	R9	R10	R11	R12	R13	R14	R15
CRI 80+	81	80	85	89	81	78	80	86	66	16	64	79	58	81	93	75
CRI 95+	98	98	99	98	98	98	97	98	98	96	99	98	88	98	98	98
Radiant CRI 80+	81	81	86	89	81	80	80	85	68	16	66	80	62	82	93	77
Radiant CRI 95+	95	99	98	97	96	98	96	95	94	90	97	95	97	98	98	98

Color Rendering options comparison, 3000K



CRI 80+



CRI 90+

Liteharbor LED Linear Wrap Light Series are available in two CRI optional, 80+ or 90+. At the same color temperature, the effects of different CRI are different. Select the different CRI according to the applications.

MOUNTING

Luminaires may be surface mounted or suspended, individually or in continuous row. Fixtures easily snap together for long continuous rows.

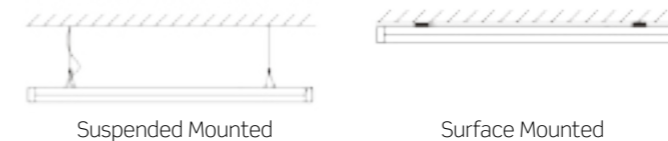

(L) OPTIONAL:

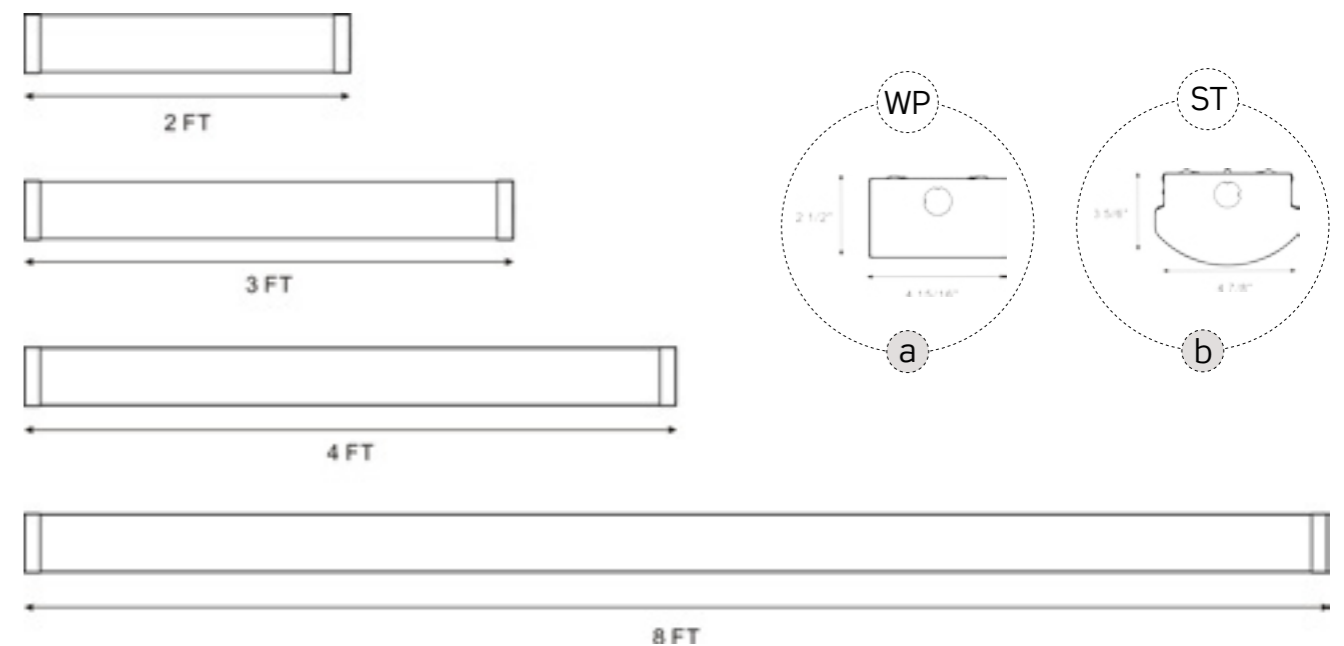

Liteharbor LED Linear Wrap Light Series offers four different lengths for you to choose, they are 2 ft, 3 ft, 4 ft and 8 ft. Select the lengths according to the applications. Customized service please confirm with our factory.

SURFACE AND SUSPENDED MOUNTED LED LINEAR WRAP LIGHT

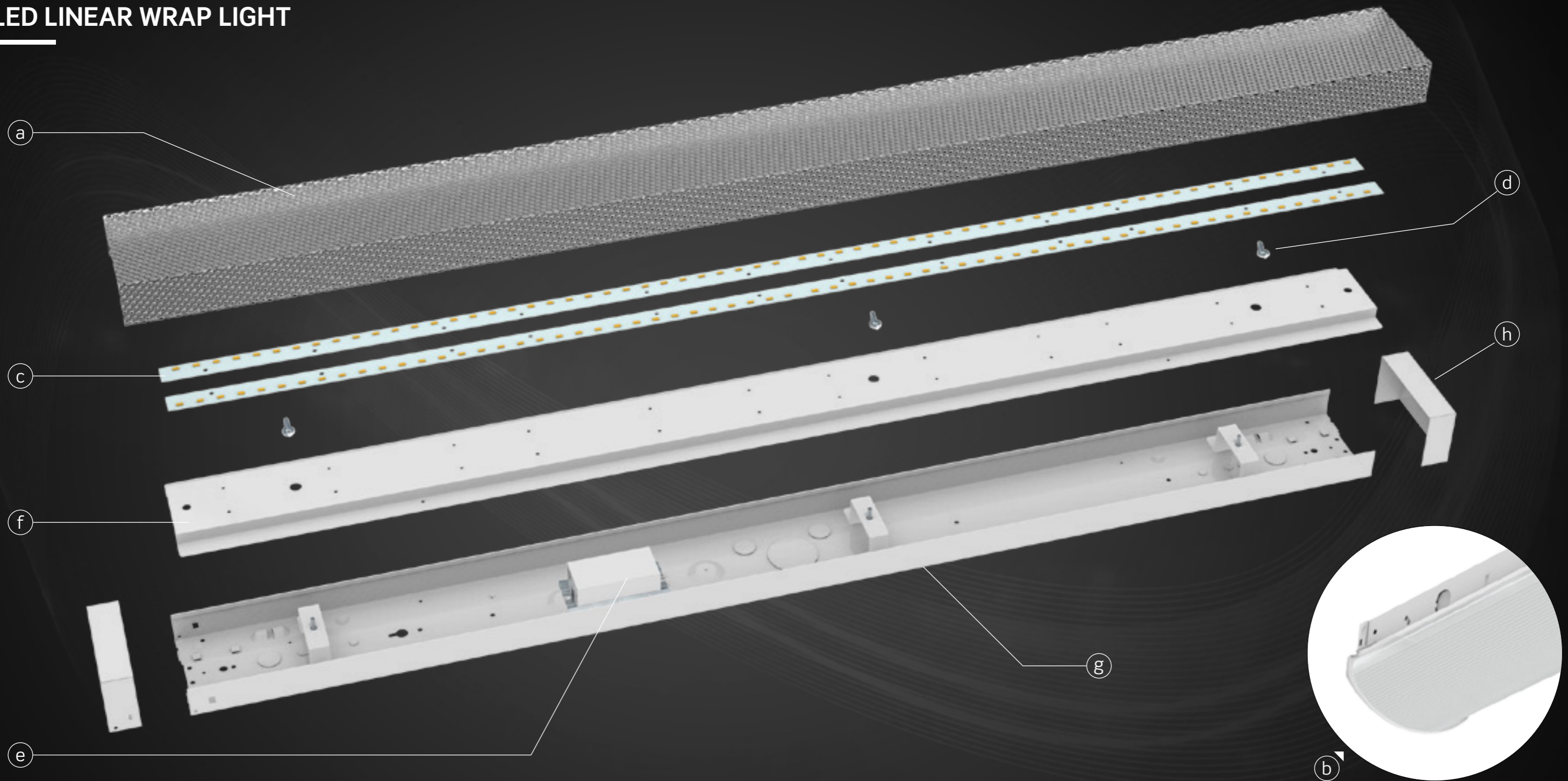

- (a) PMMA PLATE

Beautiful appearance, safe and reliable, anti-glare.
- (b) PC COVER

Imported high transmittance PC cover, retain color for a long time.
- (c) LIGHT SOURCE PLATE

2835 SMD LED light source, distributed LED array in a variety of lumen output packages.
- (d) SPRING

Stable fixed, easy to maintain
- (e) LIGHT SOURCE FASTEN PLATE

Fasten light source
- (f) DRIVER

Isolation constant-current driver power, security, stability and no flicking.
- (g) BASE PLATE

Die formed, 22 gauge cold rolled steel.
- (h) END CAP

Easy installation and maintenance, and can be used as a joint aligner for continuous row mounting.

INSTALLATION INSTRUCTIONS

LED WRAP LIGHT

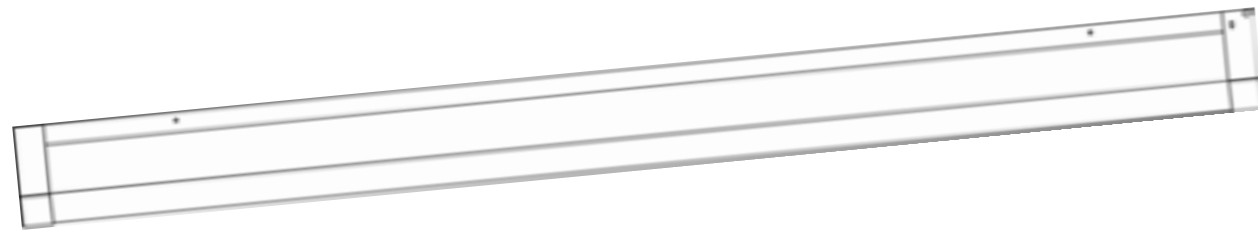

To reduce the risk of death, personal injury or property damage from fire, electric shock, falling parts, cuts/abrasions, and other hazards read all warnings and instructions included with and on the the fixture box and all fixture labels.
 Before installing, servicing, or performing routine maintenance upon this equipment, follow these general precautions.
 Commercial installation, service and maintenance of luminaires should be performed by a qualified licensed electrician.
 For Residential installation: If you are unsure about the installation or maintenance of the luminaires, consult a qualified licensed electrician and check your local electrical code.
DO NOT INSTALL DAMAGED PRODUCT!

WARNING: RISK OF ELECTRICAL SHOCK

- Turn off electrical power at fuse or circuit breaker box before wiring fixture to the power supply.
- Turn off the power when you perform any maintenance.
- Verify that supply voltage is correct by comparing it with the luminaire label information.
- Make all electrical and grounded connections in accordance with the National Electrical Code and any applicable local code requirements.
- All wiring connections should be capped with UL approved wire connectors.

CAUTION: RISK OF INJURY

- Wear gloves and safety glasses at all times when removing luminaire from carton, installing, servicing or performing maintenance.
- Avoid direct eye exposure to the light source while it is on.
- Account for small parts and destroy packing material, as these may be hazardous to children.

WARNING: RISK OF BURN

- Allow fixture to cool before handling. Do not touch enclosure or light source.
- Do not exceed maximum wattage marked on luminaire label.
- Follow all lamp manufacturer's warnings, recommendations and restrictions for: driver type, burning position, mounting locations/methods, replacement, and recycling.

WARNING: RISK OF ELECTRICAL SHOCK

- Keep combustible and other materials that can burn away from luminaire and lamp/lens.
- Minimum 90° supply conductors.

REQUIRED TOOLS

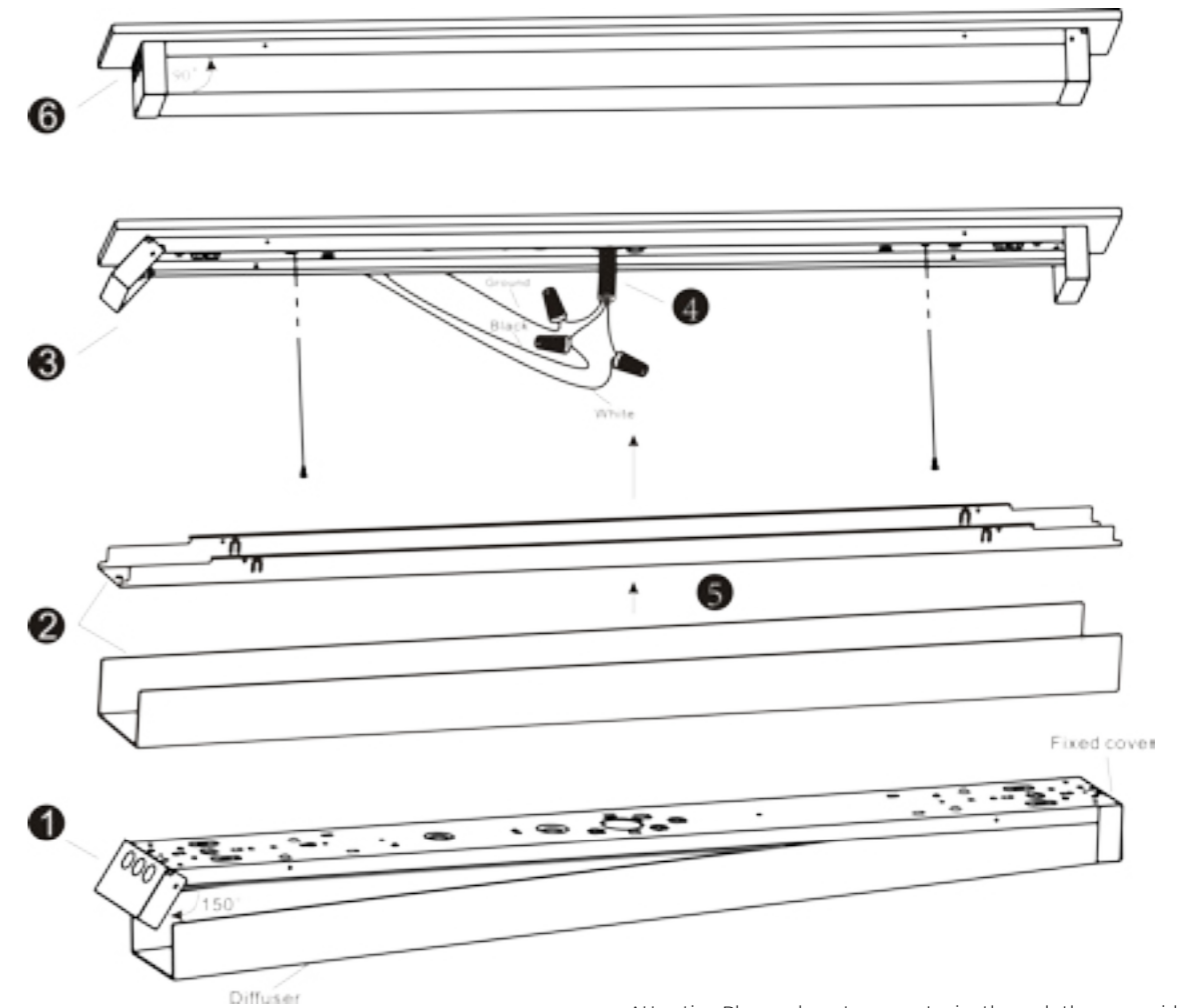

Attention: Please do not connect wire through the open side.

INSTALLATION STEPS:

1. Open the cover.(Fig. 1)
2. Remove the diffuser from the housing.
3. Press the plate and take out the plate from the housing. (Fig. 2)
4. Use the screws fix the housing to the ceiling and connect the wire, white to white, black to black and green to green.(Fig. 3 and Fig. 4.)
5. Install the plate to the housing and the lens.(Fig. 5)
6. Retato the cover marked open to 90° and installation done.(Fig. 6)
7. Installation Done.

If this fixture fails to operate properly, use the guide below to diagnose and correct the problem.

- Verify that fixture is wired properly.
- Verify that fixture is grounded correctly.
- The line voltage at the fixture is correct.

2FT SURFACE MOUNTED LED LINEAR LIGHT

LIGHT SOURCE SMD CHIPS **DGL-ST-2**



Beam Angle: 120°

Watt: 20W

Voltage: 120V ~ 277V AC

Frequency: 50/60Hz

PF: >0.9

Dimming: Non-dimming/0~10V

DESCRIPTION

Surface mounted LED wrap combines application flexibility and market leading energy efficiency and controls. The smart durable arc lens design provides smooth uniform light quality and an amazing 110 lumens per watt. The LED wrap features standard 0-10V dimming and optional occupancy sensing which delivers amazing energy savings and controllability.

FEATURES

This product is a high lumen, thin, beautiful appearance, safe and reliable, convenient installation and easy maintenance linear light. 24ga. steel frame provides strength and uniformity. Suitable for mounting in any orientation: uplight, downlight, wall, can be mounted individually or in continuous rows maximum continuous run is up to 47 luminaires at 120V and 110 luminaires at 277V. Isolated constant current drive power supply, safe and stable without stroboscopic guarantee. Standard dimming: Continuous dimming to 5% with 0-10V DC control protocol. Emergency system is available. Available in 1x2, 1x3 and 1x4 models.

SPECIFICATIONS

Light Source: Energy-saving 2835 SMD LED light source, multiple CCT optional (2700K-6500K)
LED Module: Distributed LED array in a variety of lumen output packages. Module is replaceable. Light engine delivers long life and excellent color to ensure a quality, low-maintenance.

APPLICATION

Apply to Hospitality, retail, industrial, commercial, petroleum and etc.

LISTING / WARRANTY

ETL listed to US and Canadian standards for damp location W/Feed through. 5 Year Limited Warranty.



DIMENSIONS

L : 24"
W : 4 5/16"
H : 2 9/16"



L: 2FT

PACKING

Outer Container Size: 63x24.5x16.5 cm
Inner Box Size: 115x75x620 mm

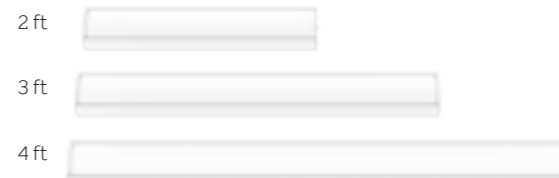

ORDERING GUIDE / YOUR PRODUCT CODE

SERIES	LUMEN	VOLTAGE	CCT	CRI	Dimming	FINISH
○ DGL-ST-2 2FT LED Linear Light	○ 2000lm	○ AC 120V ○ AC 347V ○ AC120-277V ○ AC 120-347V	○ 2700K ○ 3000K ○ 4000K ○ 5000K ○ 6500K	○ 80+ ○ 90+	○ Non-Dimming ○ 0~10V Dimming	○ White ○ Satin Nickel

* Other Special Requirement Please Contact with us

3FT SURFACE MOUNTED LED LINEAR LIGHT

LIGHT SOURCE SMD CHIPS **DGL-ST-3**



Beam Angle: 120°

Watt:30W

Voltage: 120V ~ 277V AC

Frequency: 50/60Hz

PF: >0.9

Dimming: Non-dimming/0~10V

DESCRIPTION

Surface mounted LED wrap combines application flexibility and market leading energy efficiency and controls. The smart durable arc lens design provides smooth uniform light quality and an amazing 110 lumens per watt. The LED wrap features standard 0-10V dimming and optional occupancy sensing which delivers amazing energy savings and controllability.

FEATURES

This product is a high lumen, thin, beautiful appearance, safe and reliable, convenient installation and easy maintenance linear light. 24ga. steel frame provides strength and uniformity. Suitable for mounting in any orientation: uplight, downlight, wall, can be mounted individually or in continuous rows maximum continuous run is up to 47 luminaires at 120V and 110 luminaires at 277V. Isolated constant current drive power supply, safe and stable without stroboscopic guarantee. Standard dimming: Continuous dimming to 5% with 0-10V DC control protocol. Emergency system is available. Available in 1x2, 1x3 and 1x4 models.

SPECIFICATIONS

Light Source: Energy-saving 2835 SMD LED light source, multiple CCT optional (2700K-6500K)
LED Module: Distributed LED array in a variety of lumen output packages. Module is replaceable. Light engine delivers long life and excellent color to ensure a quality, low-maintenance.

APPLICATION

Apply to Hospitality, retail, industrial, commercial, petroleum and etc.

LISTING / WARRANTY

ETL listed to US and Canadian standards for damp location W/Feed through. 5 Year Limited Warranty.



DIMENSIONS

L : 36"
W : 4 5/16"
H : 2 9/16"



L: 3FT

PACKING

Outer Container Size: 93.5x24.5x16.5 cm
Inner Box Size: 115x75x925 mm

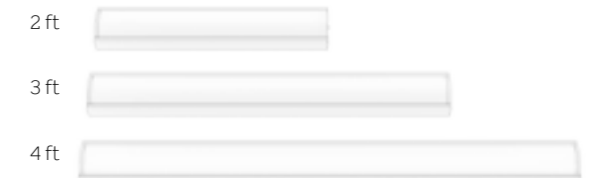

ORDERING GUIDE / YOUR PRODUCT CODE

SERIES	LUMEN	VOLTAGE	CCT	CRI	Dimming	FINISH
○ DGL-ST-3 3ft LED Linear Light	○ 3000lm	○ AC 120V ○ AC 347V ○ AC120-277V ○ AC 120-347V	○ 2700K ○ 3000K ○ 4000K ○ 5000K ○ 6500K	○ 80+ ○ 90+	○ Non-Dimming ○ 0~10V Dimming	○ White ○ Satin Nickel

* Other Special Requirement Please Contact with us

4FT SURFACE MOUNTED LED LINEAR LIGHT



Beam Angle: 120°

Watt: 40W

Voltage: 120V ~ 277V AC

Frequency: 50/60Hz

PF: >0.9

Dimming: Non-dimming/0~10V

DESCRIPTION

Surface mounted LED wrap combines application flexibility and market leading energy efficiency and controls. The smart durable arc lens design provides smooth uniform light quality and an amazing 110 lumens per watt. The LED wrap features standard 0-10V dimming and optional occupancy sensing which delivers amazing energy savings and controllability.

FEATURES

This product is a high lumen, thin, beautiful appearance, safe and reliable, convenient installation and easy maintenance linear light. 24ga. steel frame provides strength and uniformity. Suitable for mounting in any orientation: uplight, downlight, wall, can be mounted individually or in continuous rows maximum continuous run is up to 47 luminaires at 120V and 110 luminaires at 277V. Isolated constant current drive power supply, safe and stable without stroboscopic guarantee. Standard dimming: Continuous dimming to 5% with 0-10V DC control protocol. Emergency system is available. Available in 1x2, 1x3 and 1x4 models.

SPECIFICATIONS

Light Source: Energy-saving 2835 SMD LED light source, multiple CCT optional (2700K-6500K)
LED Module: Distributed LED array in a variety of lumen output packages. Module is replaceable. Light engine delivers long life and excellent color to ensure a quality, low-maintenance.

APPLICATION

Apply to Hospitality, retail, industrial, commercial, petroleum and etc.

LISTING / WARRANTY

ETL listed to US and Canadian standards for damp location W/Feed through. 5 Year Limited Warranty.



DIMENSIONS

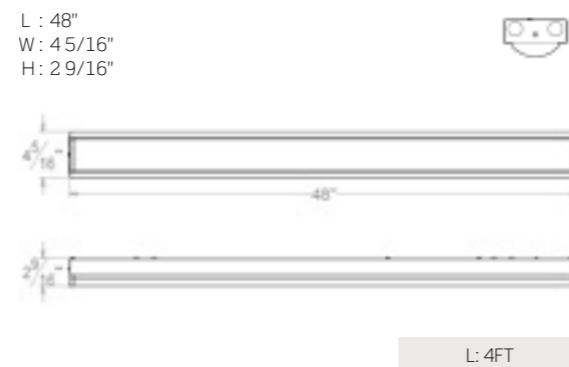

PACKING

Outer Container Size: 124.5x24.5x16.5 cm
Inner Box Size: 115x75x12.30 mm

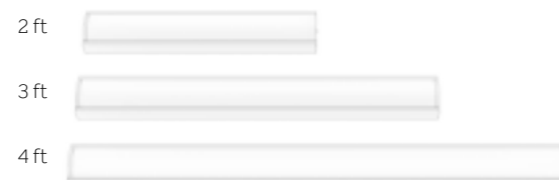

ORDERING GUIDE / YOUR PRODUCT CODE

SERIES	LUMEN	VOLTAGE	CCT	CRI	Dimming	FINISH
○ DGL-ST-4 4FT LED Linear Light	○ 4000lm	○ AC 120V ○ AC 347V ○ AC120-277V ○ AC 120-347V	○ 2700K ○ 3000K ○ 4000K ○ 5000K ○ 6500K	○ 80+ ○ 90+	○ Non-Dimming ○ 0~10V Dimming	○ White ○ Satin Nickel

* Other Special Requirement Please Contact with us

HIGH-PERFORMANCE 2X2 RECESSED LED TROFFER

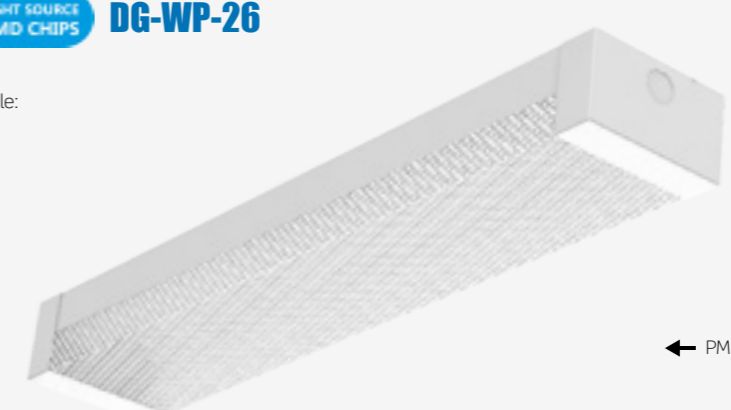

Beam Angle:
100°

Power: 20W

Voltage: 120V/277V
120V ~ 277V AC

Frequency: 50/60Hz

Power factor: >0.98

CRI: 80+/90+

Dimmable: NONE/0-10V/TRIAC

CCT: 2700-6500K

Suitable for wet locations

← PMMA Plate
Emergency system is available.

FEATURES

DG-WP-26 is a high lumen, thin, beautiful appearance, safe and reliable, convenient installation and easy maintenance linear light, is an industrial grade luminaire which is ideal for retail, commercial and industrial applications. Emergency system is available. Standard finish is powder coat textured white. Optional silver, black or custom color paint finishes.

CONSTRUCTION

Die formed, 22 gauge, cold rolled steel designed for high strength. End caps snap in for easy installation and maintenance. In addition, the end cap can be used as a joint aligner for continuous row mounting.

LIGHT SOURCE

Using the energy-saving highlighting 2835 SMD LED light source. Distributed LED array in a variety of lumen output packages. LED color is available in 2700-6500K. Module is replaceable.

DRIVER

Using isolation constant-current driver power, is the guarantee of security, stability and no flicking.

APPLICATION

suit for the garage, warehouse, basement and car parks and other places to provide general illumination.

LISTING / WARRANTY

ETL listed, conforms to UL Standard 1598 / 8750 and CSA Standard C22.2, Damp location. 5-year limited warranty on LED and Driver.



DIMENSIONS

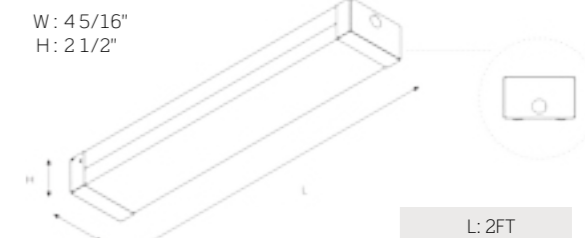

PACKING

CTN Size: 630x290x145mm (4 PCS/CTN)
Inner Box Size: 615x117x70mm

MOUNTING

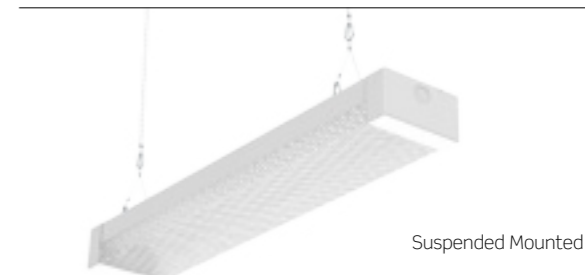

Luminaires may be surface mounted or suspended, individually or in continuous row. Fixtures easily snap together for long continuous rows.

ORDERING GUIDE / YOUR PRODUCT CODE

SERIES	VOLTAGE	WATTAGE/LUMEN	MOUNTING	FINISH	CCT	DIMMING	CUSTOMIZED FUNCTIONS
○ DG-WP-26 2FT LED Linear/ Wrap Light	○ 120V AC ○ 277V AC ○ 120-277V AC	○ 20W/1750LM	○ Surface Mounted ○ Suspended Mounted	○ White ○ Silver ○ Black	○ 2700K ○ 3000K ○ 3500K ○ 4000K ○ 5000K ○ 6000K ○ 6500K	○ NONE ○ 0-10V Dimming ○ TRIAC Dimming	○ Emergency Backup ○ RGBW ○ Tunable(3000K,4000K, 5000K,choose any 2 of them) ○ motion sensor

* Customized Also Available

HIGH-PERFORMANCE 2X4 RECESSED LED TROFFER

LIGHT SOURCE SMD CHIPS **DG-WP-36**

Beam Angle:
100°

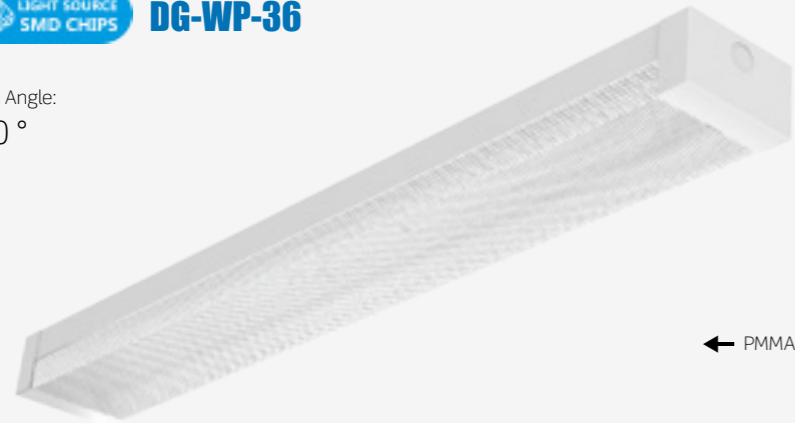

← PMMA Plate

Emergency system is available.

Power: 30W
Voltage: 120V/277V 120V ~ 277V AC
Frequency: 50/60Hz
Power factor: >0.98
CRI: 80+/90+
Dimmable: NONE/0-10V/TRIAC
CCT: 2700-6500K
Suitable for wet locations

FEATURES

DG-WP-36 is a high lumen, thin, beautiful appearance, safe and reliable, convenient installation and easy maintenance linear light, is an industrial grade luminaire which is ideal for retail, commercial and industrial applications. Emergency system is available. Standard finish is powder coat textured white. Optional silver, black or custom color paint finishes.

CONSTRUCTION

Die formed, 22 gauge, cold rolled steel designed for high strength. End caps snap in for easy installation and maintenance. In addition, the end cap can be used as a joint aligner for continuous row mounting.

LIGHT SOURCE

Using the energy-saving highlighting 2835 SMD LED light source. Distributed LED array in a variety of lumen output packages. LED color is available in 2700-6500K. Module is replaceable.

DRIVER

Using isolation constant-current driver power, is the guarantee of security, stability and no flicking.

APPLICATION

suit for the garage, warehouse, basement and car parks and other places to provide general illumination.

LISTING / WARRANTY

ETL listed, conforms to UL Standard 1598 / 8750 and CSA Standard C22.2, Damp location. 5-year limited warranty on LED and Driver.



DIMENSIONS

W : 4 5/16"
H : 2 1/2"

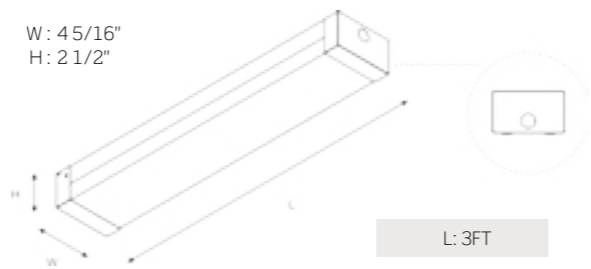

PACKING

CTN Size: 935x290x145mm (4 PCS/CTN)
Inner Box Size: 920x117x70mm

MOUNTING

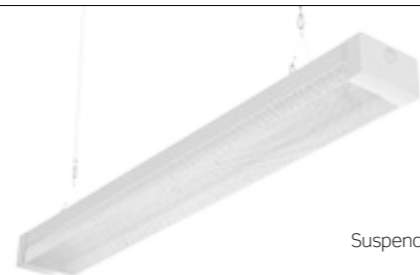

Suspended Mounted

Luminaires may be surface mounted or suspended, individually or in continuous row. Fixtures easily snap together for long continuous rows.

ORDERING GUIDE / YOUR PRODUCT CODE

SERIES	VOLTAGE	WATTAGE/LUMEN	MOUNTING	FINISH	CCT	DIMMING	CUSTOMIZED FUNCTIONS
○ DG-WP-36	○ 120V AC	○ 30W/2600LM	○ Surface Mounted	○ White	○ 2700K	○ NONE	○ Emergency Backup
○ 3FT LED Linear/ Wrap Light	○ 277V AC		○ Suspended Mounted	○ Silver	○ 3000K	○ 0-10V Dimming	○ RGBW
	○ 120-277V AC			○ Black	○ 3500K	○ TRIAC Dimming	○ Tunable(3000K,4000K, 5000K,choose any 2 of them)
					○ 4000K		○ motion sensor
					○ 5000K		
					○ 6000K		
					○ 6500K		

* Customized Also Available

HIGH-PERFORMANCE 2X2 RECESSED LED TROFFER

LIGHT SOURCE SMD CHIPS **DG-WP-46**

Beam Angle:
100°



← PMMA Plate

Emergency system is available.

Power: 40W
Voltage: 120V/277V 120V ~ 277V AC
Frequency: 50/60Hz
Power factor: >0.98
CRI: 80+/90+
Dimmable: NONE/0-10V/TRIAC
CCT: 2700-6500K
Suitable for wet locations

FEATURES

DG-WP-46 is a high lumen, thin, beautiful appearance, safe and reliable, convenient installation and easy maintenance linear light, is an industrial grade luminaire which is ideal for retail, commercial and industrial applications. Emergency system is available. Standard finish is powder coat textured white. Optional silver, black or custom color paint finishes.

CONSTRUCTION

Die formed, 22 gauge, cold rolled steel designed for high strength. End caps snap in for easy installation and maintenance. In addition, the end cap can be used as a joint aligner for continuous row mounting.

LIGHT SOURCE

Using the energy-saving highlighting 2835 SMD LED light source. Distributed LED array in a variety of lumen output packages. LED color is available in 2700-6500K. Module is replaceable.

DRIVER

Using isolation constant-current driver power, is the guarantee of security, stability and no flicking.

APPLICATION

suit for the garage, warehouse, basement and car parks and other places to provide general illumination.

LISTING / WARRANTY

ETL listed, conforms to UL Standard 1598 / 8750 and CSA Standard C22.2, Damp location. 5-year limited warranty on LED and Driver.



DIMENSIONS

W : 4 5/16"
H : 2 1/2"

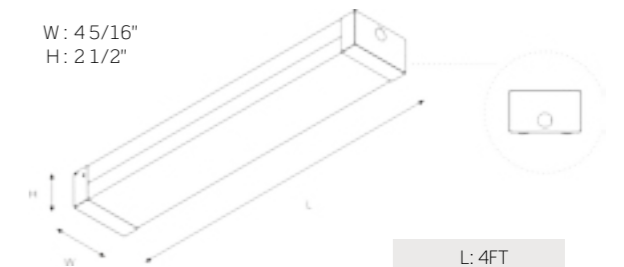

PACKING

CTN Size: 1230x290x145mm (4 PCS/CTN)
Inner Box Size: 1225x117x70mm

MOUNTING



Suspended Mounted

Luminaires may be surface mounted or suspended, individually or in continuous row. Fixtures easily snap together for long continuous rows.

ORDERING GUIDE / YOUR PRODUCT CODE

SERIES	VOLTAGE	WATTAGE/LUMEN	MOUNTING	FINISH	CCT	DIMMING	CUSTOMIZED FUNCTIONS
○ DG-WP-46	○ 120V AC	○ 40W/3500LM	○ Surface Mounted	○ White	○ 2700K	○ NONE	○ Emergency Backup
○ 4FT LED Linear/ Wrap Light	○ 277V AC		○ Suspended Mounted	○ Silver	○ 3000K	○ 0-10V Dimming	○ RGBW
	○ 120-277V AC			○ Black	○ 3500K	○ TRIAC Dimming	○ Tunable(3000K,4000K, 5000K,choose any 2 of them)
					○ 4000K		○ motion sensor
					○ 5000K		
					○ 6000K		
					○ 6500K		

* Customized Also Available

HIGH-PERFORMANCE 2X4 RECESSED LED TROFFER



Beam Angle:
100°



← PMMA Plate

Emergency system is available.

Power: 80W
Voltage: 120V/277V 120V ~ 277V AC
Frequency: 50/60Hz
Power factor: >0.98
CRI: 80+/90+
Dimmable: NONE/0-10V/TRIAC
CCT: 2700-6500K
Suitable for wet locations

FEATURES

DG-WP-86 is a high lumen, thin, beautiful appearance, safe and reliable, convenient installation and easy maintenance linear light, is an industrial grade luminaire which is ideal for retail, commercial and industrial applications. Emergency system is available. Standard finish is powder coat textured white. Optional silver, black or custom color paint finishes.

CONSTRUCTION

Die formed, 22 gauge, cold rolled steel designed for high strength. End caps snap in for easy installation and maintenance. In addition, the end cap can be used as a joint aligner for continuous row mounting.

LIGHT SOURCE

Using the energy-saving highlighting 2835 SMD LED light source. Distributed LED array in a variety of lumen output packages. LED color is available in 2700-6500K. Module is replaceable.

DRIVER

Using isolation constant-current driver power, is the guarantee of security, stability and no flicking.

APPLICATION

suit for the garage, warehouse, basement and car parks and other places to provide general illumination.

LISTING / WARRANTY

ETL listed, conforms to UL Standard 1598 / 8750 and CSA Standard C22.2, Damp location. 5-year limited warranty on LED and Driver.



DIMENSIONS

W: 4 5/16"
H: 2 1/2"

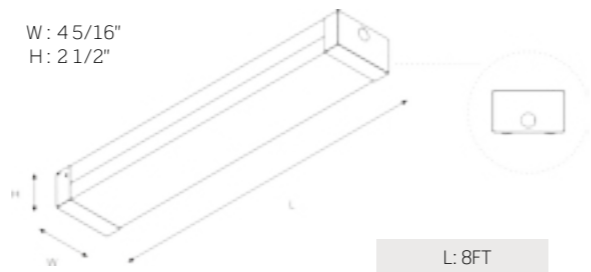

PACKING CTN Size: 2460x290x145mm (4 PCS/CTN)
Inner Box Size: 2445x117x70mm

MOUNTING



Suspended Mounted

Luminaires may be surface mounted or suspended, individually or in continuous row. Fixtures easily snap together for long continuous rows.

ORDERING GUIDE / YOUR PRODUCT CODE

SERIES	VOLTAGE	WATTAGE/LUMEN	MOUNTING	FINISH	CCT	DIMMING	CUSTOMIZED FUNCTIONS
○ DG-WP-86 8FT LED Linear/ Wrap Light	○ 120V AC	○ 80W/7000LM	○ Surface Mounted	○ White	○ 2700K ○ 3000K ○ 3500K ○ 4000K ○ 5000K ○ 6000K ○ 6500K	○ NONE	○ Emergency Backup ○ RGBW ○ Tunable(3000K,4000K,5000K,choose any 2 of them) ○ motion sensor
	○ 277V AC			○ Silver		○ 0-10V Dimming	
	○ 120-277V AC		○ Black	○ TRIAC Dimming			

* Customized Also Available

HIGH-PERFORMANCE 2X2 RECESSED LED TROFFER



Beam Angle:
100°



← PC Cover

Emergency system is available.

Power: 20W
Voltage: 120V/277V 120V ~ 277V AC
Frequency: 50/60Hz
Power factor: >0.98
CRI: 80+/90+
Dimmable: NONE/0-10V/TRIAC
CCT: 2700-6500K
Suitable for wet locations

FEATURES

DG-ST-2 is a high lumen, thin, beautiful appearance, safe and reliable, convenient installation and easy maintenance linear light, is an industrial grade luminaire which is ideal for retail, commercial and industrial applications. Using imported high transmittance pc cover, retain color for long time. Emergency system is available. Standard finish is powder coat textured white. Optional silver, black or custom color paint finishes.

CONSTRUCTION

Die formed, 22 gauge, cold rolled steel designed for high strength. End caps snap in for easy installation and maintenance. In addition, the end cap can be used as a joint aligner for continuous row mounting.

LIGHT SOURCE

Using the energy-saving highlighting 2835 SMD LED light source. Distributed LED array in a variety of lumen output packages. LED color is available in 2700-6500K. Module is replaceable.

DRIVER

Using isolation constant-current driver power, is the guarantee of security, stability and no flicking.

APPLICATION

suit for the garage, warehouse, basement and car parks and other places to provide general illumination.

LISTING / WARRANTY

ETL listed, conforms to UL Standard 1598 / 8750 and CSA Standard C22.2, Damp location. 5-year limited warranty on LED and Driver.



DIMENSIONS

W: 4 7/8"
H: 3 5/6"



PACKING CTN Size: 630x420x155mm (4 PCS/CTN)
Inner Box Size: 615x130x100mm

MOUNTING



Suspended Mounted

Luminaires may be surface mounted or suspended, individually or in continuous row. Fixtures easily snap together for long continuous rows.

ORDERING GUIDE / YOUR PRODUCT CODE

SERIES	VOLTAGE	WATTAGE/LUMEN	MOUNTING	FINISH	CCT	DIMMING	CUSTOMIZED FUNCTIONS
○ DG-ST-2 2FT LED Linear/ Wrap Light	○ 120V AC	○ 20W/1750LM	○ Surface Mounted	○ White	○ 2700K ○ 3000K ○ 3500K ○ 4000K ○ 5000K ○ 6000K ○ 6500K	○ NONE	○ Emergency Backup ○ RGBW ○ Tunable(3000K,4000K,5000K,choose any 2 of them) ○ motion sensor
	○ 277V AC			○ Silver		○ 0-10V Dimming	
	○ 120-277V AC		○ Black	○ TRIAC Dimming			

* Customized Also Available

HIGH-PERFORMANCE 2X4 RECESSED LED TROFFER



Beam Angle:
100°

← PC Cover

Emergency system is available.

Power: 30W

Voltage: 120V/277V
120V ~ 277V AC

Frequency: 50/60Hz

Power factor: >0.98

CRI: 80+/90+

Dimmable: NONE/0-10V/TRIAC

CCT: 2700-6500K

Suitable for wet locations

FEATURES

DG-ST-3 is a high lumen, thin, beautiful appearance, safe and reliable, convenient installation and easy maintenance linear light, is an industrial grade luminaire which is ideal for retail, commercial and industrial applications. Using imported high transmittance pc cover, retain color for long time. Emergency system is available. Standard finish is powder coat textured white. Optional silver, black or custom color paint finishes.

CONSTRUCTION

Die formed, 22 gauge, cold rolled steel designed for high strength. End caps snap in for easy installation and maintenance. In addition, the end cap can be used as a joint aligner for continuous row mounting.

LIGHT SOURCE

Using the energy-saving highlighting 2835 SMD LED light source. Distributed LED array in a variety of lumen output packages. LED color is available in 2700-6500K. Module is replaceable.

DRIVER

Using isolation constant-current driver power, is the guarantee of security, stability and no flicking.

APPLICATION

suit for the garage, warehouse, basement and car parks and other places to provide general illumination.

LISTING / WARRANTY

ETL listed, conforms to UL Standard 1598 / 8750 and CSA Standard C22.2, Damp location. 5-year limited warranty on LED and Driver.



DIMENSIONS

W : 4 7/8"
H : 3 5/8"



PACKING CTN Size: 935x420x155mm (4 PCS/CTN)
Inner Box Size: 920x130x100mm

MOUNTING



Luminaires may be surface mounted or suspended, individually or in continuous row. Fixtures easily snap together for long continuous rows.

ORDERING GUIDE / YOUR PRODUCT CODE

SERIES	VOLTAGE	WATTAGE/LUMEN	MOUNTING	FINISH	CCT	DIMMING	CUSTOMIZED FUNCTIONS
○ DG-ST-3	○ 120V AC	○ 30W/2600LM	○ Surface Mounted	○ White	○ 2700K	○ NONE	○ Emergency Backup
○ 3FT LED Linear/ Wrap Light	○ 277V AC		○ Suspended Mounted	○ Silver	○ 3000K	○ 0-10V Dimming	○ RGBW
	○ 120-277V AC			○ Black	○ 3500K	○ TRIAC Dimming	○ Tunable(3000K,4000K, 5000K,choose any 2 of them)
					○ 4000K		○ motion sensor
					○ 5000K		
					○ 6000K		
					○ 6500K		

* Customized Also Available

HIGH-PERFORMANCE 2X2 RECESSED LED TROFFER



Beam Angle:
100°

← PC Cover

Emergency system is available.

Power: 40W

Voltage: 120V/277V
120V ~ 277V AC

Frequency: 50/60Hz

Power factor: >0.98

CRI: 80+/90+

Dimmable: NONE/0-10V/TRIAC

CCT: 2700-6500K

Suitable for wet locations

FEATURES

DG-ST-4 is a high lumen, thin, beautiful appearance, safe and reliable, convenient installation and easy maintenance linear light, is an industrial grade luminaire which is ideal for retail, commercial and industrial applications. Using imported high transmittance pc cover, retain color for long time. Emergency system is available. Standard finish is powder coat textured white. Optional silver, black or custom color paint finishes.

CONSTRUCTION

Die formed, 22 gauge, cold rolled steel designed for high strength. End caps snap in for easy installation and maintenance. In addition, the end cap can be used as a joint aligner for continuous row mounting.

LIGHT SOURCE

Using the energy-saving highlighting 2835 SMD LED light source. Distributed LED array in a variety of lumen output packages. LED color is available in 2700-6500K. Module is replaceable.

DRIVER

Using isolation constant-current driver power, is the guarantee of security, stability and no flicking.

APPLICATION

suit for the garage, warehouse, basement and car parks and other places to provide general illumination.

LISTING / WARRANTY

ETL listed, conforms to UL Standard 1598 / 8750 and CSA Standard C22.2, Damp location. 5-year limited warranty on LED and Driver.



DIMENSIONS

W : 4 7/8"
H : 3 5/8"



PACKING CTN Size: 1240x420x155mm (4 PCS/CTN)
Inner Box Size: 1225x130x100mm

MOUNTING



Luminaires may be surface mounted or suspended, individually or in continuous row. Fixtures easily snap together for long continuous rows.

ORDERING GUIDE / YOUR PRODUCT CODE

SERIES	VOLTAGE	WATTAGE/LUMEN	MOUNTING	FINISH	CCT	DIMMING	CUSTOMIZED FUNCTIONS
○ DG-ST-4	○ 120V AC	○ 40W/3500LM	○ Surface Mounted	○ White	○ 2700K	○ NONE	○ Emergency Backup
○ 4FT LED Linear/ Wrap Light	○ 277V AC		○ Suspended Mounted	○ Silver	○ 3000K	○ 0-10V Dimming	○ RGBW
	○ 120-277V AC			○ Black	○ 3500K	○ TRIAC Dimming	○ Tunable(3000K,4000K, 5000K,choose any 2 of them)
					○ 4000K		○ motion sensor
					○ 5000K		
					○ 6000K		
					○ 6500K		

* Customized Also Available

HIGH-PERFORMANCE 2X4 RECESSED LED TROFFER



DG-ST-8

Beam Angle:
100°



← PC Cover

Emergency system is available.

Power: 80W
Voltage: 120V/277V 120V ~ 277V AC
Frequency: 50/60Hz
Power factor: >0.98
CRI: 80+/90+
Dimmable: NONE/0-10V/TRIAC
CCT: 2700-6500K
suitable for damp locations

FEATURES

DG-ST-8 is a high lumen, thin, beautiful appearance, safe and reliable, convenient installation and easy maintenance linear light, is an industrial grade luminaire which is ideal for retail, commercial and industrial applications. Using imported high transmittance pc cover, retain color for long time. Emergency system is available. Standard finish is powder coat textured white. Optional silver, black or custom color paint finishes.

CONSTRUCTION

Die formed, 22 gauge, cold rolled steel designed for high strength. End caps snap in for easy installation and maintenance. In addition, the end cap can be used as a joint aligner for continuous row mounting.

LIGHT SOURCE

Using the energy-saving highlighting 2835 SMD LED light source. Distributed LED array in a variety of lumen output packages. LED color is available in 2700-6500K. Module is replaceable.

DRIVER

Using isolation constant-current driver power, is the guarantee of security, stability and no flicking.

APPLICATION

suit for the garage, warehouse, basement and car parks and other places to provide general illumination.

LISTING / WARRANTY

ETL listed, conforms to UL Standard 1598 / 8750 and CSA Standard C22.2, Damp location. 5-year limited warranty on LED and Driver.



DIMENSIONS

W : 4 7/8"
H : 3 5/6"

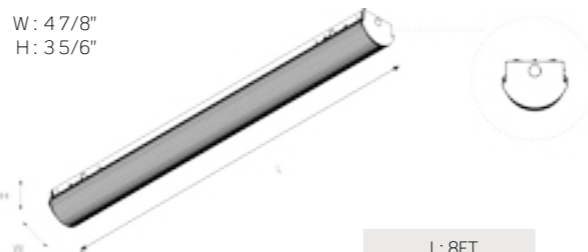

L: 8FT

PACKING

CTN Size: 2460x420x155mm (4 PCS/CTN)
Inner Box Size: 2445x130x100mm

MOUNTING



Suspended Mounted

Luminaires may be surface mounted or suspended, individually or in continuous row. Fixtures easily snap together for long continuous rows.

ORDERING GUIDE / YOUR PRODUCT CODE

SERIES	VOLTAGE	WATTAGE/LUMEN	MOUNTING	FINISH	CCT	DIMMING	CUSTOMIZED FUNCTIONS
○ DG-ST-8 8FT LED Linear/ Wrap Light	○ 120V AC ○ 277V AC ○ 120-277V AC	○ 80W/7000LM	○ Surface Mounted ○ Suspended Mounted	○ White ○ Silver ○ Black	○ 2700K ○ 3000K ○ 3500K ○ 4000K ○ 5000K ○ 6000K ○ 6500K	○ NONE ○ 0-10V Dimming ○ TRIAC Dimming	○ Emergency Backup ○ RGBW ○ Tunable(3000K,4000K, 5000K,choose any 2 of them) ○ motion sensor

* Customized Also Available

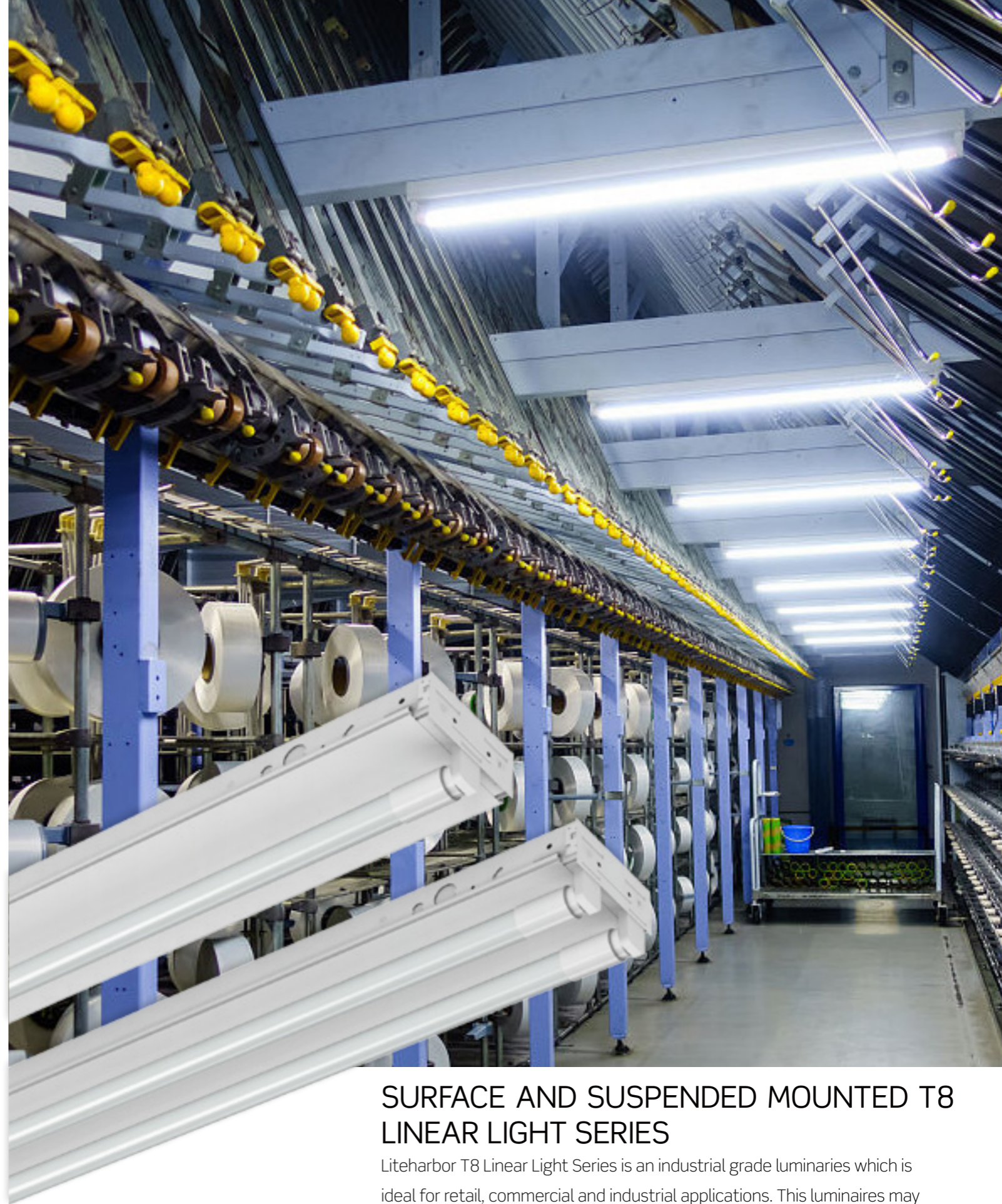

SURFACE AND SUSPENDED MOUNTED T8 LINEAR LIGHT SERIES

Liteharbor T8 Linear Light Series is an industrial grade luminaires which is ideal for retail, commercial and industrial applications. This luminaires may be surface mounted or suspended, individually or in continuous row. Fixtures easily snap together for long continuous rows.

HIGH-PERFORMANCE 2X2 RECESSED LED TROFFER



Light Source is not included



Beam Angle: 100°

Power: 9W/Tube
Voltage: 120V ~ 277V AC
Frequency: 50/60Hz
CRI: 80+/90+
CCT: 2700-6500K

FEATURES

The product is a single tube or double tube T8 LED tube, providing high lumen, thin, elegant in appearance, safe and reliable, easy to install and maintenance linear Light. This series product is an industrial grade luminaires which is ideal for retail, commercial and industrial applications. Standard finish is powder coat textured white. Optional silver, black or custom color paint finishes.

CONSTRUCTION

Die formed, 22 gauge, cold rolled steel designed for high strength.

END CAPS

End caps snap in for easy installation and maintenance. In addition, the end cap can be used as a joint aligner for continuous row mounting.

FINISH

White polyester polymer with high reflectivity. Optional silver, black or custom color paint finishes.

MOUNTING

Surface or suspension mount, individually or in continuous rows. Sufficient knockouts are provided.

APPLICATION

Suit for the garage, warehouse, basement and car parks and other places to provide general illumination.

LISTING / WARRANTY

ETL listed
5-year limited warranty on LED and Driver.



DIMENSIONS

W: 4 13/16"
H: 2 7/8"



PACKING

CTN Size: 630x240x150mm (4 PCS/CTN)
Inner Box Size: 615x125x55mm

MOUNTING



Suspended Mounted

Luminaires may be surface mounted or suspended, individually or in continuous row. Fixtures easily snap together for long continuous rows.

ORDERING GUIDE / YOUR PRODUCT CODE

SERIES	VOLTAGE	MOUNTING	FINISH
<input type="radio"/> DGL-2WT81 LED T8 Linear Wrap Light	<input type="radio"/> 120V ~ 277V AC	<input type="radio"/> Surface Mounted <input type="radio"/> Suspended Mounted	<input type="radio"/> White <input type="radio"/> Silver <input type="radio"/> Black

* Foot Single Tube

HIGH-PERFORMANCE 2X4 RECESSED LED TROFFER



Light Source is not included



Beam Angle: 100°

Power: 9W/Tube
Voltage: 120V ~ 277V AC
Frequency: 50/60Hz
CRI: 80+/90+
CCT: 2700-6500K

FEATURES

The product is a single tube or double tube T8 LED tube, providing high lumen, thin, elegant in appearance, safe and reliable, easy to install and maintenance linear Light. This series product is an industrial grade luminaires which is ideal for retail, commercial and industrial applications. Standard finish is powder coat textured white. Optional silver, black or custom color paint finishes.

CONSTRUCTION

Die formed, 22 gauge, cold rolled steel designed for high strength.

END CAPS

End caps snap in for easy installation and maintenance. In addition, the end cap can be used as a joint aligner for continuous row mounting.

FINISH

White polyester polymer with high reflectivity. Optional silver, black or custom color paint finishes.

MOUNTING

Surface or suspension mount, individually or in continuous rows. Sufficient knockouts are provided.

APPLICATION

Suit for the garage, warehouse, basement and car parks and other places to provide general illumination.

LISTING / WARRANTY

ETL listed
5-year limited warranty on LED and Driver.



DIMENSIONS

W: 4 13/16"
H: 2 7/8"



PACKING

CTN Size: 630x240x150mm (4 PCS/CTN)
Inner Box Size: 615x125x55mm

MOUNTING



Suspended Mounted

Luminaires may be surface mounted or suspended, individually or in continuous row. Fixtures easily snap together for long continuous rows.

ORDERING GUIDE / YOUR PRODUCT CODE

SERIES	VOLTAGE	MOUNTING	FINISH
<input type="radio"/> DGL-2WT82 LED T8 Linear Wrap Light	<input type="radio"/> 120V ~ 277V AC	<input type="radio"/> Surface Mounted <input type="radio"/> Suspended Mounted	<input type="radio"/> White <input type="radio"/> Silver <input type="radio"/> Black

* Foot Double Tube

HIGH-PERFORMANCE 2X2 RECESSED LED TROFFER



Light Source is not included



Beam Angle: 100°

Power: 13W/Tube
Voltage: 120V ~ 277V AC
Frequency: 50/60Hz
CRI: 80+ /90+
CCT: 2700-6500K

FEATURES

The product is a single tube or double tube T8 LED tube, providing high lumen, thin, elegant in appearance, safe and reliable, easy to install and maintenance linear Light. This series product is an industrial grade luminaries which is ideal for retail, commercial and industrial applications. Standard finish is powder coat textured white. Optional silver, black or custom color paint finishes.

CONSTRUCTION

Die formed, 22 gauge, cold rolled steel designed for high strength.

END CAPS

End caps snap in for easy installation and maintenance. In addition, the end cap can be used as a joint aligner for continuous row mounting.

FINISH

White polyester polymer with high reflectivity. Optional silver, black or custom color paint finishes.

MOUNTING

Surface or suspension mount, individually or in continuous rows. Sufficient knockouts are provided.

APPLICATION

Suit for the garage, warehouse, basement and car parks and other places to provide general illumination.

LISTING / WARRANTY

ETL listed
5-year limited warranty on LED and Driver.



DIMENSIONS

W: 4 13/16"
H: 2 7/8"



PACKING CTN Size: 935x240x150mm (4 PCS/CTN)
Inner Box Size: 920x125x55mm

MOUNTING



Suspended Mounted

Luminaires may be surface mounted or suspended, individually or in continuous row. Fixtures easily snap together for long continuous rows.

ORDERING GUIDE / YOUR PRODUCT CODE

SERIES	VOLTAGE	MOUNTING	FINISH
○ DGL-3WT81 LED T8 Linear Wrap Light	○ 120V ~ 277V AC	○ Surface Mounted ○ Suspended Mounted	○ White ○ Silver ○ Black

* Foot Single Tube

HIGH-PERFORMANCE 2X4 RECESSED LED TROFFER



Light Source is not included



Beam Angle: 100°

Power: 13W/Tube
Voltage: 120V ~ 277V AC
Frequency: 50/60Hz
CRI: 80+ /90+
CCT: 2700-6500K

FEATURES

The product is a single tube or double tube T8 LED tube, providing high lumen, thin, elegant in appearance, safe and reliable, easy to install and maintenance linear Light. This series product is an industrial grade luminaries which is ideal for retail, commercial and industrial applications. Standard finish is powder coat textured white. Optional silver, black or custom color paint finishes.

CONSTRUCTION

Die formed, 22 gauge, cold rolled steel designed for high strength.

END CAPS

End caps snap in for easy installation and maintenance. In addition, the end cap can be used as a joint aligner for continuous row mounting.

FINISH

White polyester polymer with high reflectivity. Optional silver, black or custom color paint finishes.

MOUNTING

Surface or suspension mount, individually or in continuous rows. Sufficient knockouts are provided.

APPLICATION

Suit for the garage, warehouse, basement and car parks and other places to provide general illumination.

LISTING / WARRANTY

ETL listed
5-year limited warranty on LED and Driver.



DIMENSIONS

W: 4 13/16"
H: 2 7/8"



PACKING CTN Size: 935x240x150mm (4 PCS/CTN)
Inner Box Size: 920x125x55mm

MOUNTING



Suspended Mounted

Luminaires may be surface mounted or suspended, individually or in continuous row. Fixtures easily snap together for long continuous rows.

ORDERING GUIDE / YOUR PRODUCT CODE

SERIES	VOLTAGE	MOUNTING	FINISH
○ DGL-3WT82 LED T8 Linear Wrap Light	○ 120V ~ 277V AC	○ Surface Mounted ○ Suspended Mounted	○ White ○ Silver ○ Black

* Foot Double Tube

HIGH-PERFORMANCE 2X2 RECESSED LED TROFFER



Light Source is not included



Beam Angle: 100°

Power: 18W/Tube

Voltage: 120V ~ 277V AC

Frequency: 50/60Hz

CRI: 80+/90+

CCT: 2700-6500K

FEATURES

The product is a single tube or double tube T8 LED tube, providing high lumen, thin, elegant in appearance, safe and reliable, easy to install and maintenance linear Light. This series product is an industrial grade luminaries which is ideal for retail, commercial and industrial applications. Standard finish is powder coat textured white. Optional silver, black or custom color paint finishes.

CONSTRUCTION

Die formed, 22 gauge, cold rolled steel designed for high strength.

END CAPS

End caps snap in for easy installation and maintenance. In addition, the end cap can be used as a joint aligner for continuous row mounting.

FINISH

White polyester polymer with high reflectivity. Optional silver, black or custom color paint finishes.

MOUNTING

Surface or suspension mount, individually or in continuous rows. Sufficient knockouts are provided.

APPLICATION

Suit for the garage, warehouse, basement and car parks and other places to provide general illumination.

LISTING / WARRANTY

ETL listed
5-year limited warranty on LED and Driver.



DIMENSIONS

W: 4 13/16"
H: 2 7/8"



L: 4FT

PACKING

CTN Size: 1230x240x145mm (4 PCS/CTN)
Inner Box Size: 1225x125x55mm

MOUNTING



Suspended Mounted

Luminaires may be surface mounted or suspended, individually or in continuous row. Fixtures easily snap together for long continuous rows.

ORDERING GUIDE / YOUR PRODUCT CODE



SERIES	VOLTAGE	MOUNTING	FINISH
<input type="radio"/> DGL-4WT81 LED T8 Linear Wrap Light	<input type="radio"/> 120V ~ 277V AC	<input type="radio"/> Surface Mounted <input type="radio"/> Suspended Mounted	<input type="radio"/> White <input type="radio"/> Silver <input type="radio"/> Black

* Foot Single Tube

HIGH-PERFORMANCE 2X4 RECESSED LED TROFFER



Light Source is not included



Beam Angle: 100°

Power: 18W/Tube

Voltage: 120V ~ 277V AC

Frequency: 50/60Hz

CRI: 80+/90+

CCT: 2700-6500K

FEATURES

The product is a single tube or double tube T8 LED tube, providing high lumen, thin, elegant in appearance, safe and reliable, easy to install and maintenance linear Light. This series product is an industrial grade luminaries which is ideal for retail, commercial and industrial applications. Standard finish is powder coat textured white. Optional silver, black or custom color paint finishes.

CONSTRUCTION

Die formed, 22 gauge, cold rolled steel designed for high strength.

END CAPS

End caps snap in for easy installation and maintenance. In addition, the end cap can be used as a joint aligner for continuous row mounting.

FINISH

White polyester polymer with high reflectivity. Optional silver, black or custom color paint finishes.

MOUNTING

Surface or suspension mount, individually or in continuous rows. Sufficient knockouts are provided.

APPLICATION

Suit for the garage, warehouse, basement and car parks and other places to provide general illumination.

LISTING / WARRANTY

ETL listed
5-year limited warranty on LED and Driver.



DIMENSIONS

W: 4 13/16"
H: 2 7/8"

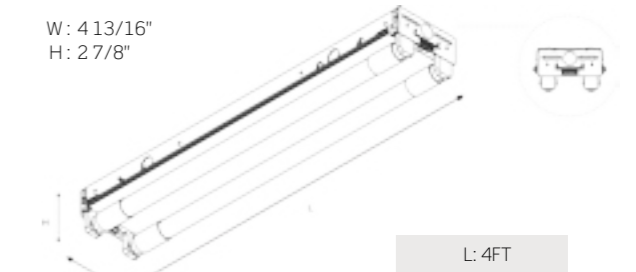

L: 4FT

PACKING

CTN Size: 1230x240x145mm (4 PCS/CTN)
Inner Box Size: 1225x125x55mm

MOUNTING



Suspended Mounted

Luminaires may be surface mounted or suspended, individually or in continuous row. Fixtures easily snap together for long continuous rows.

ORDERING GUIDE / YOUR PRODUCT CODE



SERIES	VOLTAGE	MOUNTING	FINISH
<input type="radio"/> DGL-4WT82 LED T8 Linear Wrap Light	<input type="radio"/> 120V ~ 277V AC	<input type="radio"/> Surface Mounted <input type="radio"/> Suspended Mounted	<input type="radio"/> White <input type="radio"/> Silver <input type="radio"/> Black

* Foot Double Tube

HIGH-PERFORMANCE 2X2 RECESSED LED TROFFER

LIGHT SOURCE LED T8 DGL-8WT82

Light Source is not included



Beam Angle: 100°

Power: 18W/Tube

Voltage: 120V ~ 277V AC

Frequency: 50/60Hz

CRI: 80+/90+

CCT: 2700-6500K

FEATURES

The product is a single tube or double tube T8 LED tube, providing high lumen, thin, elegant in appearance, safe and reliable, easy to install and maintenance linear Light. This series product is an industrial grade luminaires which is ideal for retail, commercial and industrial applications. Standard finish is powder coat textured white. Optional silver, black or custom color paint finishes.

CONSTRUCTION

Die formed, 22 gauge, cold rolled steel designed for high strength.

END CAPS

End caps snap in for easy installation and maintenance. In addition, the end cap can be used as a joint aligner for continuous row mounting.

FINISH

White polyester polymer with high reflectivity. Optional silver, black or custom color paint finishes.

MOUNTING

Surface or suspension mount, individually or in continuous rows. Sufficient knockouts are provided.

APPLICATION

Suit for the garage, warehouse, basement and car parks and other places to provide general illumination.

LISTING / WARRANTY

ETL listed
5-year limited warranty on LED and Driver.



DIMENSIONS

W: 4 13/16"
H: 2 7/8"



L: 8FT

PACKING

CTN Size: 2460x240x145mm (4 PCS/CTN)
Inner Box Size: 2445x125x55mm

MOUNTING



Suspended Mounted

Luminaires may be surface mounted or suspended, individually or in continuous row. Fixtures easily snap together for long continuous rows.

ORDERING GUIDE / YOUR PRODUCT CODE

SERIES	VOLTAGE	MOUNTING	FINISH
<input type="radio"/> DGL-8WT82 LED T8 Linear Wrap Light	<input type="radio"/> 120V ~ 277V AC	<input type="radio"/> Surface Mounted <input type="radio"/> Suspended Mounted	<input type="radio"/> White <input type="radio"/> Silver <input type="radio"/> Black

* Foot Single Tube

HIGH-PERFORMANCE 2X4 RECESSED LED TROFFER

LIGHT SOURCE LED T8 DGL-8WT84

Light Source is not included



Beam Angle: 100°

Power: 18W/Tube

Voltage: 120V ~ 277V AC

Frequency: 50/60Hz

CRI: 80+/90+

CCT: 2700-6500K

FEATURES

The product is a single tube or double tube T8 LED tube, providing high lumen, thin, elegant in appearance, safe and reliable, easy to install and maintenance linear Light. This series product is an industrial grade luminaires which is ideal for retail, commercial and industrial applications. Standard finish is powder coat textured white. Optional silver, black or custom color paint finishes.

CONSTRUCTION

Die formed, 22 gauge, cold rolled steel designed for high strength.

END CAPS

End caps snap in for easy installation and maintenance. In addition, the end cap can be used as a joint aligner for continuous row mounting.

FINISH

White polyester polymer with high reflectivity. Optional silver, black or custom color paint finishes.

MOUNTING

Surface or suspension mount, individually or in continuous rows. Sufficient knockouts are provided.

APPLICATION

Suit for the garage, warehouse, basement and car parks and other places to provide general illumination.

LISTING / WARRANTY

ETL listed
5-year limited warranty on LED and Driver.



DIMENSIONS

W: 4 13/16"
H: 2 7/8"

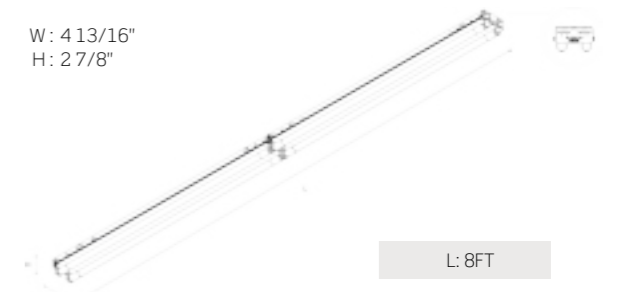

L: 8FT

PACKING

CTN Size: 2460x240x145mm (4 PCS/CTN)
Inner Box Size: 2445x125x55mm

MOUNTING



Suspended Mounted

Luminaires may be surface mounted or suspended, individually or in continuous row. Fixtures easily snap together for long continuous rows.

ORDERING GUIDE / YOUR PRODUCT CODE

SERIES	VOLTAGE	MOUNTING	FINISH
<input type="radio"/> DGL-8WT84 LED T8 Linear Wrap Light	<input type="radio"/> 120V ~ 277V AC	<input type="radio"/> Surface Mounted <input type="radio"/> Suspended Mounted	<input type="radio"/> White <input type="radio"/> Silver <input type="radio"/> Black

* Foot Double Tube

INSTALLATION INSTRUCTIONS

LED STRIP LIGHT

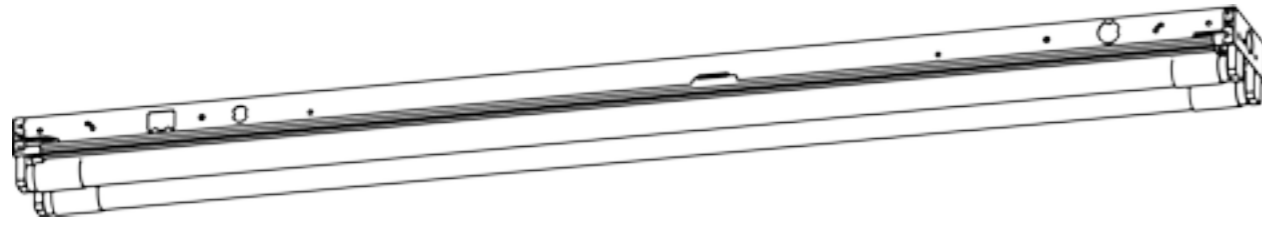

To reduce the risk of death, personal injury or property damage from fire, electric shock, falling parts, cuts/abrasions, and other hazards read all warnings and instructions included with and on the the fixture box and all fixture labels.
Before installing, servicing, or performing routine maintenance upon this equipment, follow these general precautions.
Commercial installation, service and maintenance of luminaires should be performed by a qualified licensed electrician.
For Residential installation: If you are unsure about the installation or maintenance of the luminaires, consult a qualified licensed electrician and check your local electrical code.
DO NOT INSTALL DAMAGED PRODUCT!

WARNING: RISK OF ELECTRICAL SHOCK

- Turn off electrical power at fuse or circuit breaker box before wiring fixture to the power supply.
- Turn off the power when you perform any maintenance.
- Verify that supply voltage is correct by comparing it with the luminaire label information.
- Make all electrical and grounded connections in accordance with the National Electrical Code and any applicable local code requirements.
- All wiring connections should be capped with UL approved wire connectors.

CAUTION: RISK OF INJURY

- Wear gloves and safety glasses at all times when removing luminaire from carton, installing, servicing or performing maintenance.
- Avoid direct eye exposure to the light source while it is on.
- Account for small parts and destroy packing material, as these may be hazardous to children.

WARNING: RISK OF BURN

- Allow fixture to cool before handling. Do not touch enclosure or light source.
- Do not exceed maximum wattage marked on luminaire label.
- Follow all lamp manufacturer's warnings, recommendations and restrictions for: driver type, burning position, mounting locations/methods, replacement, and recycling.

WARNING: RISK OF ELECTRICAL SHOCK

- Keep combustible and other materials that can burn away from luminaire and lamp/lens.
- Minimum 90° supply conductors.

REQUIRED TOOLS

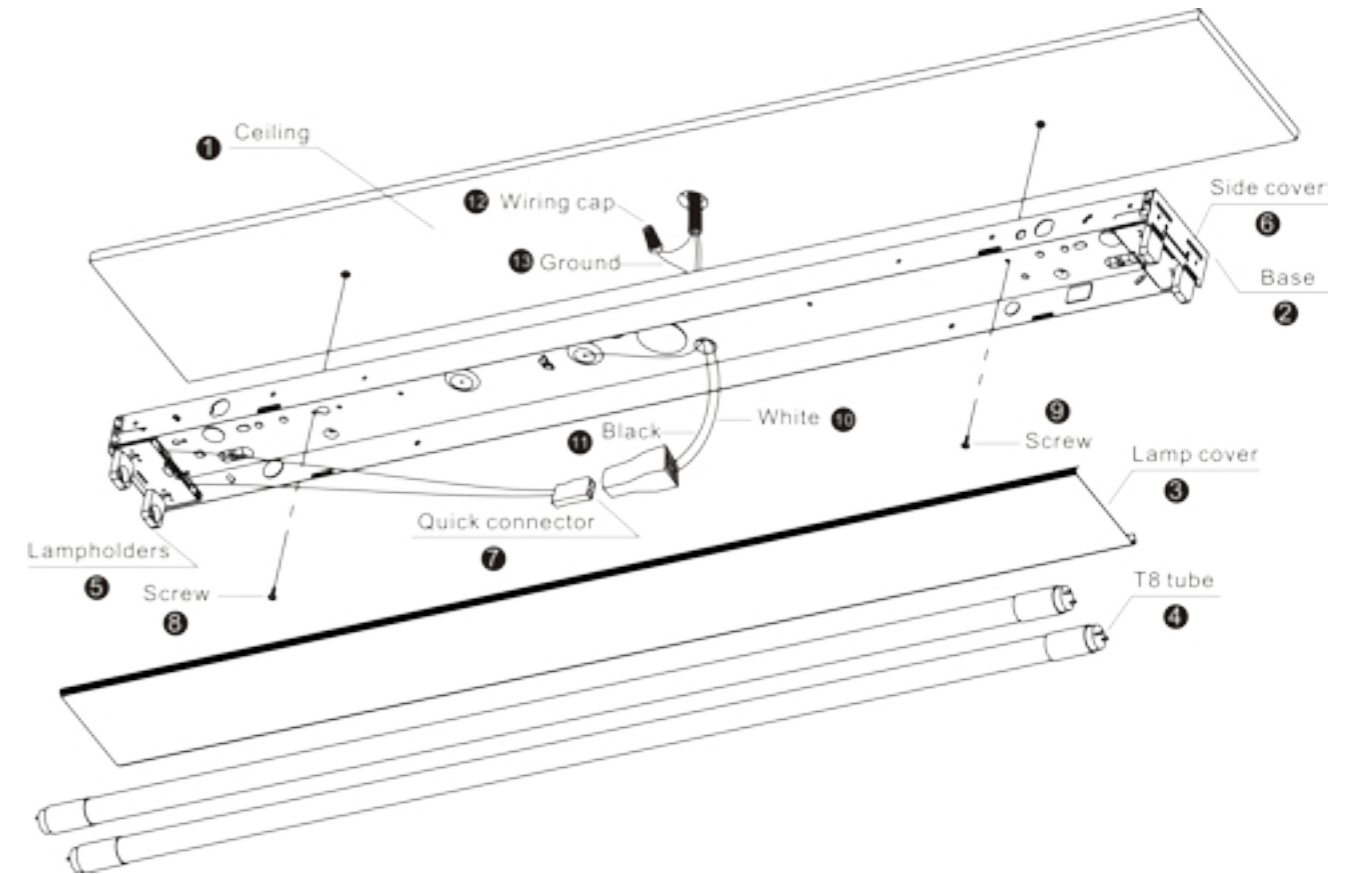

INSTALLATION STEPS:

1. Opening the Lights cover.
2. Fixing the fixtures base on the ceiling.
3. Connecting wires (white to white, black to black, green to green).
4. Fixing the socket for Tubes.
5. Installation and fixing the cover.
6. Installation the tubes.
7. Installation Done.

If this fixture fails to operate properly, use the guide below to diagnose and correct the problem.

- Verify that fixture is wired properly.
- Verify that fixture is grounded correctly.
- The line voltage at the fixture is correct.



LED TRACK LIGHT & ACCESSORIES

Liteharbor Lighting can provide low voltage/line voltage LED track light and track lighting accessories to meet any number of needs. We have components to build on or add to any existing track systems, and you can find a variety of top-of-the line track lights and the accessories at here.

Model: K1003

Low Volt. Gimbal Track Light
Complete with 12V 8W LED Driver

Lamp: LED MR16 12V 8W Max. GU5.3 Base
Finish: White/ Black/ Satin Nickel



Model: K1013

Low Volt. Track Light
Complete with 12V 8W LED Driver

Lamp: LED MR16 12V 8W Max. GU5.3 Base
Finish: White/ Black/ Satin Nickel



Model: K1023

Low Volt. Mesh Shade Track Light
Complete with 12V 8W LED Driver

Lamp: LED MR16 12V 8W Max. GU5.3 Base
Finish: White/ Black/ Satin Nickel



Model: K1063

Low Voltage Cylinder Track Light
Complete with 12V 8W LED Driver

Lamp: LED MR16 12V 8W Max. GU5.3 Base
Finish: White/ Black/ Satin Nickel



Model: K1103

Low Volt. Square Track Light
Complete with 12V 8W LED Driver

Lamp: LED MR16 12V 8W Max. GU5.3 Base
Finish: White/ Black/ Satin Nickel



Model: K1113

Low Volt. Octagon Track Light
Complete with 12V 8W LED Driver

Lamp: LED MR16 12V 8W Max. GU5.3 Base
Finish: White/ Black/ Satin Nickel





Model: K1523

Low Volt. Swivel Track Light
Complete with 12V 8W LED Driver

Lamp: LED MR16 12V 8W Max. GU5.3 Base
Finish: White/ Black/ Satin Nickel



Model: FM1523

Low Volt. Ceiling Mounted Track Light

Lamp: LED MR16 GU5.3 8W Max.
Finish: White/ Black/ Satin Nickel



Model: K2033

Line Volt. Gimbal Track Light

Lamp: LED PAR20 10W Max. E26 Base
Finish: White/ Black/ Satin Nickel



Model: K2043

Line Volt. Gimbal Track Light

Lamp: LED PAR30 18W Max. E26 Base
Finish: White/ Black/ Satin Nickel



Model: K2053

Line Volt. Gimbal Track Light

Lamp: LED PAR38 24W Max. E26 Base
Finish: White/ Black/ Satin Nickel



LOW VOLTAGE/ LINE VOLTAGE

Model: K2063

Line Volt. Mini Cylinder Track Light

Lamp: LED GU10 8W Max. GU10 Base
LED PAR16 8W Max. E26 Base
Finish: White/ Black/ Satin Nickel



Model: K2103

Line Volt. Square Track Light

Lamp: LED GU10 8W Max. GU10 Base
LED PAR16 8W Max. E26 Base
Finish: White/ Black/ Satin Nickel



Model: K2103-4C

Line Volt. Square Track Light 4 Heads

Lamp: LED GU10 8W/Lamp Max. GU10 Base
LED PAR16 8W/Lamp Max. E26 Base
Finish: White/ Black/ Satin Nickel



Model: K2013

Line Volt. Gimbal Track Light

Lamp: LED PAR20 10W Max. E26 Base
Finish: White/ Black/ Satin Nickel



Model: K2023

Line Volt. Adjustable Track Light

Lamp: LED PAR20 10W Max. E26 Base
LED PAR30 18W Max. E26 Base
LED PAR38 24W Max. E26 Base
Finish: White/ Black/ Satin Nickel



Model: K2113

Line Volt. Octagon Track Light

Lamp: LED GU10 8W Max. GU10 Base
LED PAR16 8W Max. E26 Base
Finish: White/ Black/ Satin Nickel



Model: K2203-XC

Line Volt. Canopy Mounted Mini Track Light

Lamp: LED GU10 8W/Lamp Max.
Finish: White/ Black/ Satin Nickel



Model: K2503

Line Volt. Bullet Track Light

Lamp: LED GU10 8W Max. GU10 Base
Finish: White/ Black/ Satin Nickel



Model: K2553

Line Volt. Round Back Track Light

Lamp: LED PAR20 10W Max. E26 Base
Finish: White/ Black**Model: K2553-4C**

Line Voltage Round Back Track Light 4 Heads

Lamp: LED PAR20 E26 10W/Lamp Max.
Finish: White/ Black/ Satin Nickel**Model: K2563**

Line Volt. Round Back Track Light

Lamp: LED PAR30 18W Max. E26 Base
Finish: White/ Black**Model: K2663**

Aluminum Die-casting Track Light

Lamp: LED PAR20 10W Max. E26 Base
Finish: White/ Black/ Satin Nickel**Model: K2663-4C**

Line Voltage Track Light 4 Heads

Lamp: LED PAR20 E26 10W/Lamp Max.
Finish: White/ Black/ Satin Nickel**Model: K2663-6C**

Aluminum Die-casting Track Light

Lamp: LED PAR20 10W/Lamp Max. E26 Base
Bar length: 72 inches
Finish: White/ Black/ Satin Nickel
Available Wall Mount and Ceiling Mount**Model: K2573**

Line Volt. Round Back Track Light

Lamp: LED PAR38 24W Max. E26 Base
Finish: White/ Black**Model: K2583**

Line Volt. Step Cylinder Track Light

Lamp: LED PAR20 10W Max. E26 Base
Finish: White/ Black**Model: K2593**

Line Volt. Step Cylinder Track Light

Lamp: LED PAR30 18W Max. E26 Base
Finish: White/ Black**Model: K2673**

Aluminum Die-casting Track Light

Lamp: LED GU10 8W Max. GU10 Base
LED PAR16 8W Max. E26 Base
Finish: White/ Black/ Satin Nickel**Model: K2683**

Line Volt. Bullet Track Lighting

Lamp: LED GU10 8W Max. GU10 Base
LED PAR16 8W Max. E26 Base
Finish: White/ Black/ Satin Nickel**Model: K2603**

Line Volt. Step Cylinder Track Light

Lamp: LED PAR38 24W Max. E26 Base
Finish: White/ Black**Model: K2643**

Line Volt. Swivel Track Light

Lamp: LED PAR20 10W Max. E26 Base
Finish: White/ Black/ Satin Nickel**Model: K2653**

Line Volt. Mini Swivel Track Light

Lamp: LED PAR20 10W Max. E26 Base
LED PAR30 18W Max. E26 Base
LED PAR38 24W Max. E26 Base
Finish: White/ Black**Model: K3003**

HID Metal Halide Track Light

120V electronic ballast standard
Lamp: 39W/ 70W PAR30MH HID Metal Halide
Finish: White/ Black/ Satin Nickel**Model: K3013**

HID Metal Halide Track Light

120V electronic ballast standard
Lamp: PAR38MH 100W Max. HID Metal Halide
Finish: White/ Black/ Satin Nickel

Model: K4003
Flood Wall Wash Track Light

Die-cast construction, specular parabolic louver
120V standard electronic ballast
Lamp: 26W DTT
32/42W TRT
LED 18W Max.
Finish: White/ Black/ Satin Nickel



Model: K4013
Flood Wall Wash Track Light

Specular parabolic louver
120V standard electronic ballast
Lamp: 2x40W TRT
LED 2x18W Max.
Finish: White/ Black/ Satin Nickel



Model: K4023
Flood Wall Wash Track Light

Specular parabolic louver
120V standard electronic ballast
Lamp: 2x32W/42W TRT
LED 2x18W Max.
Finish: White/ Black/ Satin Nickel

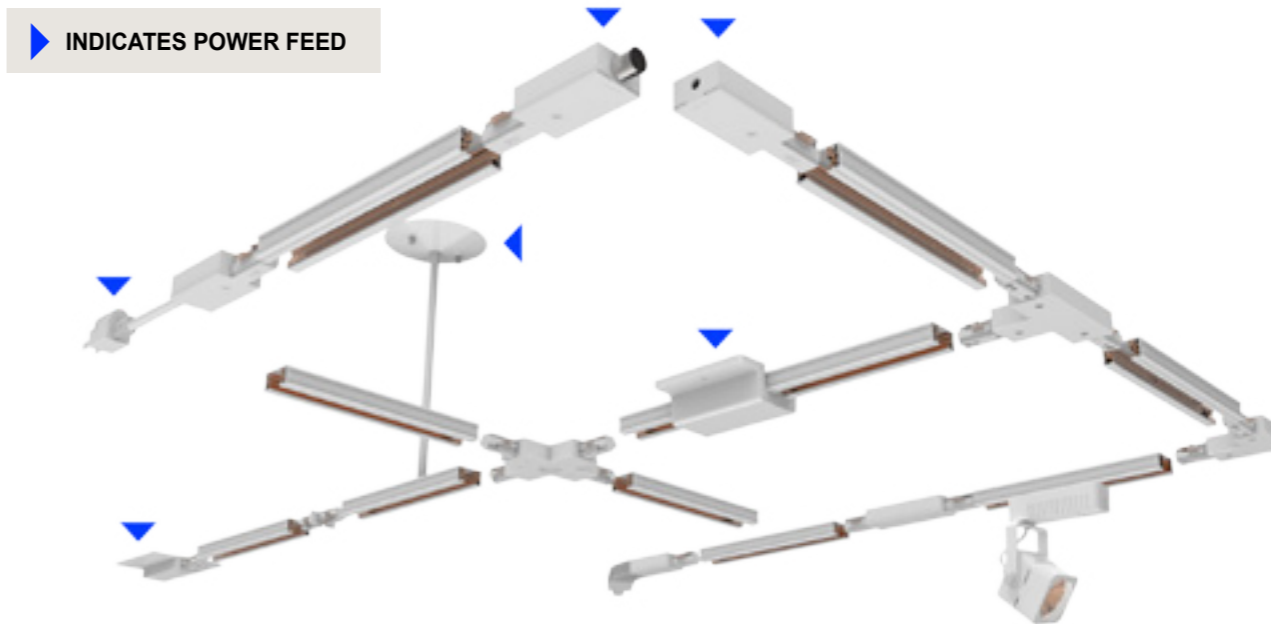

Model: KL0010
360 Degree Rotation Track light
Finish: White/ Black/ Silver/ Satin Nickel
Lamp: LED AR111
1300LM@18W
1990LM@22.5W
4000LM@33.8W
Narrow beam angles, 24° and 40°



Model: KL0011
Twin Light Track Light
Finish: White/ Black/ Silver/ Satin Nickel
Lamp: LED AR111
1300LM@18W per lamp
1990LM@22.5W per lamp
4000LM@33.8W per lamp
Narrow beam angles, 24° and 40°



Model: PR058-AR111-JC-CE
Four Barn Doors AR111 Track Light
Finish: White/ Black/ Silver/ Satin Nickel
Lamp: LED AR111
1300LM@18W
1990LM@22.5W
4000LM@33.8W
Narrow beam angles, 24° and 40°



Model: PR058-AR111-J-CE
Surface Mounted Four Barn Doors AR111 Track Light
Finish: White/ Black/ Silver/ Satin Nickel
Lamp: LED AR111
1300LM@18W
1990LM@22.5W
4000LM@33.8W
Narrow beam angles, 24° and 40°



PR058-PAR30-H
Four Barn Doors PAR30 Track Light
Finish: White/ Black/ Silver/ Satin Nickel
Lamp: LED PAR30
1440LM@18W



PR058-AR70-100-CE
Four Barn Doors AR70 Track Light
Finish: White/ Black/ Silver/ Satin Nickel
Lamp: LED AR70
800LM@10W



Model: K5-3
Single Circuit / Two Circuit Track

Single/ Two Circuit Track is available in white, black, and satin nickel finishes, and in 4, 6, and 8-foot sizes, and can also be field cut to your preference.

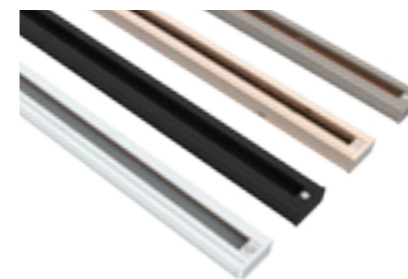

Model: K5-4
Two-Circuit/Two-Neutral Track

Available in 4ft, 8ft, and 12ft lengths; can be field cut to desired length
Low profile, easy and flexible; ideal for dimming intensive applications
Superior dimming capability gives the ability to dim on two independent circuits without harmonics or interference on the neutral conductor

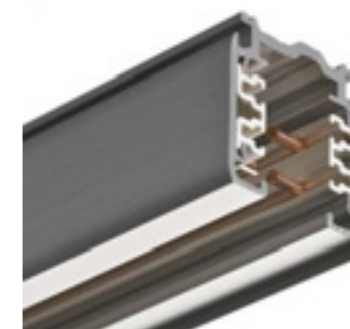

Model: K5-5
Single Circuit / Two Circuit Recessed Track

Available in 4ft and 8ft lengths
Use with 4ft and 8ft lengths of Single or Two-Circuit Track
Spacers are supplied to adjust for thickness of single or 2-circuit track
Finishes: White Enamel



Model: K500

Global Adaptor
Finish: WH/ BK



Model: K501

Pendant Fixture Adaptor: Cord
Finish: WH/BK



Model: K502

Square Adaptor
Finish: WH/BK



Model: K608

Mini Coupling
Finish: WH/ BK



Model: K609

Single / Two Circuit T-Connector
Finish: WH/ BK



Model: K610

Single Circuit 90° Connector
Finish: WH/ BK



Model: K503

Double-head Flexible Square Track Adaptor
Finish: WH/BK



Model: K600

Single / Two Circuit Live End
Finish: WH/ BK



Model: K601

Single / Two Circuit Conduit End Feed
Finish: WH/ BK



Model: K611

Single / Two Circuit X-Connector
Finish: WH/ BK



Model: K612

Live End with Cord&Plug
Finish: WH/ BK
Available in 2 wire, 3 wire, 4 wire



Model: K613

Barn Doors
Finish: WH/BK



Model: K602

Single / Two Circuit Flexible Connector
Finish: WH/ BK



Model: K603

2-Circuit Floating Feed Kit
- Can be installed anywhere along track
- Finishes: Black/ White/ Silver



Model: K604

T-bar Attachment Clips For T-bar Drop Ceiling
Finish: WH/ BK/ SN



Model: K614

Suspension Kit Extensions
Extends track from ceiling
Available with 12"/ 18" / 24"/36"/48"/72"/96" Stem



Model: K615

Track Suspension Kits with Canopy
Finish: WH/BK
Available in 12"/ 18" /24"/36"/48"

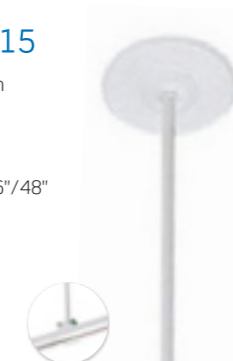

Model: K616

Sloped Ceiling Adaptor
Use with suspension kits to accommodate sloped ceilings
Finish: WH/BK



Model: K605

Single / Two Circuit Floating Canopy
Finish: WH/ BK



Model: K606

Single / Two Circuit Live End with Box Cover
Finish: WH/ BK



Model: K607

Track End Cap
Finish: WH/ BK





Use with LED Retrofit Downlight

RESIDENTIAL RECESSED HOUSING

Liteharbor offers the largest selection of high-quality recessed housing, incorporating industry leading performance, features and efficiency. Flat or sloped ceilings; ambient, task or accent lighting; niches or open spaces; Liteharbor has a solution for every conceivable application.

A4-LIA

4" NEW CONSTRUCTION IC AIRTIGHT LED RECESSED DOWNLIGHT HOUSING



USE WITH 4" LED RETROFIT DOWNLIGHT [▶](#)

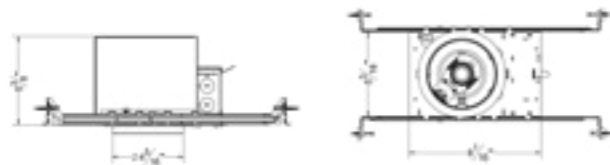

HOUSING

Die-formed aluminum for maximum heat dissipation and rust protection
Housing adjusts to 1/2" to 1 3/8" ceiling thickness. Trims are held in place with high tension clips
Housing is IC rated for direct contact with insulation and can be used in IC and NON-IC applications.

HANGER BAR

Allow housing to be positioned and locked at any point within a 24" joist span.
Can be shortened for 12" joists
Contain integral nail
Hanger fit onto T-bar spline for quick alignment

JUNCTION BOX

ETL listed for through branch wiring 1/2" and 3/4" romex wiring knockouts and four romex knockouts with integral strain clamps, all knockouts have true pry-out slots
J-Box is designed for straight through conduit runs
Removable access plates for easy installation

AIR-SHUT

Provided with gasket to prevent airflow from heated or air-conditioned spaces.
Meets or exceeds all national air flow requirements.

LISTING / WARRANTY

ETL listed to US and Canadian standards for damp location W/Feed through.
3 Years Limited Warranty.



A4-LRIA

4" REMODEL IC AIRTIGHT LED RECESSED DOWNLIGHT HOUSING



USE WITH 4" LED RETROFIT DOWNLIGHT [▶](#)

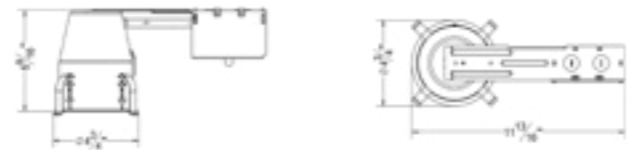

HOUSING

Die-formed aluminum for maximum heat dissipation and rust protection
Housing adjusts to 1/2" to 1 3/8" ceiling thickness. Trims are held in place with high tension clips
Housing is IC rated for direct contact with insulation and can be used in IC and NON-IC applications.

JUNCTION BOX

ETL listed for through branch wiring 1/2" and 3/4" romex wiring knockouts and four romex knockouts with integral strain clamps, all knockouts have true pry-out slots
J-Box is designed for straight through conduit runs
Removable access plates for easy installation

AIR-SHUT

Provided with gasket to prevent airflow from heated or air-conditioned spaces.
Meets or exceeds all national air flow requirements.

LISTING / WARRANTY

ETL listed to US and Canadian standards for damp location W/Feed through.
3 Years Limited Warranty.



A6-LIA

6" NEW CONSTRUCTION IC AIRTIGHT LED RECESSED DOWNLIGHT HOUSING

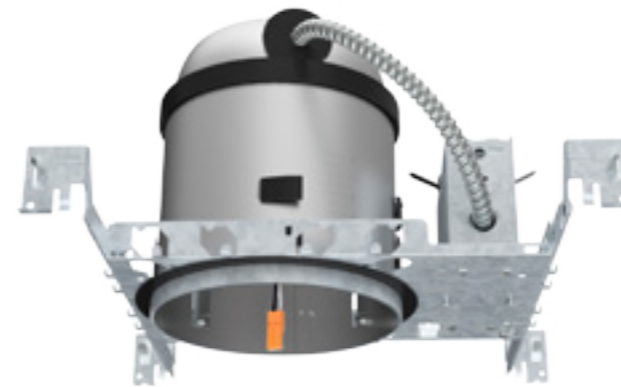

USE WITH 6" LED RETROFIT DOWNLIGHT [▶](#)

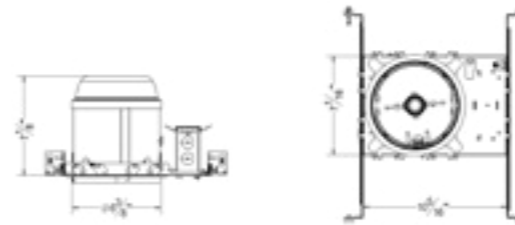

HOUSING

Die-formed aluminum for maximum heat dissipation and rust protection
Housing adjusts to 1/2" to 1 3/8" ceiling thickness. Trims are held in place with high tension clips
Housing is IC rated for direct contact with insulation and can be used in IC and NON-IC applications.

HANGER BAR

Allow housing to be positioned and locked at any point within a 24" joist span.
Can be shortened for 12" joists
Contain integral nail
Hanger fit onto T-bar spline for quick alignment

JUNCTION BOX

ETL listed for through branch wiring 1/2" and 3/4" romex wiring knockouts and four romex knockouts with integral strain clamps, all knockouts have true pry-out slots
J-Box is designed for straight through conduit runs
Removable access plates for easy installation

AIR-SHUT

Provided with gasket to prevent airflow from heated or air-conditioned spaces.
Meets or exceeds all national air flow requirements.

LISTING / WARRANTY

ETL listed to US and Canadian standards for damp location W/Feed through.
3 Years Limited Warranty.



A6-LRIA

6" REMODEL IC AIRTIGHT LED RECESSED DOWNLIGHT HOUSING



USE WITH 6" LED RETROFIT DOWNLIGHT [▶](#)



HOUSING

Die-formed aluminum for maximum heat dissipation and rust protection
Housing adjusts to 1/2" to 1 3/8" ceiling thickness. Trims are held in place with high tension clips
Housing is IC rated for direct contact with insulation and can be used in IC and NON-IC applications.

JUNCTION BOX

ETL listed for through branch wiring 1/2" and 3/4" romex wiring knockouts and four romex knockouts with integral strain clamps, all knockouts have true pry-out slots
J-Box is designed for straight through conduit runs
Removable access plates for easy installation

AIR-SHUT

Provided with gasket to prevent airflow from heated or air-conditioned spaces.
Meets or exceeds all national air flow requirements.

LISTING / WARRANTY

ETL listed to US and Canadian standards for damp location W/Feed through.
3 Years Limited Warranty.





4" | 5" | 6"

LED RETROFIT

Liteharbor LED Retrofit Kits are available to ensure you get the right fit for your retrofit project. With LED retrofit kits, you can incorporate LED lighting into any existing recessed downlight without worrying about a complicated installation.

BL4-001

4" LED DOWNLIGHT MODULE RETROFIT

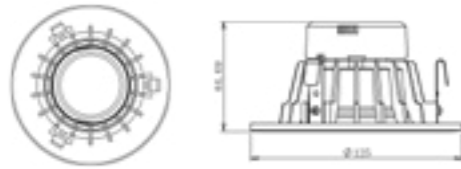

DESCRIPTION

All-in-one LED retrofit trim designed to use with Liteharbor 4 inch recessed residential downlights
Trim shipped with a medium base socket adapter whip
Available with dedicated Emergency Battery Back-up

LED LIGHT ENGINE

Cree true white technology available
12w max.; Luminous efficacy of light source: 100lm/w
CRI>80, Color temperature 2700K-5000K
Rated for 50000 hours at 70% lumen output

DRIVER

Dedicated 120 volt driver
Power factor >0.9
Dimmable to 10% with most brand dimmers
Rated for 50 to 60Hz at 120V/277V input
Produces less than 20% THD



ORDERING GUIDE / YOUR PRODUCT CODE ✓

SERIES	INPUT VOLTAGE	DIMMABLE
○ BL4-001 4" LED Downlight Module Retrofit	○ 120V ○ 277V ○ 120-277V	○ Non-Dimmable ○ Dimmable
LUMEN OUTPUT	CCT	FINISH
○ 600 Lumen ○ 800 Lumen	○ 2700K ○ 4000K ○ 5000K	○ White ○ Black ○ Satin Nickel
LED AVAILABLE		
○ Cree ○ Citizen	○ Epistar ○ Seoul	○ Osram

* Customized Also Available

BSL4-001

4" LED DOWNLIGHT SQUARE RETROFIT



DESCRIPTION

All-in-one LED retrofit trim designed to use with Liteharbor 4 inch recessed residential downlights
Trim shipped with a medium base socket adapter whip
Available with dedicated Emergency Battery Back-up

LED LIGHT ENGINE

Cree true white technology available
12w max.; Luminous efficacy of light source: 100lm/w
CRI>80, Color temperature 2700K-5000K
Rated for 50000 hours at 70% lumen output

DRIVER

Dedicated 120 volt driver
Power factor >0.9
Dimmable to 10% with most brand dimmers
Rated for 50 to 60Hz at 120V/277V input
Produces less than 20% THD



ORDERING GUIDE / YOUR PRODUCT CODE ✓

SERIES	INPUT VOLTAGE	DIMMABLE
○ BSL4-001 4" LED Downlight Square	○ 120V ○ 277V ○ 120-277V	○ Non-Dimmable ○ Dimmable
LUMEN OUTPUT	CCT	FINISH
○ 600 Lumen ○ 800 Lumen	○ 3000K ○ 4000K ○ 5000K	○ White ○ Black ○ Satin Nickel
LED AVAILABLE		
○ Cree ○ Citizen	○ Epistar ○ Seoul	○ Osram

* Customized Also Available

BL4-001-1

4" LED DOWNLIGHT MODULE

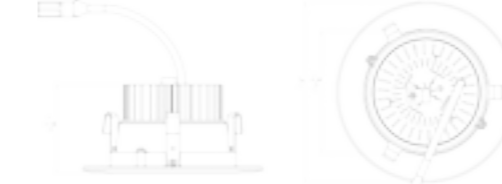

DESCRIPTION

All-in-one LED retrofit trim designed to use with Liteharbor 4 inch recessed residential downlight.
Trim shipped with a medium base socket adapter whip.

DRIVER

Dedicated 120 volt driver
Power factor >0.98
Dimmable to 10% with most brand dimmers
Rated for 50 to 60Hz at 120V/277V input
Produces less than 20% THD

LED LIGHT ENGINE

Cree true white® technology available
Color temperature: 2700K-6500K
Rated for 50000 hours at 70% lumen output
CRI> 80/90
Luminous flux: 620lm/720lm
Light effect: 80lm/w&68lm/w



ORDERING GUIDE / YOUR PRODUCT CODE ✓

SERIES	INPUT VOLTAGE	DIMMABLE
○ BL4-001-1 4" LED Downlight Module	○ 120V ○ 277V	○ Non-Dimmable ○ Dimmable
LUMEN OUTPUT	CCT	FINISH
○ 620 Lumen ○ 720 Lumen	○ 2700K ○ 3000K ○ 6500K	○ White ○ Black ○ Satin Nickel
LED AVAILABLE		
○ Cree ○ Citizen	○ Epistar ○ Seoul	○ Osram

* Customized Also Available

BL4-001-E

4" LED DOWNLIGHT RETROFIT



DESCRIPTION

LED retrofit designed for recessed downlight.
Compatible with most brand TRIAC dimmers, dimmable to 5% with no flicker.
High transmittance, high diffusion, 92% light transmittance.
Concealed light source.

LAMP BODY

Steel body material used die spinning technique, can be electroplated or sprayed, long-term use without discoloration.

POWER SUPPLY

Scheme for high voltage AC, 50000 hours long life-span.

DIFFUSER PLATE

Using imported high transmittance diffusion plate.

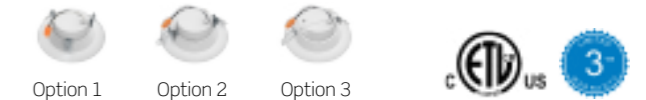

ORDERING GUIDE / YOUR PRODUCT CODE ✓

SERIES	INPUT VOLTAGE	DIMMABLE
○ BL4-001-E LED Retrofit	○ 120V ○ 277V	○ Non-Dimmable ○ Dimmable
MOUNTING	CCT	FINISH
○ Option 1 ○ Option 2 ○ Option 3	○ 2700K ○ 3000K ○ 3500K ○ 4100K	○ White ○ Black ○ Satin Nickel
LED AVAILABLE		
○ Cree ○ Citizen	○ Epistar ○ Seoul	○ Osram

* Customized Also Available

BL4-002

4" LED DOWNLIGHT MODULE RETROFIT



DESCRIPTION

All-in-one LED retrofit trim designed to use with Liteharbor 4 inch recessed residential downlight
Trim shipped with a medium base socket adapter whip
Available with dedicated Emergency Battery Back-up

LED LIGHT ENGINE

Cree true white technology available
12w max.; Luminous efficacy of light source: 100lm/w
CRI>80, Color temperature: 3000K-5000K
Rated for 50000 hours at 70% lumen output

DRIVER

Dedicated 120 volt driver
Power factor >0.9
Dimmable to 10% with most brand dimmers
Rated for 50 to 60Hz at 120V/277V input
Produces less than 20% THD



ORDERING GUIDE / YOUR PRODUCT CODE ✓

SERIES	INPUT VOLTAGE	DIMMABLE
○ BL4-002 4" LED Downlight Module Retrofit	○ 120V ○ 277V	○ Non-Dimmable ○ Dimmable
LUMEN OUTPUT	CCT	FINISH
○ 600 Lumen ○ 800 Lumen	○ 3000K ○ 4000K ○ 5000K	○ White ○ Black ○ Satin Nickel
LED AVAILABLE		
○ Cree ○ Citizen	○ Epistar ○ Seoul	○ Osram

* Customized Also Available

BL4-003

4" LOW PROFILE LED DISK LIGHT



DESCRIPTION

120V LED disk light provides surface mount light for most construction.
It fits most 4 inch junction boxes and can replace 5 inch and 6 inch recessed can lights to eliminate baffles.
And it is suitable for use in dry, damp locations indoor/outdoor enclosed applications.

THIS FIXTURE CAN BE SURFACE MOUNTED OR RECESSED MOUNTED

DRIVER

120V 60Hz AC operation
15W 36pcs LED chips
Light source lumens: 1250; Fixture lumens: 1050
Translucent white PC opal diffuser
Two mounting screws
Philips screw driver sold separately



ORDERING GUIDE / YOUR PRODUCT CODE ✓

SERIES	INPUT VOLTAGE	DIMMABLE
○ BL4-003 LED Recessed Disk Light	○ 120V ○ 277V	○ Non-Dimmable ○ Dimmable
LUMEN OUTPUT	CCT	FINISH
○ 1050 Lumen ○ 1250 Lumen	○ 3000K ○ 4000K ○ 5000K	○ White ○ Black ○ Satin Nickel
LED AVAILABLE		
○ Cree ○ Citizen	○ Epistar ○ Seoul	○ Osram

* Customized Also Available

BL4-013

4" LED DOWNLIGHT MODULE

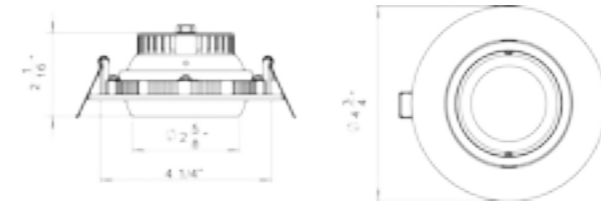

DESCRIPTION

Round 4" Gimbal fixtures with integral LEDs.
Isolated external driver factory installed inside junction box.
One driver for every fixture required.
IC (Direct Contact with Insulation) Rated Air-Tight

REFLECTOR

120V AC 50/60 Hz (Dimmable)
277V-347V AC 50/60 Hz (Not Dimmable)
600LM / 800LM
LED 7.5W / 11W
Halogen Equivalent 50W
PF > 0.95
40° Beam Angle with 30° tilt and 360° rotation
CCT 2700K / 3000K / 4000K
CRI > 80 / 90
None Dimmable or TRIAC Dimmable



ORDERING GUIDE / YOUR PRODUCT CODE ✓

SERIES	INPUT VOLTAGE	DIMMABLE
○ BL4-013 4" LED Downlight Module	○ 120V ○ 277V ○ 120-277V	○ Non-Dimmable ○ Dimmable
WATTAGE / LUMEN	CCT	FINISH
○ 7.5W / 600 Lumen ○ 11W / 800 Lumen	○ 2700K ○ 3000K ○ 4000K	○ White ○ Black ○ Satin Nickel
LED AVAILABLE		
○ Cree ○ Citizen	○ Epistar ○ Seoul	○ Osram

* Customized Also Available

BAL4-001

4" LED DOWNLIGHT DIRECTIONAL GIMBAL RETROFIT

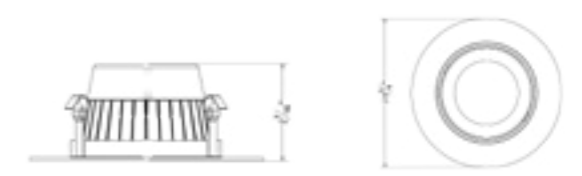

DESCRIPTION

All-in-one LED retrofit gimbal trim designed to use with Liteharbor 4 inch recessed residential downlight
Allows for swivels 30° and rotates 355° adjustment
Trim shipped with a medium base socket adapter whip
Available with dedicated Emergency Battery Back-up

LED LIGHT ENGINE

Cree true white technology available
12w max.; Luminous efficacy of light source: 100lm/w
CRI>80, Color temperature: 2700K-6000K
Rated for 50000 hours at 70% lumen output

DRIVER

Dedicated 120 volt driver
Power factor >0.9
Dimmable to 10% with most brand dimmers
Rated for 50 to 60Hz at 120V/277V input
Produces less than 20% THD



ORDERING GUIDE / YOUR PRODUCT CODE ✓

SERIES	INPUT VOLTAGE	DIMMABLE
○ BAL4-001 4" LED Downlight Directional Gimbal	○ 120V ○ 277V ○ 120-277V	○ Non-Dimmable ○ Dimmable
LUMEN OUTPUT	CCT	FINISH
○ 600 Lumen ○ 800 Lumen	○ 2700K ○ 4000K ○ 5000K	○ White ○ Black ○ Satin Nickel
LED AVAILABLE		
○ Cree ○ Citizen	○ Epistar ○ Seoul	○ Osram

* Customized Also Available

BEL4-001

4" LED DOWNLIGHT EYEBALL RETROFIT



DESCRIPTION

All-in-one LED retrofit eyeball trim designed to use with Liteharbor 4 inch recessed residential downlight
Allows for 30° vertical adjustment
Trim shipped with a medium base socket adapter whip

LED LIGHT ENGINE

Cree true white technology available
12w max.; Luminous efficacy of light source: 100lm/w
CRI>80, Color temperature: 3000K-5000K
Rated for 50000 hours at 70% lumen output

DRIVER

Dedicated 120 volt driver
Power factor >0.9
Dimmable to 10% with most brand dimmers
Rated for 50 to 60Hz at 120V/277V input
Produces less than 20% THD



ORDERING GUIDE / YOUR PRODUCT CODE ✓

SERIES	INPUT VOLTAGE	DIMMABLE
<input type="radio"/> BEL4-001 4" LED Downlight Eyeball Retrofit	<input type="radio"/> 120V <input type="radio"/> 277V	<input type="radio"/> Non-Dimmable <input type="radio"/> Dimmable
LUMEN OUTPUT	CCT	FINISH
<input type="radio"/> 600 Lumen <input type="radio"/> 800 Lumen	<input type="radio"/> 3000K <input type="radio"/> 4000K <input type="radio"/> 5000K	<input type="radio"/> White <input type="radio"/> Black <input type="radio"/> Satin Nickel
LED AVAILABLE		
<input type="radio"/> Cree <input type="radio"/> Citizen	<input type="radio"/> Epistar <input type="radio"/> Seoul	<input type="radio"/> Osram

* Customized Also Available

BWL4-001

4" LED DOWNLIGHT WALL WASHER RETROFIT



DESCRIPTION

All-in-one LED retrofit wall washer trim designed to use with Liteharbor 4 inch recessed residential downlight
Trim shipped with a medium base socket adapter whip

LED LIGHT ENGINE

Cree true white® technology available
12w max.; Luminous efficacy of light source: 100lm/w
CRI>80, Color temperature: 3000K-5000K
Rated for 50000 hours at 70% lumen output

DRIVER

Dedicated 120 volt driver
Power factor >0.9
Dimmable to 10% with most brand dimmers
Rated for 50 to 60Hz at 120V/277V input
Produces less than 20% THD



ORDERING GUIDE / YOUR PRODUCT CODE ✓

SERIES	INPUT VOLTAGE	DIMMABLE
<input type="radio"/> BWL4-001 4" LED Downlight Wall Washer	<input type="radio"/> 120V <input type="radio"/> 277V	<input type="radio"/> Non-Dimmable <input type="radio"/> Dimmable
LUMEN OUTPUT	CCT	FINISH
<input type="radio"/> 600 Lumen <input type="radio"/> 800 Lumen	<input type="radio"/> 3000K <input type="radio"/> 4000K <input type="radio"/> 5000K	<input type="radio"/> White <input type="radio"/> Black <input type="radio"/> Satin Nickel
LED AVAILABLE		
<input type="radio"/> Cree <input type="radio"/> Citizen	<input type="radio"/> Epistar <input type="radio"/> Seoul	<input type="radio"/> Osram

* Customized Also Available

BRL4-001-SF

4" LED DOWNLIGHT DEEP REFLECTOR RETROFIT

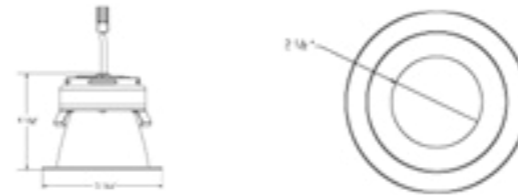

DESCRIPTION

Compatible with Liteharbor 4 inch recessed downlight
Designed to last a minimum 50,000 hours at L70
Dimmable to 10% with most brand dimmers
12w max.; Luminous efficacy of light source: 100lm/w

REFLECTOR

Reflector is high quality available in clear, semi diffuse or white finish.
Self flange trim is standard.

FEATURES

Deep set LED for superior glare and cut-off
Cree True White technology
Comprehensive solution with driver electronics, optics and core thermals
Versatile form factor for small-aperture designs
With integral power supply

MOUNTING

Spring clips safely secure LED trim and module to housing.



ORDERING GUIDE / YOUR PRODUCT CODE ✓

SERIES	INPUT VOLTAGE	DIMMABLE
<input type="radio"/> BRL4-001-SF 4" LED Downlight Deep Reflector	<input type="radio"/> 120V <input type="radio"/> 277V	<input type="radio"/> Non-Dimmable <input type="radio"/> Dimmable
LUMEN OUTPUT	CCT	LED AVAILABLE
<input type="radio"/> 700 Lumen <input type="radio"/> 950 Lumen	<input type="radio"/> 3000K <input type="radio"/> 4000K <input type="radio"/> 5000K	<input type="radio"/> Cree <input type="radio"/> Citizen <input type="radio"/> Epistar <input type="radio"/> Seoul <input type="radio"/> Osram
FINISH	FINISH	LENS TYPE
<input type="radio"/> Self Flanged <input type="radio"/> Self Flanged White	<input type="radio"/> Clear <input type="radio"/> Haze <input type="radio"/> White	<input type="radio"/> Clear Tempered <input type="radio"/> Sand Blasted

* Customized Also Available

BRL4-002-SF

4" LED DOWNLIGHT SHALLOW REFLECTOR RETROFIT



DESCRIPTION

Compatible with Liteharbor 4 inch recessed downlight
Designed to last a minimum 50,000 hours at L70
Dimmable to 10% with most brand dimmers
12w max.; Luminous efficacy of light source: 100lm/w

REFLECTOR

Reflector is high quality available in clear, semi diffuse or white finish.
Self flange trim is standard.

FEATURES

Deep set LED for superior glare and cut-off
Cree True White technology
Comprehensive solution with driver electronics, optics and core thermals
Versatile form factor for small-aperture designs
With integral power supply

MOUNTING

Spring clips safely secure LED trim and module to housing.



ORDERING GUIDE / YOUR PRODUCT CODE ✓

SERIES	INPUT VOLTAGE	DIMMABLE
<input type="radio"/> BRL4-002-SF 4" LED Downlight Shallow Reflector	<input type="radio"/> 120V <input type="radio"/> 277V	<input type="radio"/> Non-Dimmable <input type="radio"/> Dimmable
LUMEN OUTPUT	CCT	LED AVAILABLE
<input type="radio"/> 700 Lumen <input type="radio"/> 950 Lumen	<input type="radio"/> 3000K <input type="radio"/> 4000K <input type="radio"/> 5000K	<input type="radio"/> Cree <input type="radio"/> Citizen <input type="radio"/> Epistar <input type="radio"/> Seoul <input type="radio"/> Osram
FINISH	FINISH	LENS TYPE
<input type="radio"/> Self Flanged <input type="radio"/> Self Flanged White	<input type="radio"/> Clear <input type="radio"/> Haze <input type="radio"/> White	<input type="radio"/> Clear Tempered <input type="radio"/> Sand Blasted

* Customized Also Available

BL5-003

5" LED DOWNLIGHT RETROFIT



DESCRIPTION

All-in-one LED baffle retrofit trim designed to use with Liteharbor 5 inch recessed residential downlight. Trim shipped with a medium base socket adapter whip.

LED LIGHT ENGINE

Cree true white® technology available
12w max.; Luminous efficacy of light source: 100lm/w
CRI>80, Color temperature: 2700K-5000K
Rated for 50000 hours at 70% lumen output

DRIVER

Dedicated 120 volt driver
Power factor >0.9
Dimmable to 10% with most brand dimmers
Rated for 50 to 60Hz at 120V/277V input
Produces less than 20% THD



ORDERING GUIDE / YOUR PRODUCT CODE ✓

SERIES	INPUT VOLTAGE	DIMMABLE
○ BL5-003 5" LED Downlight Retrofit	○ 120V ○ 277V ○ 120-277V	○ Non-Dimmable ○ Dimmable
LUMEN OUTPUT	CCT	FINISH
○ 1100 Lumen ○ 1250 Lumen	○ 2700K ○ 4000K ○ 5000K	○ White ○ Black ○ Satin Nickel
LED AVAILABLE		
○ Cree ○ Citizen	○ Epistar ○ Seoul	○ Osram

* Customized Also Available

BL6-001

6" BAFFLE LED RETROFIT



DESCRIPTION

All-in-one LED baffle retrofit trim designed to use with Liteharbor 6 inch recessed residential downlight. Trim shipped with a medium base socket adapter whip.

LED LIGHT ENGINE

Cree true white® technology available
16w max.; Luminous efficacy of light source: 100lm/w
CRI>80, Color temperature: 2700K-5000K
Rated for 50000 hours at 70% lumen output

DRIVER

Dedicated 120 volt driver
Power factor >0.9
Dimmable to 10% with most brand dimmers
Rated for 50 to 60Hz at 120V/277V input
Produces less than 20% THD



ORDERING GUIDE / YOUR PRODUCT CODE ✓

SERIES	INPUT VOLTAGE	DIMMABLE
○ BL6-001 6" LED Downlight Retrofit	○ 120V ○ 277V ○ 120-277V	○ Non-Dimmable ○ Dimmable
WATTAGE / LUMEN	CCT	FINISH
○ 1100 Lumen ⊕ 1250 Lumen ○	○ 2700K ○ 4000K ○ 5000K	○ White ○ Black ○ Satin Nickel
LED AVAILABLE		
○ Cree ⊕ Citizen ○	○ Epistar ○ Seoul	○ Osram

* Customized Also Available

BL6-001-1

6" LED DOWNLIGHT MODULE

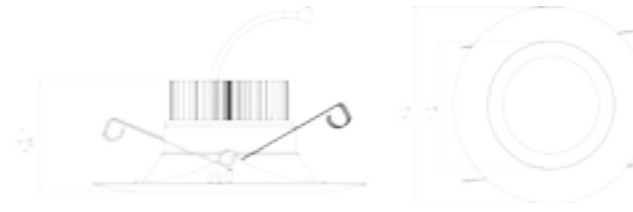

DESCRIPTION

All-in-one LED retrofit trim designed to use with Liteharbor 6 inch recessed residential downlight. Trim shipped with a medium base socket adapter whip.

DRIVER

Dedicated 120 volt driver
Power factor >0.98
Dimmable to 10% with most brand dimmers
Rated for 50 to 60Hz at 120V/277V input
Produces less than 20% THD

LED LIGHT ENGINE

Cree true white® technology available
Color temperature: 2700K-6500K
Rated for 50000 hours at 70% lumen output
CRI>80 / 90
Luminous flux: 1250lm & 1100lm
Light effect: 78lm/w & 68lm/w



ORDERING GUIDE / YOUR PRODUCT CODE ✓

SERIES	INPUT VOLTAGE	DIMMABLE
○ BL6-001-1 6" LED Downlight Module	○ 120V ○ 277V	○ Non-Dimmable ○ Dimmable
LUMEN OUTPUT	CCT	FINISH
○ 1100 Lumen ○ 1250 Lumen	○ 2700K ○ 3000K ○ 6500K	○ White ○ Black ○ Satin Nickel
LED AVAILABLE		
○ Cree ○ Citizen	○ Epistar ○ Seoul	○ Osram

* Customized Also Available

BL6-001-E

HIGH VOLTAGE - LED RETROFIT

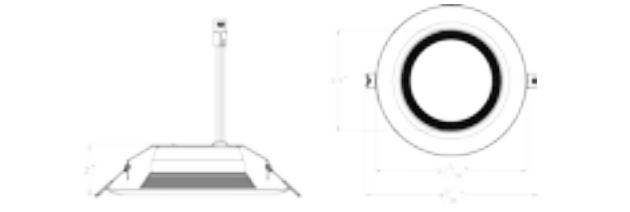

DESCRIPTION

LED retrofit designed for recessed downlight. Compatible with most brand TRIAC dimmers, dimmable to 5% with no flicker. High transmittance, high diffusion, 92% light transmittance. Concealed light source. 16w max.; Luminous efficacy of light source: 100lm/w

LAMP BODY

Steel body material used die spinning technique, can be electroplated or sprayed, long-term use without discoloration.

POWER SUPPLY

Scheme for high voltage AC, 50000 hours long life-span.

DIFFUSER PLATE

Using imported high transmittance diffusion plate.



ORDERING GUIDE / YOUR PRODUCT CODE ✓

SERIES	INPUT VOLTAGE	DIMMABLE
○ BL6-001-E LED Retrofit	○ 120V ○ 277V	○ Non-Dimmable ○ Dimmable
Mounting	CCT	FINISH
○ Option 1 ○ Option 2	○ 2700K ○ 3000K ○ 3500K ○ 4100K	○ White ○ Black ○ Satin Nickel
LED AVAILABLE		
○ Cree ○ Citizen	○ Epistar ○ Seoul	○ Osram

* Customized Also Available

BL6-001-COB

6" COB LED RETROFIT TRIM

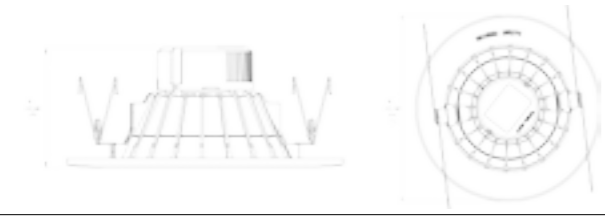

DESCRIPTION

COB retrofit trim designed to use with Liteharbor 6 inch recessed residential downlight. Using die-casting aluminum casting, good heat dissipation, high transmittance lens and diffusion film, can change the beam angle.

FEATURES

Using high-quality COB light source and high transmittance lens, high luminous efficiency.
Can choose to use different types of diffusion film to change the beam angle; can change to 10°, 12°, 20°, 30°, 45°, 55°, 60°.
Dimmable, dimmer compatibility is good, can match the multi-brand dimmer, dimming effect is good (dimming stable even, no strobe).

SPECIFICATIONS

Material: Die cast aluminum
PF: >0.9
CRI: 80+/90+
Dimmable: None/TRIAC
16w max.; Luminous efficacy of light source: 100lm/w



ORDERING GUIDE / YOUR PRODUCT CODE ✓

SERIES	INPUT VOLTAGE	DIMMABLE
○ BL6-001-COB COB LED Downlight housing	○ 120V ○ 277V ○ 347V	○ Non-Dimmable ○ Dimmable
Wattage	CCT	FINISH
○ 12W ○ 14W	○ 3000K ○ 3500K ○ 4100K	○ White ○ Black ○ Satin Nickel
LED AVAILABLE		
○ Cree ○ Citizen	○ Epistar ○ Seoul	○ Osram

* Customized Also Available

BL6-003

6" LOW PROFILE LED DISK LIGHT

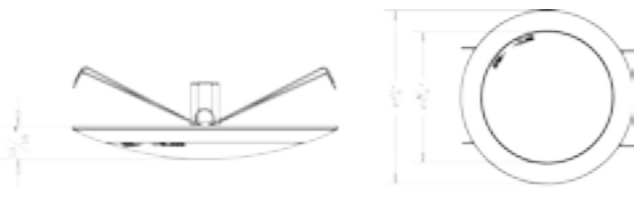

DESCRIPTION

120V LED disk light provides surface mount light for most construction. It fits most 6 inch junction boxes and can replace 5 inch recessed can lights to eliminate baffles.
And it is suitable for use in dry, damp locations indoor/outdoor enclosed applications.

THIS FIXTURE CAN BE SURFACE MOUNTED OR RECESSED MOUNTED

TECHNICAL SPECIFICATIONS

120V 60Hz AC operation
15W 28pcs LED chips
Light source lumens: 1500; Fixture lumens: 1076
Translucent white PC opal diffuser
Two mounting screws
Philips screw driver sold separately



ORDERING GUIDE / YOUR PRODUCT CODE ✓

SERIES	INPUT VOLTAGE	DIMMABLE
○ BL6-003 6" Recessed Disk Light	○ 120V ○ 277V ○ 120-277V	○ Non-Dimmable ○ Dimmable
LUMEN OUTPUT	CCT	FINISH
○ 1500 Lumen Max.	○ 3000K ○ 4000K ○ 5000K	○ White ○ Black ○ Satin Nickel
LED AVAILABLE		
○ Cree ○ Citizen	○ Epistar ○ Seoul	○ Osram

* Customized Also Available

BEL6-001

6" LED DOWNLIGHT EYEBALL RETROFIT

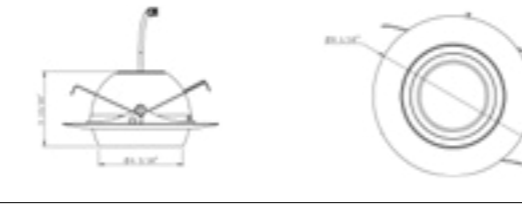

DESCRIPTION

All-in-one LED retrofit eyeball trim designed to use with Liteharbor 6 inch recessed residential downlight.
Allows for 30° vertical adjustment
Trim shipped with a medium base socket adapter whip

LED LIGHT ENGINE

Cree true white technology available
16w max.; Luminous efficacy of light source: 100lm/w
CRI>80, Color temperature: 3000K-5000K
Rated for 50000 hours at 70% lumen output

DRIVER

Dedicated 120 volt driver
Power factor >0.9
Dimmable to 10% with most brand dimmers
Rated for 50 to 60Hz at 120V/277V input
Produces less than 20% THD



ORDERING GUIDE / YOUR PRODUCT CODE ✓

SERIES	INPUT VOLTAGE	DIMMABLE
○ BEL6-001 6" LED Downlight Eyeball Retrofit	○ 120V ○ 277V	○ Non-Dimmable ○ Dimmable
LUMEN OUTPUT	CCT	FINISH
○ 900 Lumen ○ 1200 Lumen	○ 3000K ○ 4000K ○ 5000K	○ White ○ Black ○ Satin Nickel
LED AVAILABLE		
○ Cree ○ Citizen	○ Epistar ○ Seoul	○ Osram

* Customized Also Available

BL6-006

6" LED DOWNLIGHT WALL WASHER RETROFIT

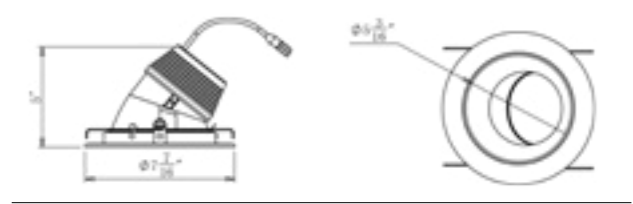

DESCRIPTION

All-in-one LED retrofit wall washer trim designed to use with Liteharbor 6 inch recessed residential downlight.
Trim shipped with a medium base socket adapter whip

LED LIGHT ENGINE

Cree true white® technology available
16w max.; Luminous efficacy of light source: 100lm/w
CRI>80, Color temperature: 3000K-5000K
Rated for 50000 hours at 70% lumen output

DRIVER

Dedicated 120 volt driver
Power factor >0.9
Dimmable to 10% with most brand dimmers
Rated for 50 to 60Hz at 120V/277V input
Produces less than 20% THD



ORDERING GUIDE / YOUR PRODUCT CODE ✓

SERIES	INPUT VOLTAGE	DIMMABLE
○ BL6-006 6" LED Downlight Wall Washer	○ 120V ○ 277V	○ Non-Dimmable ○ Dimmable
LUMEN OUTPUT	CCT	FINISH
○ 900 Lumen ○ 1200 Lumen	○ 3000K ○ 4000K ○ 5000K	○ White ○ Black ○ Satin Nickel
LED AVAILABLE		
○ Cree ○ Citizen	○ Epistar ○ Seoul	○ Osram

* Customized Also Available

BRL6-001-SF

6" LED DOWNLIGHT DEEP REFLECTOR RETROFIT



DESCRIPTION

Compatible with Liteharbor 6 inch recessed downlight
Designed to last a minimum 50,000 hours at L70
Dimmable to 10% with most brand dimmers
16w max.; Luminous efficacy of light source: 100lm/w

REFLECTOR

Reflector is high quality available in clear, semi diffuse or white finish.
Self flange trim is standard.

FEATURES

Deep set LED for superior glare and cut-off
Cree True White technology
Comprehensive solution with driver electronics, optics and core thermals
Versatile form factor for small-aperture designs
With integral power supply

MOUNTING

Spring clips safely secure LED trim and module to housing.



ORDERING GUIDE / YOUR PRODUCT CODE

SERIES	INPUT VOLTAGE	DIMMABLE
○ BRL6-001-SF 6" LED Downlight Deep Reflector	○ 120V ○ 277V	○ Non-Dimmable ○ Dimmable
LUMEN OUTPUT	CCT	LED AVAILABLE
○ 1100 Lumen ○ 1400 Lumen	○ 3000K ○ 4000K ○ 5000K	○ Cree ○ Citizen ○ Epistar ○ Seoul ○ Osram
FINISH	FINISH	LENS TYPE
○ Self Flanged ○ Self Flanged White	○ Clear ○ Haze ○ White	○ Clear Tempered ○ Sand Blasted

* Customized Also Available

BRL6-002-SF

6" LED DOWNLIGHT SHALLOW REFLECTOR RETROFIT



DESCRIPTION

Compatible with Liteharbor 6 inch recessed downlight
Designed to last a minimum 50,000 hours at L70
Dimmable to 10% with most brand dimmers
16w max.; Luminous efficacy of light source: 100lm/w

REFLECTOR

Reflector is high quality available in clear, semi diffuse or white finish.
Self flange trim is standard.

FEATURES

Deep set LED for superior glare and cut-off
Cree True White technology
Comprehensive solution with driver electronics, optics and core thermals
Versatile form factor for small-aperture designs
With integral power supply

MOUNTING

Spring clips safely secure LED trim and module to housing.



ORDERING GUIDE / YOUR PRODUCT CODE

SERIES	INPUT VOLTAGE	DIMMABLE
○ BRL6-002-SF 6" LED Downlight Shallow Reflector	○ 120V ○ 277V	○ Non-Dimmable ○ Dimmable
LUMEN OUTPUT	CCT	LED AVAILABLE
○ 1100 Lumen ○ 1400 Lumen	○ 3000K ○ 3000K ○ 4000K	○ Cree ○ Citizen ○ Epistar ○ Seoul ○ Osram
FINISH	FINISH	LENS TYPE
○ Self Flanged ○ Self Flanged White	○ Clear ○ Haze ○ White	○ Clear Tempered ○ Sand Blasted

* Customized Also Available

A3

3" NEW CONSTRUCTION NON-IC RECESSED HOUSING

DESCRIPTION

Housing must be kept at least 3" away from insulation
Can be installed in 1/2" to 1-3/8" thick ceilings
Includes adjustable hanger bars with integral nail
J-Box listed for through-branch circuit wiring (2 in-2 out or 4 in-4 out), five 1/2" knockouts and four romex knockouts with strain clamps
ETL listed for damp location W/Feed through

Lamp: LED 8W max. (See trim for max wattage)



A3-IA

3" NEW CONSTRUCTION AIRTIGHT IC RATED RECESSED HOUSING

DESCRIPTION

Designed for direct contact with insulation
Can be installed in 1/2" to 1-3/8" thick ceilings
Includes adjustable hanger bars with integral nail
J-Box listed for through-branch circuit wiring (2 in-2 out or 4 in-4 out), five 1/2" knockouts and four romex knockouts with strain clamps
ETL listed for damp location W/Feed through

Lamp: LED 8W max. (See trim for max wattage)

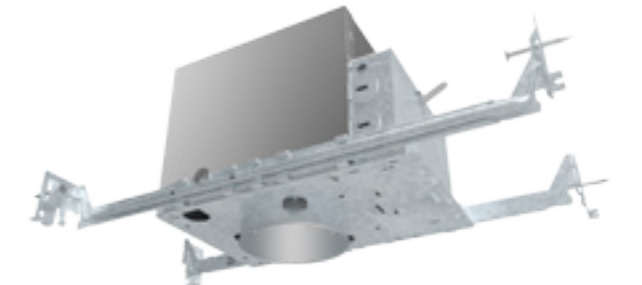

A3-R

3" REMODEL NON-IC RECESSED HOUSING

DESCRIPTION

Housing must be kept at least 3" away from insulation
Can be installed in 1/2" to 1-3/8" thick ceilings
Includes adjustable hanger bars with integral nail
J-Box listed for through-branch circuit wiring (4 in-4 out), five 1/2" knockouts and four romex knockouts with strain clamps
ETL listed for damp location W/Feed through

Lamp: LED 8W max. (See trim for max wattage)

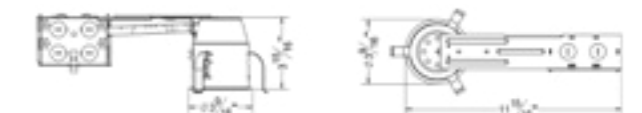

A3-R2

3" REMODEL NON-IC RECESSED HOUSING

DESCRIPTION

Housing must be kept at least 3" away from insulation
 Can be installed in 1/2" to 1-3/8" thick ceilings
 Includes adjustable hanger bars with integral nail
 J-Box listed for through-branch circuit wiring (2 in-2 out or 4 in-4 out), five 1/2" knockouts and four romex knockouts with strain clamps
 ETL listed for damp location W/Feed through



Lamp: LED 8W max. (See trim for max wattage)



A3-RJ

3" REMODEL NON-IC RECESSED HOUSING

DESCRIPTION

Housing must be kept at least 3" away from insulation
 Can be installed in 1/2" to 1-3/8" thick ceilings
 J-Box listed for through-branch circuit wiring (4 in-4 out), five 1/2" knockouts and four romex knockouts with strain clamps
 ETL listed for damp location W/Feed through



Lamp: LED 8W max. (See trim for max wattage)



A3-R2-04

3" REMODEL NON-IC RECESSED HOUSING

DESCRIPTION

Housing must be kept at least 3" away from insulation
 Can be installed in 1/2" to 1-3/8" thick ceilings
 J-Box listed for through-branch circuit wiring (4 in-4 out), five 1/2" knockouts and four romex knockouts with strain clamps
 ETL listed for damp location W/Feed through

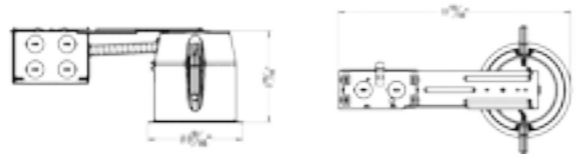

Lamp: LED 8W max. (See trim for max wattage)



A3-RCG

3" REMODEL NON-IC RECESSED HOUSING (CANADIAN STYLE)

DESCRIPTION

Housing must be kept at least 3" away from insulation
 Can be installed in 1/2" to 1-3/8" thick ceilings
 J-Box listed for through-branch circuit wiring (2 in-2 out or 4 in-4 out), five 1/2" knockouts and four romex knockouts with strain clamps
 ETL listed for damp location W/Feed through

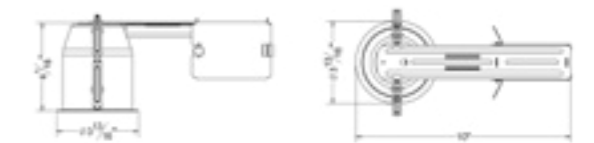

Lamp: LED 8W max. (See trim for max wattage)



A3-RD

3" REMODEL NON-IC RECESSED HOUSING

DESCRIPTION

Housing must be kept at least 3" away from insulation
 Can be installed in 1/2" to 1-3/8" thick ceilings
 J-Box listed for through-branch circuit wiring (2 in-2 out or 4 in-4 out), five 1/2" knockouts and four romex knockouts with strain clamps
 ETL listed for damp location W/Feed through



Lamp: LED 8W max. (See trim for max wattage)





B3001
3" Baffle Trim
Lamp: MR16 LED GU5.3 8W Max.
GU10 LED GU10 8W Max.
PAR16 LED E26 8W Max.



B3006
3" Wall Washer Trim
Lamp: MR16 LED GU5.3 8W Max.
GU10 LED GU10 8W Max.
PAR16 LED E26 8W Max.



B3802
3" Shower Trim with Frosted Lens
Lamp: MR16 LED GU5.3 6W Max.
GU10 LED GU10 6W Max.
PAR16 LED E26 6W Max.
Gasket used to prevent moisture
Wet location listed



BS3002
3" Square Reflector Trim
Lamp: MR16 LED GU5.3 8W Max.
GU10 LED GU10 8W Max.
PAR16 LED E26 8W Max.



BS3001
3" Square Baffle Trim
Lamp: MR16 LED GU5.3 8W Max.
GU10 LED GU10 8W Max.
PAR16 LED E26 8W Max.



B3002
3" Reflector Trim
Lamp: MR16 LED GU5.3 8W Max.
GU10 LED GU10 8W Max.
PAR16 LED E26 8W Max.



B3007
3" Gimbal Ring Trim
Lamp: MR16 LED GU5.3 8W Max.
GU10 LED GU10 8W Max.
PAR16 LED E26 8W Max.



B3008
3" Gimbal Trim
Lamp: MR16 LED GU5.3 8W Max.
GU10 LED GU10 8W Max.
PAR16 LED E26 8W Max.



B3011
3" Square Trim
Lamp: MR16 LED GU5.3 8W Max.
GU10 LED GU10 8W Max.
PAR16 LED E26 8W Max.



BS3007
3" Square Gimbal Trim
Lamp: MR16 LED GU5.3 8W Max.
GU10 LED GU10 8W Max.
PAR16 LED E26 8W Max.

ORDERING GUIDE ✓
YOUR PRODUCT CODE

SERIES

- B3_____
 - BS3_____
- 3 Inch Trim

RING FINISH

- White Matte
- White Shining
- Black Matte
- Black Shining
- Oil Rubbed Brown
- Grey
- Satin Nickel
- Chrome
- Polished Brass
- Mocha
- Golden

BAFFLE/REFLECTOR FINISH

- Clear
- Haze
- Champagne
- White Matte
- White Shining
- Black Matte
- Black Shining
- Oil Rubbed Brown
- Grey
- Satin Nickel
- Chrome
- Polished Brass
- Mocha
- Golden

* Customized Also Available

A35

3.5" NEW CONSTRUCTION NON-IC RECESSED HOUSING

DESCRIPTION
Housing must be kept at least 3" away from insulation
Can be installed in 1/2" to 1-3/8" thick ceilings
Includes adjustable hanger bars with integral nail
J-Box listed for through-branch circuit wiring (4 in-4 out), five 1/2" knockouts and four romex knockouts with strain clamps
ETL listed for damp location W/Feed through

Lamp: LED 8W max. (See trim for max wattage) 

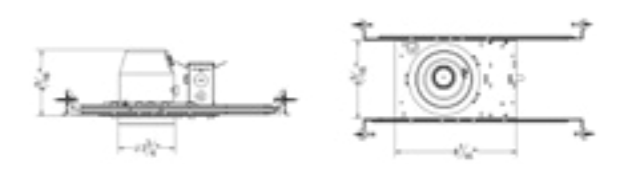
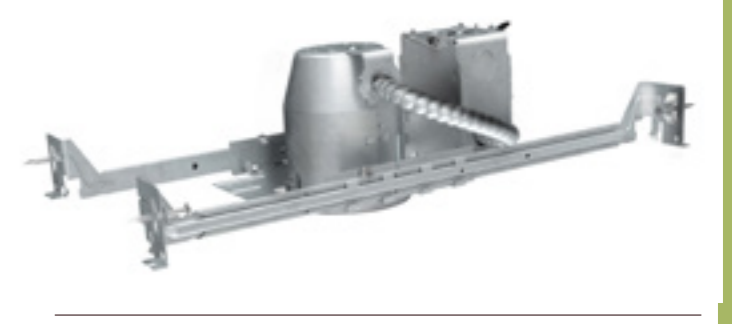

A35-IA

3.5" NEW CONSTRUCTION AIRTIGHT IC RATED RECESSED HOUSING

DESCRIPTION
Designed for direct contact with insulation
Can be installed in 1/2" to 1-3/8" thick ceilings
Includes adjustable hanger bars with integral nail
J-Box listed for through-branch circuit wiring (4 in-4 out), five 1/2" knockouts and four romex knockouts with strain clamps
ETL listed for damp location W/Feed through

Lamp: LED 8W max. (See trim for max wattage) 

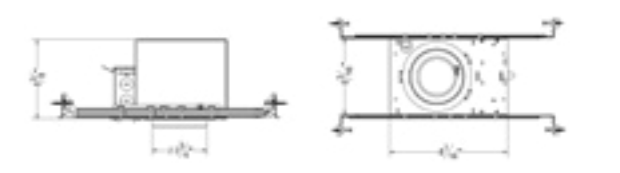
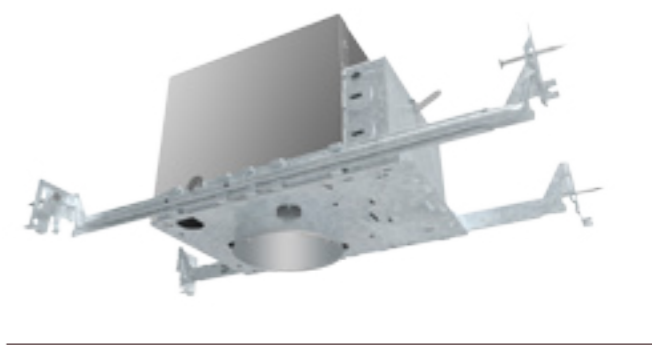

A35-R

3.5" REMODEL NON-IC RECESSED HOUSING

DESCRIPTION
Housing must be kept at least 3" away from insulation
Can be installed in 1/2" to 1-3/8" thick ceilings
J-Box listed for through-branch circuit wiring (4 in-4 out), five 1/2" knockouts and four romex knockouts with strain clamps
ETL listed for damp location W/Feed through

Lamp: LED 8W max. (See trim for max wattage) 

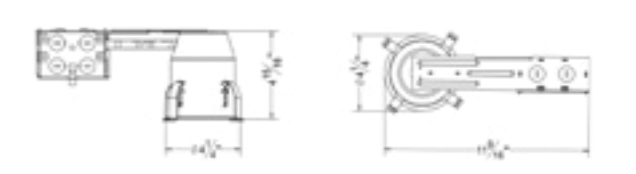

A35-R2

3.5" REMODEL NON-IC RECESSED HOUSING

DESCRIPTION

Housing must be kept at least 3" away from insulation
 Can be installed in 1/2" to 1-3/8" thick ceilings
 J-Box listed for through-branch circuit wiring (4 in-4 out), five 1/2" knockouts and four romex knockouts with strain clamps
 ETL listed for damp location W/Feed through

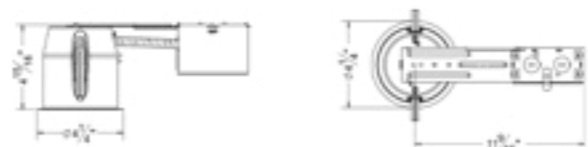

Lamp: LED 8W max. (See trim for max wattage)



A35-RJ

3.5" Remodel NON-IC Recessed Housing

DESCRIPTION

Housing must be kept at least 3" away from insulation
 Can be installed in 1/2" to 1-3/8" thick ceilings
 J-Box listed for through-branch circuit wiring (4 in-4 out), five 1/2" knockouts and four romex knockouts with strain clamps
 ETL listed for damp location W/Feed through



Lamp: LED 8W max. (See trim for max wattage)



A35-R2-04

3.5" REMODEL NON-IC RECESSED HOUSING

DESCRIPTION

Housing must be kept at least 3" away from insulation
 Can be installed in 1/2" to 1-3/8" thick ceilings
 J-Box listed for through-branch circuit wiring (4 in-4 out), five 1/2" knockouts and four romex knockouts with strain clamps
 ETL listed for damp location W/Feed through

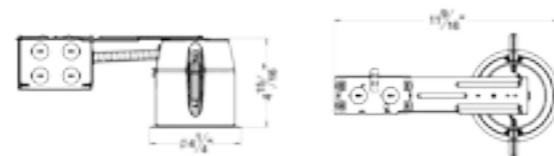

Lamp: LED 8W max. (See trim for max wattage)



A35-RCG

3.5" REMODEL NON-IC RECESSED HOUSING

DESCRIPTION

Housing must be kept at least 3" away from insulation
 Can be installed in 1/2" to 1-3/8" thick ceilings
 J-Box listed for through-branch circuit wiring (2 in-2 out or 4 in-4 out), five 1/2" knockouts and four romex knockouts with strain clamps
 ETL listed for damp location W/Feed through



Lamp: LED 8W max. (See trim for max wattage)



A35-RD

3.5" REMODEL NON-IC RECESSED HOUSING

DESCRIPTION

Housing must be kept at least 3" away from insulation
 Can be installed in 1/2" to 1-3/8" thick ceilings
 J-Box listed for through-branch circuit wiring (2 in-2 out or 4 in-4 out), five 1/2" knockouts and four romex knockouts with adjustable clamps
 ETL listed for damp location W/Feed through



Lamp: LED 8W max. (See trim for max wattage)





B35001
3.5" Baffle Trim
Lamp: MR16 LED GU5.3 8W Max.
GU10 LED GU10 8W Max.
PAR16 LED E26 8W Max.



B35003
3.5" Eyeball Trim
Lamp: MR16 LED GU5.3 8W Max.
GU10 LED GU10 8W Max.
PAR16 LED E26 8W Max.



B35014
3.5" Pinhole Trim
Lamp: MR16 LED GU5.3 8W Max.
GU10 LED GU10 8W Max.
PAR16 LED E26 8W Max.



B35071
3.5" Large Gimbal Trim
Lamp: MR16 LED GU5.3 8W Max.
GU10 LED GU10 8W Max.
PAR16 LED E26 8W Max.



B35802
3.5" Shower Trim with Frosted Lens
Lamp: MR16 LED GU5.3 6W Max.
GU10 LED GU10 6W Max.
PAR16 LED E26 6W Max.
Gasket used to prevent moisture
Wet location listed



BS35001
3.5" Square Baffle Trim
Lamp: MR16 LED GU5.3 8W Max.
GU10 LED GU10 8W Max.
PAR16 LED E26 8W Max.



BS35002
3.5" Square Reflector Trim
Lamp: MR16 LED GU5.3 8W Max.
GU10 LED GU10 8W Max.
PAR16 LED E26 8W Max.



B35002
3.5" Reflector Trim
Lamp: MR16 LED GU5.3 8W Max.
GU10 LED GU10 8W Max.
PAR16 LED E26 8W Max.



B35005
3.5" Slot Trim
Lamp: MR16 LED GU5.3 8W Max.
GU10 LED GU10 8W Max.
PAR16 LED E26 8W Max.



B35024
3.5" Reflector Adjustable Trim
Lamp: MR16 LED GU5.3 8W Max.
GU10 LED GU10 8W Max.
PAR16 LED E26 8W Max.



B35602
3.5" Shower Trim with Dome Lens
Lamp: MR16 LED GU5.3 6W Max.
GU10 LED GU10 6W Max.
PAR16 LED E26 6W Max.
Gasket used to prevent moisture
Wet location listed



B35011
3.5" Square Baffle Trim
Lamp: MR16 LED GU5.3 8W Max.
GU10 LED GU10 8W Max.
PAR16 LED E26 8W Max.



BS35007
3.5" Square Gimbal Trim
Lamp: MR16 LED GU5.3 8W Max.
GU10 LED GU10 8W Max.
PAR16 LED E26 8W Max.

ORDERING GUIDE ✓
YOUR PRODUCT CODE

SERIES

- B35 _____
- BS35 _____
- 3.5 Inch Trim

RING FINISH

- White Matte
- White Shining
- Black Matte
- Black Shining
- Oil Rubbed Brown
- Grey
- Satin Nickel
- Chrome
- Polished Brass
- Mocha
- Golden

BAFFLE/REFLECTOR FINISH

- Clear
- Haze
- Champagne
- White Matte
- White Shining
- Black Matte
- Black Shining
- Oil Rubbed Brown
- Grey
- Satin Nickel
- Chrome
- Polished Brass
- Mocha
- Golden

* Customized Also Available

A4

**4" NEW CONSTRUCTION
NON-IC RECESSED HOUSING**

DESCRIPTION

Housing must be kept at least 3" away from insulation
Can be installed in 1/2" to 1-3/8" thick ceilings
Includes adjustable hanger bars with integral nail
J-Box listed for through-branch circuit wiring (4 in-4 out), five 1/2" knockouts
and four romex knockouts with strain clamps
ETL listed for damp location W/Feed through

Lamp: LED 10W max. (See trim for max wattage)

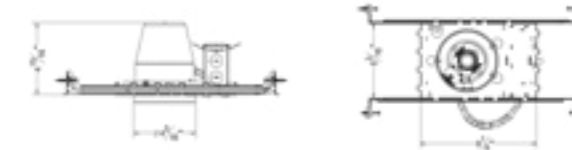

A4-IA

**4" NEW CONSTRUCTION
AIRTIGHT IC RATED
RECESSED HOUSING**

DESCRIPTION

Designed for direct contact with insulation
Can be installed in 1/2" to 1-3/8" thick ceilings
Includes adjustable hanger bars with integral nail
J-Box listed for through-branch circuit wiring (4 in-4 out), five 1/2" knockouts
and four romex knockouts with strain clamps
ETL listed for damp location W/Feed through

Lamp: LED 10W max. (See trim for max wattage)

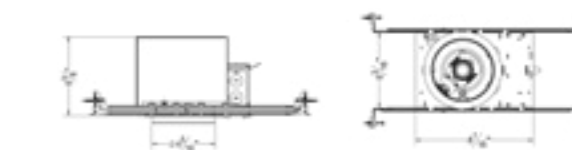

A4-R

**4" REMODEL NON-IC
RECESSED HOUSING**

DESCRIPTION

Housing must be kept at least 3" away from insulation
Can be installed in 1/2" to 1-3/8" thick ceilings
J-Box listed for through-branch circuit wiring (4 in-4 out), five 1/2" knockouts
and four romex knockouts with strain clamps
ETL listed for damp location W/Feed through

Lamp: LED 10W max. (See trim for max wattage)



A4-R2

4" REMODEL NON-IC RECESSED HOUSING (CANADIAN STYLE)

DESCRIPTION

Housing must be kept at least 3" away from insulation
 Can be installed in 1/2" to 1-3/8" thick ceilings
 J-Box listed for through-branch circuit wiring (4 in-4 out), five 1/2" knockouts and four romex knockouts with strain clamps
 ETL listed for damp location W/Feed through

Lamp: LED 10W max. (See trim for max wattage)

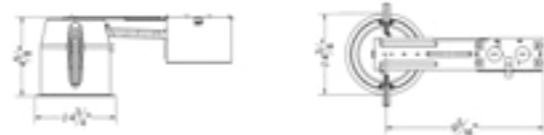

A4-RJ

4" REMODEL NON-IC RECESSED HOUSING

DESCRIPTION

Housing must be kept at least 3" away from insulation
 Can be installed in 1/2" to 1-3/8" thick ceilings
 J-Box listed for through-branch circuit wiring (4 in-4 out), five 1/2" knockouts and four romex knockouts with strain clamps
 ETL listed for damp location W/Feed through

Lamp: LED 10W max. (See trim for max wattage)

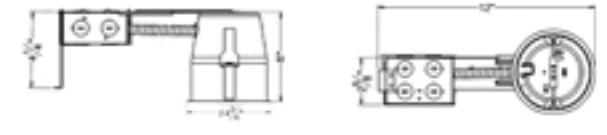

A4-R2-04

4" REMODEL NON-IC RECESSED HOUSING

DESCRIPTION

Housing must be kept at least 3" away from insulation
 Can be installed in 1/2" to 1-3/8" thick ceilings
 J-Box listed for through-branch circuit wiring (4 in-4 out), five 1/2" knockouts and four romex knockouts with strain clamps
 ETL listed for damp location W/Feed through

Lamp: LED 10W max. (See trim for max wattage)

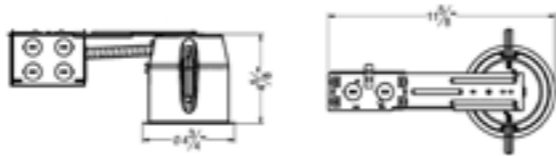

A4-RCG

4" REMODEL NON-IC RECESSED HOUSING

DESCRIPTION

Housing must be kept at least 3" away from insulation
 Can be installed in 1/2" to 1-3/8" thick ceilings
 J-Box listed for through-branch circuit wiring (2 in-2 out or 4 in-4 out), five 1/2" knockouts and four romex knockouts with strain clamps
 ETL listed for damp location W/Feed through

Lamp: LED 10W max. (See trim for max wattage)



A4-RD

4" REMODEL NON-IC RECESSED HOUSING

DESCRIPTION

Housing must be kept at least 3" away from insulation
 Can be installed in 1/2" to 1-3/8" thick ceilings
 J-Box listed for through-branch circuit wiring (2 in-2 out or 4 in-4 out), five 1/2" knockouts and four romex knockouts with strain clamps
 ETL listed for damp location W/Feed through

Lamp: LED 10W max. (See trim for max wattage)





B4001
4" Baffle Trim
Lamp: R20/PAR20 LED E26 10W Max.



B4003
4" Eyeball Trim
Lamp: R20/PAR20 LED E26 10W Max.



B4012
4" Gimbal Trim
Lamp: R20/PAR20 LED E26 10W Max.



B4302
4" Shower Reflector Trim with Fresnel Lens
Lamp: R20/PAR20 LED E26 8W Max.
Gasket used to prevent moisture
Wet location listed

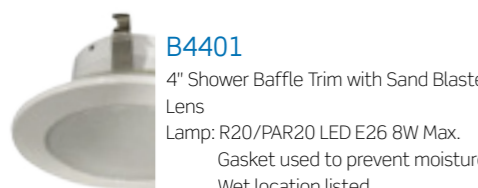

B4401
4" Shower Baffle Trim with Sand Blasted Lens
Lamp: R20/PAR20 LED E26 8W Max.
Gasket used to prevent moisture
Wet location listed

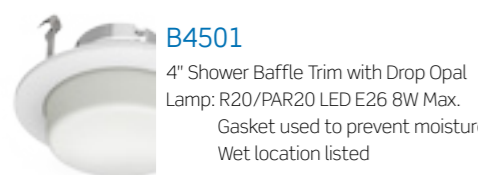

B4501
4" Shower Baffle Trim with Drop Opal
Lamp: R20/PAR20 LED E26 8W Max.
Gasket used to prevent moisture
Wet location listed

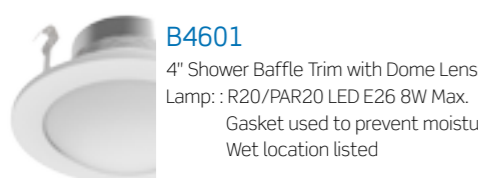

B4601
4" Shower Baffle Trim with Dome Lens
Lamp: R20/PAR20 LED E26 8W Max.
Gasket used to prevent moisture
Wet location listed



B4002
4" Reflector Trim
Lamp: R20/PAR20 LED E26 10W Max.



B4007
4" Large Gimbal Trim
Lamp: R20/PAR20 LED E26 10W Max.

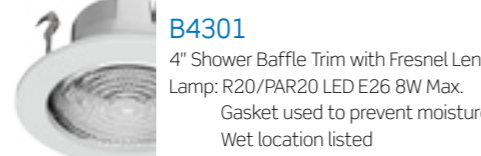

B4301
4" Shower Baffle Trim with Fresnel Lens
Lamp: R20/PAR20 LED E26 8W Max.
Gasket used to prevent moisture
Wet location listed

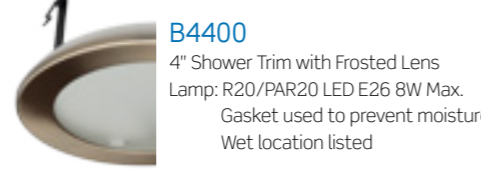

B4400
4" Shower Trim with Frosted Lens
Lamp: R20/PAR20 LED E26 8W Max.
Gasket used to prevent moisture
Wet location listed



B4402
4" Shower Reflector Trim with Sand Blasted Lens
Lamp: R20/PAR20 LED E26 8W Max.
Gasket used to prevent moisture
Wet location listed



B4502
4" Shower Reflector Trim with Drop Opal
Lamp: R20/PAR20 LED E26 8W Max.
Gasket used to prevent moisture
Wet location listed

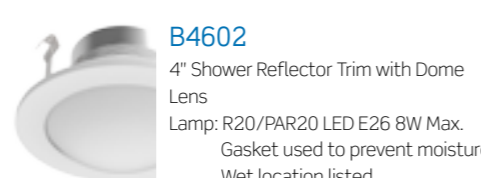

B4602
4" Shower Reflector Trim with Dome Lens
Lamp: R20/PAR20 LED E26 8W Max.
Gasket used to prevent moisture
Wet location listed

ORDERING GUIDE ✓
YOUR PRODUCT CODE

SERIES

- B4_____
- 4 Inch Trim

RING FINISH

- White Matte
- White Shining
- Black Matte
- Black Shining
- Oil Rubbed Brown
- Grey
- Satin Nickel
- Chrome
- Polished Brass
- Mocha
- Golden

BAFFLE/REFLECTOR FINISH

- Clear
- Haze
- Champagne
- White Matte
- White Shining
- Black Matte
- Black Shining
- Oil Rubbed Brown
- Grey
- Satin Nickel
- Chrome
- Polished Brass
- Mocha
- Golden

* Customized Also Available

ORDERING GUIDE ✓
YOUR PRODUCT CODE

SERIES

- B4_____
- BD4_____
- 4 Inch Trim

RING FINISH

- White Matte
- White Shining
- Black Matte
- Black Shining
- Oil Rubbed Brown
- Grey
- Satin Nickel
- Chrome
- Polished Brass
- Mocha
- Golden

BAFFLE/REFLECTOR FINISH

- Clear
- Haze
- Champagne
- White Matte
- White Shining
- Black Matte
- Black Shining
- Oil Rubbed Brown
- Grey
- Satin Nickel
- Chrome
- Polished Brass
- Mocha
- Golden

* Customized Also Available



B4701
4" Shower Baffle Trim with Frosted Lens
Lens Clear in Centre
Lamp: R20/PAR20 LED E26 8W Max.
Gasket used to prevent moisture
Wet location listed

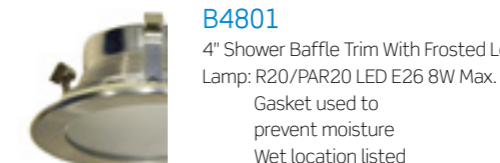

B4801
4" Shower Baffle Trim With Frosted Lens
Lamp: R20/PAR20 LED E26 8W Max.
Gasket used to prevent moisture
Wet location listed



BD4002
4" Reflector Trim
Lamp: MR16 LED GU5.3 10W Max.
GU10 LED GU10 10W Max.
PAR16 LED E26 10W Max.



BD4004
4" Pinhole Trim
Lamp: MR16 LED GU5.3 10W Max.
GU10 LED GU10 10W Max.
PAR16 LED E26 10W Max.



BD4005
4" Slot Trim
Lamp: MR16 LED GU5.3 10W Max.
GU10 LED GU10 10W Max.
PAR16 LED E26 10W Max.



BD4007L
4" Large Gimbal Ring Trim
Lamp: MR16 LED GU5.3 10W Max.
GU10 LED GU10 10W Max.
PAR16 LED E26 10W Max.



BD4009
4" Large Regress Rotating Eyeball Trim
Lamp: MR16 LED GU5.3 10W Max.
GU10 LED GU10 10W Max.
PAR16 LED E26 10W Max.



B4702
4" Shower Reflector Trim with Frosted Lens
Lens Clear in Centre
Lamp: R20/PAR20 LED E26 8W Max.
Gasket used to prevent moisture
Wet location listed



BD4001
4" Baffle Trim
Lamp: MR16 LED GU5.3 10W Max.
GU10 LED GU10 10W Max.
PAR16 LED E26 10W Max.

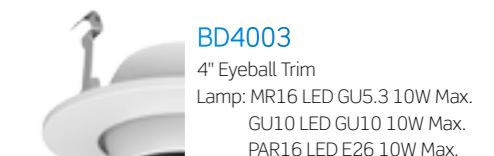

BD4003
4" Eyeball Trim
Lamp: MR16 LED GU5.3 10W Max.
GU10 LED GU10 10W Max.
PAR16 LED E26 10W Max.



BD4004L
4" Large Pinhole Trim
Lamp: MR16 LED GU5.3 10W Max.
GU10 LED GU10 10W Max.
PAR16 LED E26 10W Max.



BD4007
4" Gimbal Ring Trim
Lamp: MR16 LED GU5.3 10W Max.
GU10 LED GU10 10W Max.
PAR16 LED E26 10W Max.



BD4012
4" Gimbal Trim
Lamp: MR16 LED GU5.3 10W Max.
GU10 LED GU10 10W Max.
PAR16 LED E26 10W Max.



BD4010
4" Retractable Trim
Lamp: MR16 LED GU5.3 10W Max.
GU10 LED GU10 10W Max.
PAR16 LED E26 10W Max.

BD4014
4" Large Pinhole Trim
Lamp: MR16 LED GU5.3 10W Max.
GU10 LED GU10 10W Max.
PAR16 LED E26 10W Max.

BD4016
4" Wall Wash Trim
Lamp: MR16 LED GU5.3 10W Max.
GU10 LED GU10 10W Max.
PAR16 LED E26 10W Max.

BD4022
4" Accent Angle Cut Reflector Trim
Lamp: MR16 LED GU5.3 10W Max.
GU10 LED GU10 10W Max.
PAR16 LED E26 10W Max.

BD4026
4" Wall Wash Trim with Reflector
Lamp: MR16 LED GU5.3 10W Max.
GU10 LED GU10 10W Max.
PAR16 LED E26 10W Max.

BD4302
4" Shower Reflector Trim with Fresnel Lens
Lamp: MR16 LED GU5.3 8W Max.
GU10 LED GU10 8W Max.
PAR16 LED E26 8W Max.
Gasket used to prevent moisture
Wet location listed

BD4401
4" Shower Baffle Trim with Albalite
Lamp: MR16 LED GU5.3 8W Max.
GU10 LED GU10 8W Max.
PAR16 LED E26 8W Max.
Gasket used to prevent moisture
Wet location listed

BD4501
4" Shower Baffle Trim with Drop opal
Lamp: MR16 LED GU5.3 8W Max.
GU10 LED GU10 8W Max.
PAR16 LED E26 8W Max.
Gasket used to prevent moisture
Wet location listed

BD4015
4" Slot Baffle Trim
Lamp: MR16 LED GU5.3 10W Max.
GU10 LED GU10 10W Max.
PAR16 LED E26 10W Max.

BD4024
4" Pinhole Reflector Trim
Lamp: MR16 LED GU5.3 10W Max.
GU10 LED GU10 10W Max.
PAR16 LED E26 10W Max.

BD4025
4" Slot Trim with Reflector
Lamp: MR16 LED GU5.3 10W Max.
GU10 LED GU10 10W Max.
PAR16 LED E26 10W Max.

BD4301
4" Shower Baffle Trim with Fresnel Lens
Lamp: MR16 LED GU5.3 8W Max.
GU10 LED GU10 8W Max.
PAR16 LED E26 8W Max.
Gasket used to prevent moisture
Wet location listed

BD4326
4" Wall Washer Reflector Trim with Spread Lens 40° Adjustment
Lamp: MR16 LED GU5.3 8W Max.
GU10 LED GU10 8W Max.
PAR16 LED E26 8W Max.
Gasket used to prevent moisture
Wet location listed

BD4402
4" Shower Reflector Trim with Albalite
Lamp: MR16 LED GU5.3 8W Max.
GU10 LED GU10 8W Max.
PAR16 LED E26 8W Max.
Gasket used to prevent moisture
Wet location listed

BD4502
4" Shower Reflector Trim with Drop opal
Lamp: MR16 LED GU5.3 8W Max.
GU10 LED GU10 8W Max.
PAR16 LED E26 8W Max.
Gasket used to prevent moisture
Wet location listed

ORDERING GUIDE ✓
YOUR PRODUCT CODE

SERIES

- BD4_____
- 4 Inch Trim

RING FINISH

- White Matte
- White Shining
- Black Matte
- Black Shining
- Oil Rubbed Brown
- Grey
- Satin Nickel
- Chrome
- Polished Brass
- Mocha
- Golden

BAFFLE/REFLECTOR FINISH

- Clear
- Haze
- Champagne
- White Matte
- White Shining
- Black Matte
- Black Shining
- Oil Rubbed Brown
- Grey
- Satin Nickel
- Chrome
- Polished Brass
- Mocha
- Golden

* Customized Also Available

ORDERING GUIDE ✓
YOUR PRODUCT CODE

SERIES

- BD4_____
- BS4_____
- 4 Inch Trim

RING FINISH

- White Matte
- White Shining
- Black Matte
- Black Shining
- Oil Rubbed Brown
- Grey
- Satin Nickel
- Chrome
- Polished Brass
- Mocha
- Golden

BAFFLE/REFLECTOR FINISH

- Clear
- Haze
- Champagne
- White Matte
- White Shining
- Black Matte
- Black Shining
- Oil Rubbed Brown
- Grey
- Satin Nickel
- Chrome
- Polished Brass
- Mocha
- Golden

* Customized Also Available

BD4601
4" Shower Baffle Trim with Dome Lens
Lamp: MR16 LED GU5.3 8W Max.
GU10 LED GU10 8W Max.
PAR16 LED E26 8W Max.
Gasket used to prevent moisture
Wet location listed

BD4701
4" Shower Baffle Trim with Frosted Lens Clear in Centre
Lamp: MR16 LED GU5.3 8W Max.
GU10 LED GU10 8W Max.
PAR16 LED E26 8W Max.
Gasket used to prevent moisture
Wet location listed

BD4801
4" Shower Baffle Trim with Frosted Lens
Lamp: MR16 LED GU5.3 8W Max.
GU10 LED GU10 8W Max.
PAR16 LED E26 8W Max.
Gasket used to prevent moisture
Wet location listed

B4802
4" Shower Reflector Trim With Frosted Lens
Lamp: R20/PAR20 LED E26 8W Max.
Gasket used to prevent moisture
Wet location listed

B4011
4" Square Baffle Trim
Lamp: R20/PAR20 LED E26 10W Max.

BS4002
4" Square Reflector Trim
Lamp: R20/PAR20 LED E26 10W Max.

BS4301
4" Square Shower Baffle Trim with Fresnel Lens
Lamp: R20/PAR20 LED E26 8W Max.
Gasket used to prevent moisture
Wet location listed

BD4602
4" Shower Reflector Trim with Dome Lens
Lamp: MR16 LED GU5.3 8W Max.
GU10 LED GU10 8W Max.
PAR16 LED E26 8W Max.
Gasket used to prevent moisture
Wet location listed

BD4702
4" Shower Reflector Trim with Frosted Lens Clear in Centre
Lamp: MR16 LED GU5.3 8W Max.
GU10 LED GU10 8W Max.
PAR16 LED E26 8W Max.
Gasket used to prevent moisture
Wet location listed

BD4802
4" Shower Reflector Trim with Frosted Lens
Lamp: MR16 LED GU5.3 8W Max.
GU10 LED GU10 8W Max.
PAR16 LED E26 8W Max.
Gasket used to prevent moisture
Wet location listed

BD4902
4" Clear Reflector Trim with Drop Glass
Lamp: MR16 LED GU5.3 8W Max.
GU10 LED GU10 8W Max.
PAR16 LED E26 8W Max.
Gasket used to prevent moisture
Wet location listed

BS4001
4" Square Baffle Trim
Lamp: R20/PAR20 LED E26 10W Max.

BS4007
4" Square Gimbal Trim
Lamp: R20/PAR20 LED E26 8W Max.

BS4302
4" Square Shower Reflector Trim with Fresnel Lens
Lamp: R20/PAR20 LED E26 8W Max.
Gasket used to prevent moisture
Wet location listed



BS4401
4" Square Shower Baffle Trim with Albalite Lens
Lamp: R20/PAR20 LED E26 8W Max.
Gasket used to prevent moisture
Wet location listed



BS4701
4" Square Shower Baffle Trim with Frosted Lens Clear in Centre
Lamp: R20/PAR20 LED E26 10W Max.
Gasket used to prevent moisture
Wet location listed



BS4801
4" Square Shower Baffle Trim with Frosted Lens
Lamp: R20/PAR20 LED E26 10W Max.
Gasket used to prevent moisture
Wet location listed



BD4011
4" Square Baffle Trim
Lamp: MR16 LED GU5.3 10W Max.
GU10 LED GU10 10W Max.
PAR16 LED E26 10W Max.



BDS4001
4" Square Baffle Trim
Lamp: MR16 LED GU5.3 8W Max.
GU10 LED GU10 8W Max.
PAR16 LED E26 8W Max.



BDS4007
4" Square Gimbal Trim
Lamp: MR16 LED GU5.3 8W Max.
GU10 LED GU10 8W Max.
PAR16 LED E26 8W Max.



BDS4302
4" Square Reflector Trim with Fresnel Lens
Lamp: MR16 LED GU5.3 8W Max.
GU10 LED GU10 8W Max.
PAR16 LED E26 8W Max.
Gasket used to prevent moisture
Wet location listed



BS4402
4" Square Reflector Trim with Albalite Lens
Lamp: R20/PAR20 LED E26 10W Max.
Gasket used to prevent moisture
Wet location listed



BS4702
4" Square Shower Reflector Trim with Frosted Lens Clear in Centre
Lamp: R20/PAR20 LED E26 8W Max.
Gasket used to prevent moisture
Wet location listed



BS4802
4" Square Shower Reflector Trim with Frosted Lens
Lamp: R20/PAR20 LED E26 10W Max.
Gasket used to prevent moisture
Wet location listed



BD4017
4" Square Retractable Trim
Lamp: MR16 LED GU5.3 10W Max.
GU10 LED GU10 10W Max.
PAR16 LED E26 10W Max.



BDS4002
4" Square Reflector Trim
Lamp: MR16 LED GU5.3 8W Max.
GU10 LED GU10 8W Max.
PAR16 LED E26 8W Max.



BDS4301
4" Square Shower Baffle Trim with Fresnel Lens
Lamp: MR16 LED GU5.3 8W Max.
GU10 LED GU10 8W Max.
PAR16 LED E26 8W Max.
Gasket used to prevent moisture
Wet location listed



BDS4401
4" Square Shower Baffle Trim with Albalite Lens
Lamp: MR16 LED GU5.3 8W Max.
GU10 LED GU10 8W Max.
PAR16 LED E26 8W Max.
Gasket used to prevent moisture
Wet location listed

ORDERING GUIDE ✓
YOUR PRODUCT CODE

SERIES

- BD4_____
- BS4_____
- BDS4_____
- 4 Inch Trim

RING FINISH

- White Matte
- White Shining
- Black Matte
- Black Shining
- Oil Rubbed Brown
- Grey
- Satin Nickel
- Chrome
- Polished Brass
- Mocha
- Golden

BAFFLE/REFLECTOR FINISH

- Clear
- Haze
- Champagne
- White Matte
- White Shining
- Black Matte
- Black Shining
- Oil Rubbed Brown
- Grey
- Satin Nickel
- Chrome
- Polished Brass
- Mocha
- Golden

* Customized Also Available

ORDERING GUIDE ✓
YOUR PRODUCT CODE

SERIES

- BDS4_____
- 4 Inch Trim

RING FINISH

- White Matte
- White Shining
- Black Matte
- Black Shining
- Oil Rubbed Brown
- Grey
- Satin Nickel
- Chrome
- Polished Brass
- Mocha
- Golden

BAFFLE/REFLECTOR FINISH

- Clear
- Haze
- Champagne
- White Matte
- White Shining
- Black Matte
- Black Shining
- Oil Rubbed Brown
- Grey
- Satin Nickel
- Chrome
- Polished Brass
- Mocha
- Golden

* Customized Also Available



BDS4402
4" Square Shower Reflector Trim with Albalite Lens
Lamp: MR16 LED GU5.3 8W Max.
GU10 LED GU10 8W Max.
PAR16 LED E26 8W Max.
Gasket used to prevent moisture
Wet location listed



BDS4702
4" Square Shower Reflector Trim with Frosted Lens Clear in Centre
Lamp: MR16 LED GU5.3 8W Max.
GU10 LED GU10 8W Max.
PAR16 LED E26 8W Max.
Gasket used to prevent moisture
Wet location listed



BDS4802
4" Square Shower Reflector Trim with Frosted Lens
Lamp: MR16 LED GU5.3 8W Max.
GU10 LED GU10 8W Max.
PAR16 LED E26 8W Max.
Gasket used to prevent moisture
Wet location listed



BDS4701
4" Square Shower Baffle Trim with Frosted Lens Clear in Centre
Lamp: MR16 LED GU5.3 8W Max.
GU10 LED GU10 8W Max.
PAR16 LED E26 8W Max.
Gasket used to prevent moisture
Wet location listed



BDS4801
4" Square Shower Baffle Trim with Frosted Lens
Lamp: MR16 LED GU5.3 8W Max.
GU10 LED GU10 8W Max.
PAR16 LED E26 8W Max.
Gasket used to prevent moisture
Wet location listed

A5

5" NEW CONSTRUCTION NON-IC RECESSED HOUSING

DESCRIPTION

Housing must be kept at least 3" away from insulation
 Can be installed in 1/2" to 1-3/8" thick ceilings
 Includes adjustable hanger bars with integral nail
 J-Box listed for through-branch circuit wiring (4 in-4 out), five 1/2" knockouts
 and four romex knockouts with strain clamps
 ETL listed for damp location W/Feed through

Lamp: LED 18W max. (See trim for max wattage)

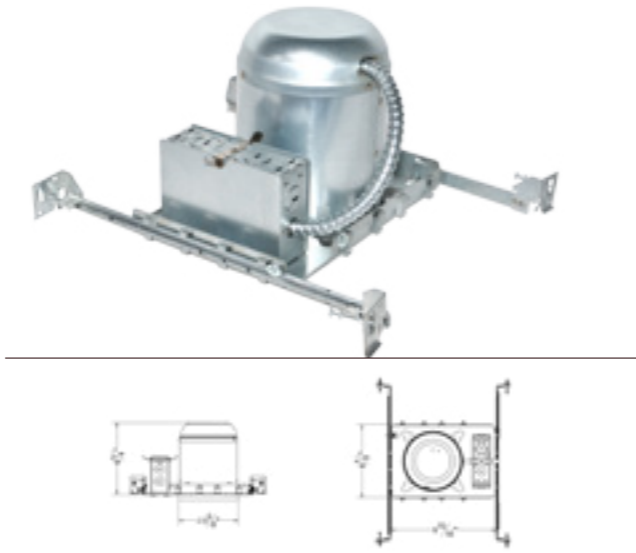

A5-RIA

5" REMODEL AIRTIGHT IC RATED RECESSED HOUSING

DESCRIPTION

Designed for direct contact with insulation
 Can be installed in 1/2" to 1-3/8" thick ceilings
 J-Box listed for through-branch circuit wiring (4 in-4 out), five 1/2" knockouts
 and four romex knockouts with strain clamps
 ETL listed for damp location W/Feed through

Lamp: LED 18W max. (See trim for max wattage)



A5-R

5" REMODEL NON-IC RECESSED HOUSING

DESCRIPTION

Housing must be kept at least 3" away from insulation
 Can be installed in 1/2" to 1-3/8" thick ceilings
 J-Box listed for through-branch circuit wiring (4 in-4 out), five 1/2" knockouts
 and four romex knockouts with strain clamps
 ETL listed for damp location W/Feed through

Lamp: LED 18W max. (See trim for max wattage)



A5-IA

5" NEW CONSTRUCTION AIRTIGHT IC RATED RECESSED HOUSING

DESCRIPTION

Designed for direct contact with insulation
 Can be installed in 1/2" to 1-3/8" thick ceilings
 Includes adjustable hanger bars with integral nail
 J-Box listed for through-branch circuit wiring (4 in-4 out), five 1/2" knockouts
 and four romex knockouts with strain clamps
 ETL listed for damp location W/Feed through

Lamp: LED 18W max. (See trim for max wattage)

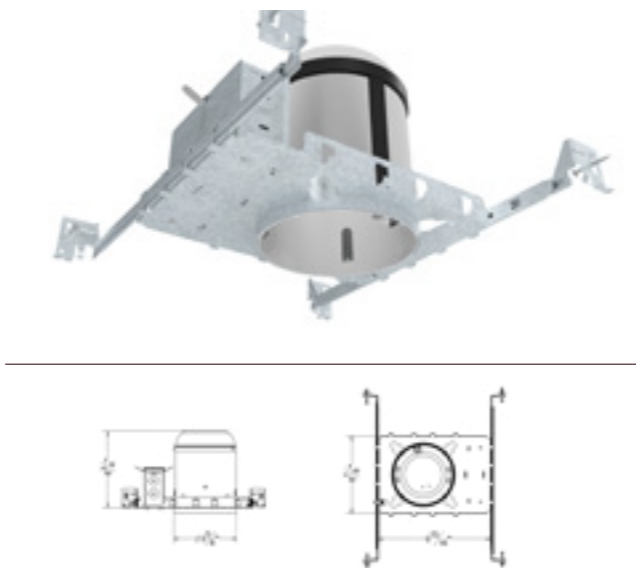

ORDERING GUIDE

YOUR PRODUCT CODE

SERIES

- B5 _____
5 Inch Trim

RING FINISH

- White Matte
- White Shining
- Black Matte
- Black Shining
- Oil Rubbed Brown
- Grey
- Satin Nickel
- Chrome
- Polished Brass
- Mocha
- Golden

BAFFLE/REFLECTOR FINISH

- Clear
- Haze
- Champagne
- White Matte
- White Shining
- Black Matte
- Black Shining
- Oil Rubbed Brown
- Grey
- Satin Nickel
- Chrome
- Polished Brass
- Mocha
- Golden

* Customized Also Available



B5001
5" Baffle Trim
Lamp: R30/PAR30 LED E26 18W Max.

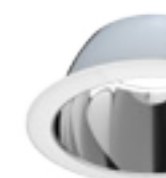

B5002
5" Reflector Trim
Lamp: R30/PAR30 LED E26 18W Max.

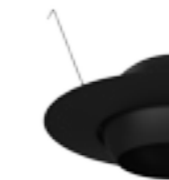

B5003
5" Eyeball Trim
Lamp: R30/PAR30 LED E26 18W Max.



B5003L
5" Large Eyeball Trim
Lamp: R30/PAR30 LED E26 18W Max.



B5007
5" Gimbal Ring Trim
Lamp: R30/PAR30 LED E26 18W Max.



B5011
5" Cone Baffle Trim
Lamp: A19 LED E26 12W Max.



B5011K
5" Baffle Trim
Lamp: R30/PAR30 LED E26 18W Max.



B5021
5" Clear Reflector Trim with Baffle
Lamp: A19 LED E26 12W Max.



B5022
5" Cone Reflector Trim
Lamp: A19 LED E26 12W Max.



B5300
5" Shower Trim with Fresnel Lens
Lamp: A19 LED E26 12W Max.
Gasket used to prevent moisture
Wet location listed



B5400
5" Shower Trim with Albalite lens
Lamp: A19 LED E26 12W Max.
Gasket used to prevent moisture
Wet location listed



B5602
5" Shower Trim with Dome Lens
Lamp: A19 LED E26 12W Max.
Gasket used to prevent moisture
Wet location listed



B5800
5" Shower Trim with Frosted Lens
Lamp: A19 LED E26 12W Max.
Gasket used to prevent moisture
Wet location listed



B5500
5" Shower Trim with Drop Opal
Lamp: A19 LED E26 12W Max.
Gasket used to prevent moisture
Wet location listed



B5700
5" Shower Trim with Centre Frosted
Lens
Lamp: A19 LED E26 12W Max.
Gasket used to prevent moisture
Wet location listed

ORDERING GUIDE ✓
YOUR PRODUCT CODE

SERIES

B5 _____
5 Inch Trim

RING FINISH

- White Matte
- White Shining
- Black Matte
- Black Shining
- Oil Rubbed Brown
- Grey
- Satin Nickel
- Chrome
- Polished Brass
- Mocha
- Golden

BAFFLE/REFLECTOR FINISH

- Clear
- Haze
- Champagne
- White Matte
- White Shining
- Black Matte
- Black Shining
- Oil Rubbed Brown
- Grey
- Satin Nickel
- Chrome
- Polished Brass
- Mocha
- Golden

* Customized Also Available

A6
**6" NEW CONSTRUCTION
NON-IC RECESSED
HOUSING**

DESCRIPTION
Housing must be kept at least 3" away from insulation
Can be installed in 1/2" to 1-3/8" thick ceilings
Includes adjustable hanger bars with integral nail
J-Box listed for through-branch circuit wiring (4 in-4 out), five 1/2" knockouts
and four romex knockouts with strain clamps
ETL listed for damp location W/Feed through

Lamp: LED 24W max. (See trim for max wattage)

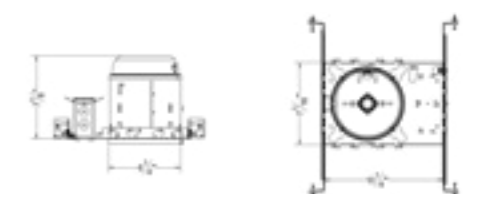

A6-R
**6" REMODEL NON-IC
RECESSED HOUSING**

DESCRIPTION
Housing must be kept at least 3" away from insulation
Can be installed in 1/2" to 1-3/8" thick ceilings
J-Box listed for through-branch circuit wiring (4 in-4 out), five 1/2" knockouts
and four romex knockouts with strain clamps
ETL listed for damp location W/Feed through

Lamp: LED 24W max. (See trim for max wattage)

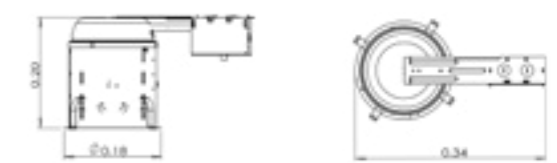

A6-IA
**6" NEW CONSTRUCTION
AIRTIGHT IC RATED
RECESSED HOUSING**

DESCRIPTION
Designed for direct contact with insulation
Can be installed in 1/2" to 1-3/8" thick ceilings
Includes adjustable hanger bars with integral nail
J-Box listed for through-branch circuit wiring (4 in-4 out), five 1/2" knockouts
and four romex knockouts with strain clamps
ETL listed for damp location W/Feed through

Lamp: LED 24W max. (See trim for max wattage)

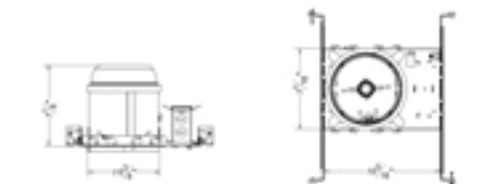

A6-RIA

6" REMODEL AIRTIGHT IC RATED RECESSED HOUSING

DESCRIPTION

Designed for direct contact with insulation
 Can be installed in 1/2" to 1-3/8" thick ceilings
 J-Box listed for through-branch circuit wiring (4 in-4 out), five 1/2" knockouts
 and four romex knockouts with strain clamps
 ETL listed for damp location W/Feed through



Lamp: LED 24W max. (See trim for max wattage)



A6-SIA

6" NEW CONSTRUCTION AIRTIGHT IC RATED SHALLOW RECESSED HOUSING

DESCRIPTION

Housing must be kept at least 3" away from insulation
 Can be installed in 1/2" to 1-3/8" thick ceilings
 Includes adjustable hanger bars with integral nail
 J-Box listed for through-branch circuit wiring (4 in-4 out), five 1/2" knockouts
 and four romex knockouts with strain clamps
 ETL listed for damp location W/Feed through

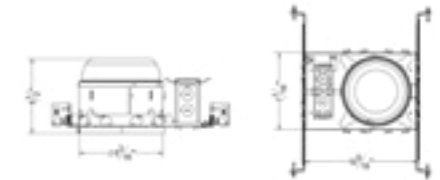
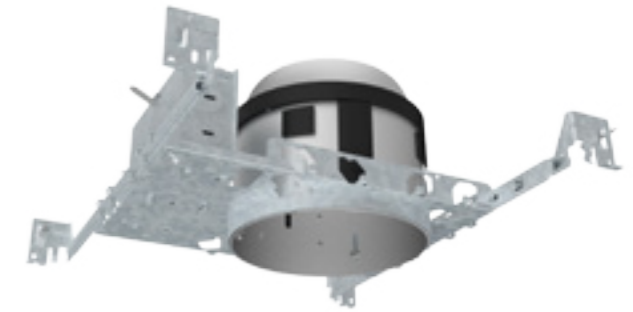

Lamp: LED 24W max. (See trim for max wattage)



A6-S

6" NEW CONSTRUCTION NON-IC SHALLOW RECESSED HOUSING

DESCRIPTION

Housing must be kept at least 3" away from insulation
 Can be installed in 1/2" to 1-3/8" thick ceilings
 Includes adjustable hanger bars with integral nail
 J-Box listed for through-branch circuit wiring (4 in-4 out), five 1/2" knockouts
 and four romex knockouts with strain clamps
 ETL listed for damp location W/Feed through

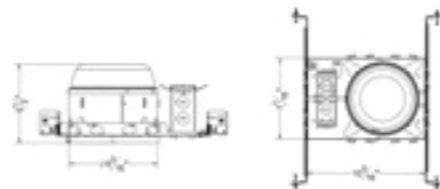

Lamp: LED 24W max. (See trim for max wattage)



A6-SRIA

6" REMODEL IC RATED SHALLOW RECESSED HOUSING

DESCRIPTION

Housing must be kept at least 3" away from insulation
 Can be installed in 1/2" to 1-3/8" thick ceilings
 J-Box listed for through-branch circuit wiring (4 in-4 out), five 1/2" knockouts
 and four romex knockouts with strain clamps
 ETL listed for damp location W/Feed through

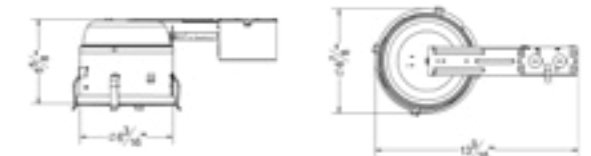

Lamp: LED 24W max. (See trim for max wattage)



A6-SR

6" REMODEL NON-IC SHALLOW RECESSED HOUSING

DESCRIPTION

Housing must be kept at least 3" away from insulation
 Can be installed in 1/2" to 1-3/8" thick ceilings
 J-Box listed for through-branch circuit wiring (4 in-4 out), five 1/2" knockouts
 and four romex knockouts with strain clamps
 ETL listed for damp location W/Feed through



Lamp: LED 24W max. (See trim for max wattage)



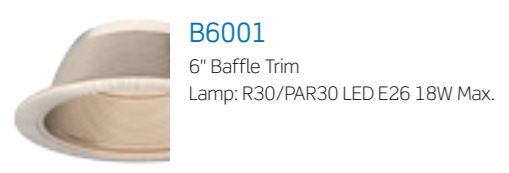

B6001
6" Baffle Trim
Lamp: R30/PAR30 LED E26 18W Max.



B6002
6" Reflector Trim
Lamp: R30/PAR30 LED E26 18W Max.



B6003
6" Eyeball Trim
Lamp: R30/PAR30 LED E26 18W Max.



B6007
6" Gimbal Ring Trim
Lamp: R30/PAR30 LED E26 18W Max.



B6011
6" Cone Baffle Trim
Lamp: A19 LED E26 12W Max.



B6012W
6" Full Reflector Trim
Lamp: A19 LED E26 12W Max.



B6016
6" Wall Wash Baffle Trim
Lamp: R30/PAR30 LED E26 18W Max.



B6001L
6" Baffle Trim
Lamp: R40/PAR38 LED E26 24W Max.



B6002L
6" Reflector Trim
Lamp: R40/PAR38 LED E26 24W Max.

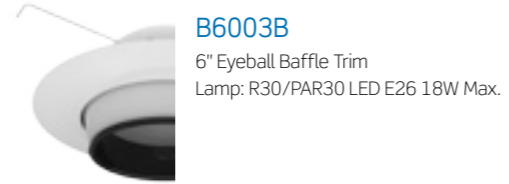

B6003B
6" Eyeball Baffle Trim
Lamp: R30/PAR30 LED E26 18W Max.



B6007L
6" PAR38 Gimbal Ring Trim
Lamp: R40/PAR38 LED E26 24W Max.



B6012
6" Reflector and Baffle Trim
Lamp: A19 LED E26 12W Max.



B6013
6" Eyeball and Baffle Trim
Lamp: R30/PAR30 LED E26 18W Max.



B6017
6" Gimbal Ring Trim with Baffle
Lamp: R30/PAR30 LED E26 18W Max.

ORDERING GUIDE ✓
YOUR PRODUCT CODE

SERIES

B6 _____
6 Inch Trim

RING FINISH

- White Matte
- White Shining
- Black Matte
- Black Shining
- Oil Rubbed Brown
- Grey
- Satin Nickel
- Chrome
- Polished Brass
- Mocha
- Golden

BAFFLE/REFLECTOR FINISH

- Clear
- Haze
- Champagne
- White Matte
- White Shining
- Black Matte
- Black Shining
- Oil Rubbed Brown
- Grey
- Satin Nickel
- Chrome
- Polished Brass
- Mocha
- Golden

* Customized Also Available

ORDERING GUIDE ✓
YOUR PRODUCT CODE

SERIES

B6 _____
6 Inch Trim

RING FINISH

- White Matte
- White Shining
- Black Matte
- Black Shining
- Oil Rubbed Brown
- Grey
- Satin Nickel
- Chrome
- Polished Brass
- Mocha
- Golden

BAFFLE/REFLECTOR FINISH

- Clear
- Haze
- Champagne
- White Matte
- White Shining
- Black Matte
- Black Shining
- Oil Rubbed Brown
- Grey
- Satin Nickel
- Chrome
- Polished Brass
- Mocha
- Golden

* Customized Also Available



B6017L
6" Adjustable Gimbal Trim with Baffle
Lamp: R40/PAR38 LED E26 24W Max.



B6021L
6" PAR38 Baffle Trim
Lamp: R40/PAR38 LED E26 24W Max.



B6026
6" Wall Wash Reflector Trim
Lamp: R30/PAR30 LED E26 18W Max.



B6400
6" Shower Trim with Albalite Lens
Lamp: A19 LED E26 12W Max.
Gasket used to prevent moisture
Wet location listed



B6700
6" Shower Trim with Centre Frosted Lens
Lamp: A19 LED E26 12W Max.
Gasket used to prevent moisture
Wet location listed



B6021
6" PAR30 Baffle Trim
Lamp: R30/PAR30 LED E26 18W Max.

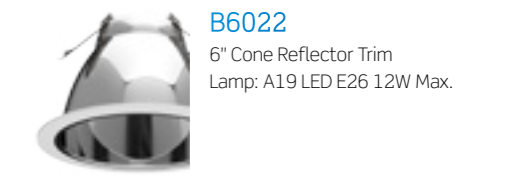

B6022
6" Cone Reflector Trim
Lamp: A19 LED E26 12W Max.



B6300
6" Shower Trim with Fresnel Lens
Lamp: A19 LED E26 12W Max.
Gasket used to prevent moisture
Wet location listed

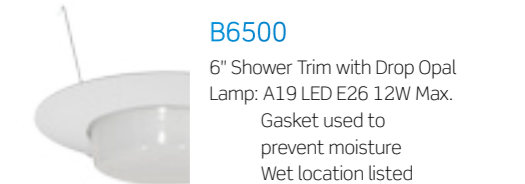

B6500
6" Shower Trim with Drop Opal
Lamp: A19 LED E26 12W Max.
Gasket used to prevent moisture
Wet location listed



B6800
6" Shower with Frosted Lens
Lamp: A19 LED E26 12W Max.
Gasket used to prevent moisture
Wet location listed

A6-P

6" LINE VOLTAGE NEW CONSTRUCTION NON-IC SLOPE RECESSED HOUSING

DESCRIPTION

Housing must be kept at least 3" away from insulation
 Can be installed in 1/2" to 1-3/8" thick ceilings
 Includes adjustable hanger bars with integral nail
 J-Box listed for through-branch circuit wiring (4 in-4 out), five 1/2" knockouts and four romex knockouts with strain clamps
 ETL listed for damp location W/Feed through

Lamp: LED 18W max. (See trim for max wattage)

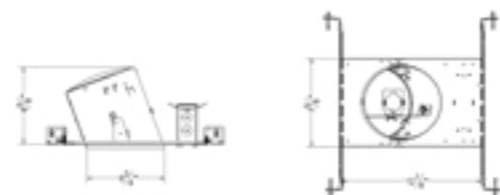

A6-PRIA

6" LINE VOLTAGE REMODEL AIRTIGHT IC RATED SLOPE RECESSED HOUSING

DESCRIPTION

Designed for direct contact with insulation
 Can be installed in 1/2" to 1-3/8" thick ceilings
 J-Box listed for through-branch circuit wiring (4 in-4 out), five 1/2" knockouts and four romex knockouts with strain clamps
 ETL listed for damp location W/Feed through

Lamp: LED 18W max. (See trim for max wattage)



A6-PR

6" LINE VOLTAGE REMODEL NON-IC SLOPE RECESSED HOUSING

DESCRIPTION

Housing must be kept at least 3" away from insulation
 Can be installed in 1/2" to 1-3/8" thick ceilings
 J-Box listed for through-branch circuit wiring (4 in-4 out), five 1/2" knockouts and four romex knockouts with strain clamps
 ETL listed for damp location W/Feed through

Lamp: LED 18W max. (See trim for max wattage)



A6-PIA

6" LINE VOLTAGE NEW CONSTRUCTION AIRTIGHT IC RATED SLOPE RECESSED HOUSING

DESCRIPTION

Designed for direct contact with insulation
 Can be installed in 1/2" to 1-3/8" thick ceilings
 Includes adjustable hanger bars with integral nail
 J-Box listed for through-branch circuit wiring (4 in-4 out), five 1/2" knockouts and four romex knockouts with strain clamps
 ETL listed for damp location W/Feed through

Lamp: LED 18W max. (See trim for max wattage)

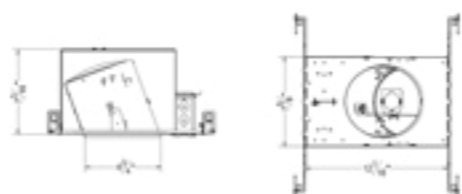

ORDERING GUIDE

YOUR PRODUCT CODE

SERIES

- BP6_____
- 6 Inch Slope Trim

BAFFLE/REFLECTOR FINISH

- Clear
- Haze
- Champagne
- White Matte
- White Shining
- Black Matte
- Black Shining
- Oil Rubbed Brown
- Grey
- Satin Nickel
- Chrome
- Polished Brass
- Mocha
- Golden

* Customized Also Available



BP6001
 6" Slope Trim With Baffle
 Lamp: R30/PAR30
 LED E26 18W Max.



BP6002
 6" Slope Trim With Reflector
 Lamp: R30/PAR30
 LED E26 18W Max.



LED CEILING LIGHT

Ceiling lights are central to overall illumination of a room and set the tone for distinguishing style. Liteharbor according to your house design. You are sure to find a ceiling light to distinguish your lifestyle here at Shades of Light!

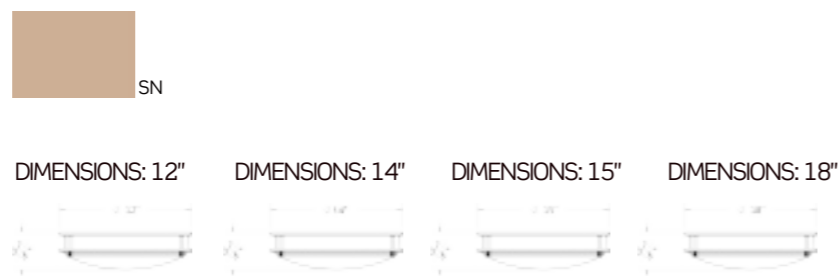

ITEM NO.	MOUNTING	INPUT VOLT.	SIZE	LAMP&WATTAGE	MATERIAL	FINISH
FM-L120	Flush Mount	120V 50/60Hz	12"	SMD 2835 15W	Acrylic	Satin Nickel Other colors consult our factory.
FM-L140			14"	SMD 2835 23W		
FM-L150			15"	SMD 2835 23W		
FM-L180			18"	SMD 2835 30W		

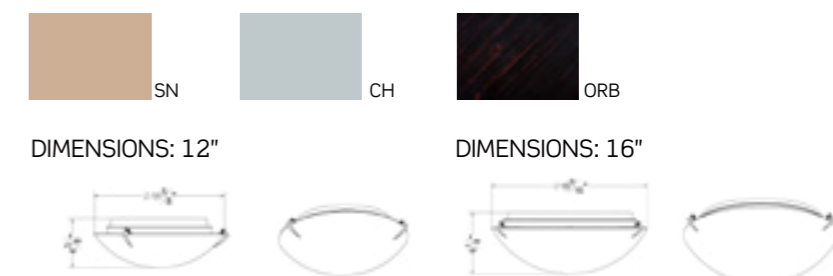

ITEM NO.	MOUNTING	INPUT VOLT.	SIZE	LAMP&WATTAGE	GLASS	FINISH
FM-C122	Flush Mount	110V-220V	12"	2 lights G9 base 2x4W LED	Alabaster Linen Opal Frosted	Satin Nickel Chrome Oil Rubbed Brown Other colors consult our factory.
FM-C163				16"		
	Epistar SMD 2835 18W					
				3 lights G9 base 3x4W LED		
				3 lights E26 base 3x10W LED		
				Epistar SMD 2835 24W		

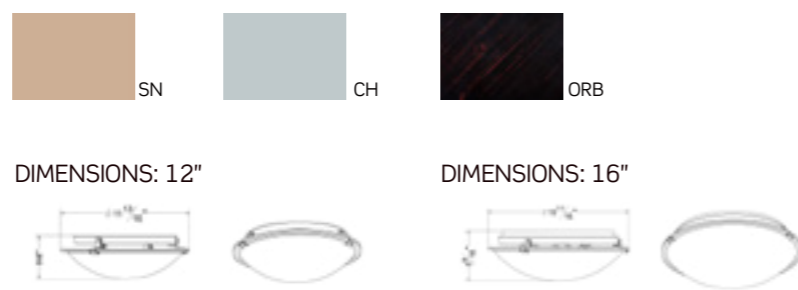

ITEM NO.	MOUNTING	INPUT VOLT.	SIZE	LAMP&WATTAGE	GLASS	FINISH	
FM-A122	Flush Mount	110V-220V	12"	2 lights G9 base 2x4W LED	Alabaster Linen Opal Frosted	Satin Nickel Chrome Oil Rubbed Brown Other colors consult our factory.	
FM-A163				16"			2 lights E26 base 2x10W LED
							Epistar SMD 2835 18W
				3 lights G9 base 3x4W LED			
				3 lights E26 base 3x10W LED			
				Epistar SMD 2835 24W			

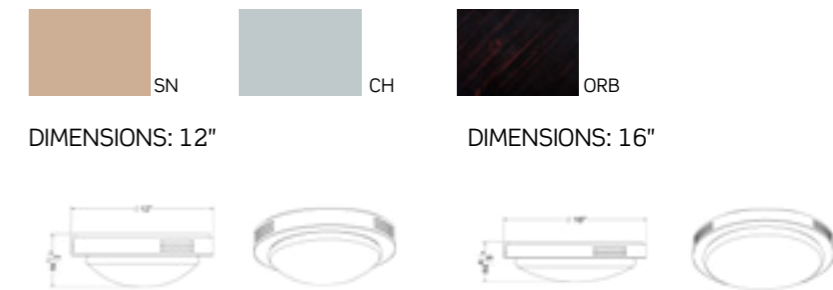

ITEM NO.	MOUNTING	INPUT VOLT.	SIZE	LAMP&WATTAGE	GLASS	FINISH	
FM-D122	Flush Mount	110V-220V	12"	2 lights G9 base 2x4W LED	Alabaster Linen Opal Frosted	Chrome Satin Nickel Oil Rubbed Brown Other colors consult our factory.	
FM-D163				16"			2 lights E26 base 2x10W LED
							Epistar SMD 2835 18W
				3 lights G9 base 3x4W LED			
				3 lights E26 base 3x10W LED			
				Epistar SMD 2835 24W			

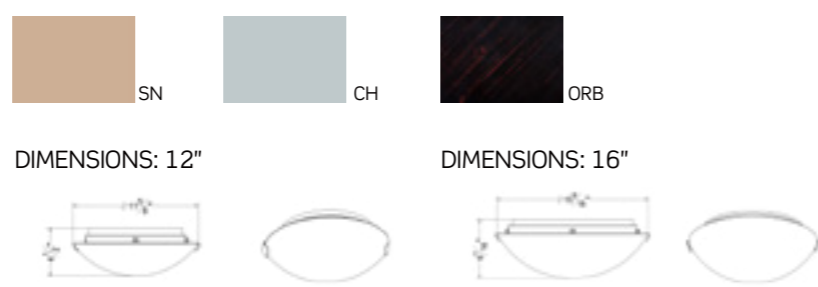

ITEM NO.	MOUNTING	INPUT VOLT.	SIZE	LAMP&WATTAGE	GLASS	FINISH	
FM-B122	Flush Mount	110V-220V	12"	2 lights G9 base 2x4W LED	Alabaster Linen Opal Frosted	Satin Nickel Chrome Oil Rubbed Brown Other colors consult our factory.	
FM-B163				16"			2 lights E26 base 2x10W LED
							Epistar SMD 2835 18W
				3 lights G9 base 3x4W LED			
				3 lights E26 base 3x10W LED			
				Epistar SMD 2835 24W			

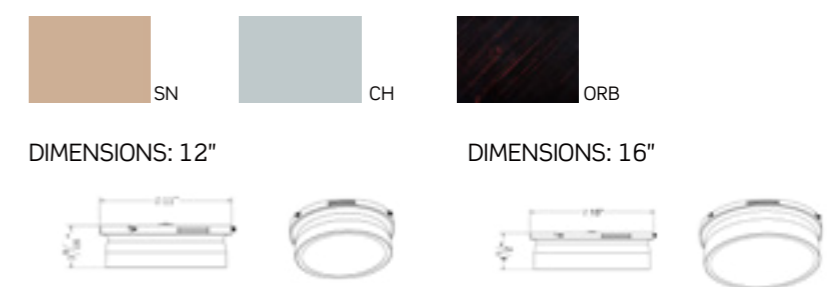

ITEM NO.	MOUNTING	INPUT VOLT.	SIZE	LAMP&WATTAGE	GLASS	FINISH	
FM-E122	Flush Mount	110V-220V	12"	2 lights G9 base 2x4W LED		Chrome Satin Nickel Oil Rubbed Brown Other colors consult our factory.	
FM-E163				16"			2 lights E26 base 2x10W LED
							Epistar SMD 2835 18W
				3 lights G9 base 3x4W LED			
				3 lights E26 base 3x10W LED			
				Epistar SMD 2835 24W			



DIMENSIONS: 12"

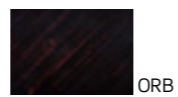

DIMENSIONS: 16"



ITEM NO.	MOUNTING	INPUT VOLT.	SIZE	LAMP&WATTAGE	GLASS	FINISH
FM-F122	Flush Mount	110V-220V	12"	2 lights G9 base 2x4W LED	Alabaster Linen Opal Frosted	Chrome Satin Nickel Oil Rubbed Brown Other colors consult our factory.
FM-F163				2 lights E26 base 2x10W LED		
				Epistar SMD 2835 18W		
			16"	3 lights G9 base 3x4W LED		
				3 lights E26 base 3x10W LED		
				Epistar SMD 2835 24W		



DIMENSIONS: 6"



DIMENSIONS: 10"

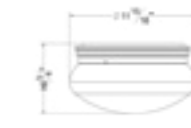

ITEM NO.	MOUNTING	INPUT VOLT.	SIZE	LAMP&WATTAGE	GLASS	FINISH
MU-6	Flush Mount	110V-220V	6"	1 light G9 base 1x4W LED	Alabaster Linen Opal Frosted	White Chrome Satin Nickel Oil Rubbed Brown Other colors consult our factory.
MU-10				1 light E26 base 1x10W LED		
				Epistar SMD 2835 18W		
			10"	2 lights G9 base 2x4W LED		
				2 lights E26 base 2x10W LED		
				Epistar SMD 2835 24W		



DIMENSIONS: 12"

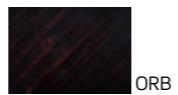

DIMENSIONS: 16"



ITEM NO.	MOUNTING	INPUT VOLT.	SIZE	LAMP&WATTAGE	GLASS	FINISH
FM-G122	Flush Mount	110V-220V	12"	2 lights G9 base 2x4W LED	Alabaster Linen Opal Frosted	Chrome Satin Nickel Oil Rubbed Brown Other colors consult our factory.
FM-G163				2 lights E26 base 2x10W LED		
				Epistar SMD 2835 18W		
			16"	3 lights G9 base 3x4W LED		
				3 lights E26 base 3x10W LED		
				Epistar SMD 2835 24W		



DIMENSIONS: 12"



DIMENSIONS: 16"



ITEM NO.	MOUNTING	INPUT VOLT.	SIZE	LAMP&WATTAGE	GLASS	FINISH
FM-S122	Flush Mount	110V-220V	12"	2 lights G9 base 2x4W LED	Alabaster Linen Opal Frosted	Chrome Satin Nickel Oil Rubbed Brown Other colors consult our factory.
FM-S163				2 lights E26 base 2x10W LED		
				Epistar SMD 2835 18W		
			16"	3 lights G9 base 3x4W LED		
				3 lights E26 base 3x10W LED		
				Epistar SMD 2835 24W		



DIMENSIONS: 12"

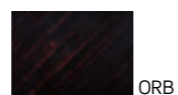

DIMENSIONS: 16"



ITEM NO.	MOUNTING	INPUT VOLT.	SIZE	LAMP&WATTAGE	GLASS	FINISH
FM-H122	Flush Mount	110V-220V	12"	2 lights G9 base 2x4W LED	Alabaster Linen Opal Frosted	Chrome Satin Nickel Oil Rubbed Brown Other colors consult our factory.
FM-H163				2 lights E26 base 2x10W LED		
				Epistar SMD 2835 18W		
			16"	3 lights G9 base 3x4W LED		
				3 lights E26 base 3x10W LED		
				Epistar SMD 2835 24W		



Dimensions: **12"**

LED WALL SCONCE

Liteharbor Wall Sconces show a modern and elegant appearance. Wall sconces can apply to living room, bedroom, corridor and bathroom, truly versatile and graceful. Alabaster, opal, diamond and other glass cover for choices, special grain appear modern design.



DIMENSIONS:



ITEM NO.	MOUNTING	INPUT VOLT.	SIZE	LAMP&WATTAGE	GLASS	FINISH
WS-A122	Flush Mount	110V-220V	12"	1 light G9 base 1x4W LED	Alabaster Linen Opal Frosted	Satin Nickel Chrome Oil Rubbed Brown Other colors consult our factory.
				1 light E26 base 1x10W LED		



DIMENSIONS:

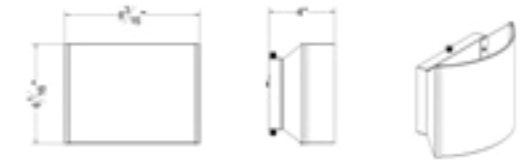

ITEM NO.	MOUNTING	INPUT VOLT.	LAMP	WATTAGE	GLASS	FINISH
WS-11AL	Flush Mount	110V-130V 220V-240V	J78	1x6W LED	Diamond Alabaster Linen Opal Frosted	Satin Nickel Chrome Oil Rubbed Brown Other colors consult our factory.



DIMENSIONS:

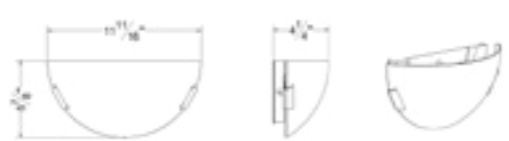

ITEM NO.	MOUNTING	INPUT VOLT.	SIZE	LAMP&WATTAGE	GLASS	FINISH
WS-B122	Flush Mount	110V-220V	12"	1 light G9 base 1x4W LED	Alabaster Linen Opal Frosted	Satin Nickel Chrome Oil Rubbed Brown Other colors consult our factory.
				1 light E26 base 1x10W LED		

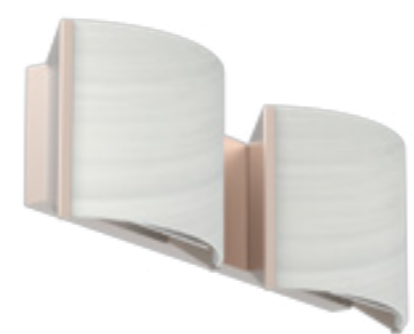

DIMENSIONS:



ITEM NO.	MOUNTING	INPUT VOLT.	LAMP	WATTAGE	GLASS	FINISH
WS-12AL	Flush Mount	110V-130V 220V-240V	J78	2x6W LED	Diamond Alabaster Linen Opal Frosted	Satin Nickel Chrome Oil Rubbed Brown Other colors consult our factory.



DIMENSIONS:

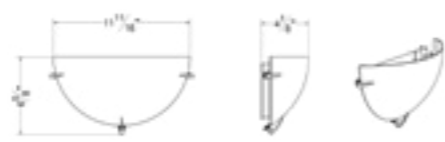

ITEM NO.	MOUNTING	INPUT VOLT.	SIZE	LAMP&WATTAGE	GLASS	FINISH
WS-C122	Flush Mount	110V-220V	12"	1 light G9 base 1x4W LED	Alabaster Linen Opal Frosted	Satin Nickel Chrome Oil Rubbed Brown Other colors consult our factory.
				1 light E26 base 1x10W LED		



DIMENSIONS:



ITEM NO.	MOUNTING	INPUT VOLT.	LAMP	WATTAGE	GLASS	FINISH
WS-13AL	Flush Mount	110V-130V 220V-240V	J78	3x6W LED	Diamond Alabaster Linen Opal Frosted	Satin Nickel Chrome Oil Rubbed Brown Other colors consult our factory.



LED CABINET LIGHT

Liteharbor cabinet lights are extremely versatile, task light and accent kit both available in incandescent, compact fluorescent and LED lamp.

LED UNDER CABINET TASK LIGHT

LIGHT SOURCE SMD CHIPS **UCL0903**



DESCRIPTION

This unit is capable of being converted as a fixed hard wire unit when used with supplied parts bag
Suitable for under cabinet mount
1" thin
Opal glass diffuser
Linkable to 20pcs max
On-off switch
Lock out for hard wiring
Hard wire or plug in
25000 hours life time
Body coating body white, black, silver are available
Dry location only

ACCESSORIES INCLUDED

Linking wire
Plug in cord
Hard wire connection

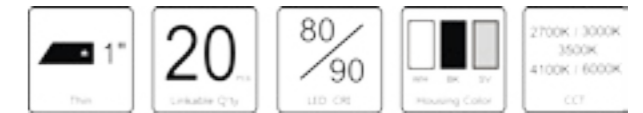

9" 12" 18" 24"

DIMENSION



L: 9"xW: 4-1/16"xH: 1-7/16"
▶ DGL-UCL0903

L: 12"xW: 4-1/16"xH: 1-7/16"
▶ DGL-UCL1206

L: 18"xW: 4-1/16"xH: 1-7/16"
▶ DGL-UCL1809

L: 24"xW: 4-1/16"xH: 1-7/16"
▶ DGL-UCL2412

ORDERING GUIDE / YOUR PRODUCT CODE

SERIES	WATTS	INPUT VOLT	CCT	HOUSING COLOR
○ UCL0903 LED Under Cabinet Task Light/9"	- 3W Equals 25W Halogen	○ 120V	○ 2700K	○ White
○ UCL1206 LED Under Cabinet Task Light/12"	- 6W Equals 50W Halogen	○ 277V	○ 3000K	○ Black
○ UCL1809 LED Under Cabinet Task Light/18"	- 9W Equals 75W Halogen		○ 3500K	○ Silver
○ UCL2412 LED Under Cabinet Task Light/24"	- 12W Equals 100W Halogen		○ 4100K	
			○ 6000K	

* Customized Also Available

LISTING / WARRANTY

ETL listed to US and Canadian standards for damp location W/Feed through.
3 Years Limited Warranty.



LED UNDER CABINET TASK LIGHT

LIGHT SOURCE
LED T5 **UC1250**



DESCRIPTION

Made of die-formed rolled steel
PC cover no UV no glare
Three primary colors good for eyes
Fixture is pre-wire for immediate hard wire connection to 120V power source
Integral class-P, 120V normal factor ballast for efficient operation
Powder coating is high temperature resistance

LAMP

1xT5 8/13/13+8/13+13W
Color temperature does at customers' requirements

Mounting

Two mountings crews provided for installation into wood surface two key hole slots located in the back of the fixture housing

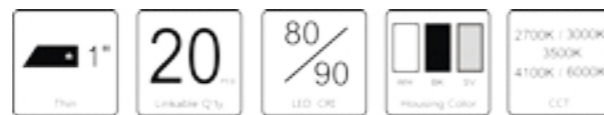

12"

21"

33"

42"

DIMENSION



L: 12"xW: 5"xH: 1"

▶ UC1250

L: 21"xW: 5"xH: 1"

▶ UC2150

L: 33"xW: 5"xH: 1"

▶ UC3350

L: 42"xW: 5"xH: 1"

▶ UC4250

ORDERING GUIDE / YOUR PRODUCT CODE

SERIES	- Watts	INPUT VOLT	CCT	HOUSING COLOR
○ U1250 T5 LED Under Cabinet Light/12"	- 8W	○ 120V	○ 2700K	○ White
○ U2150 T5 LED Under Cabinet Light/21"	- 13W	○ 277V	○ 3000K	○ Black
○ U3350 T5 LED Under Cabinet Light/33"	- 13+8W		○ 3500K	○ Silver
○ U4250 T5 LED Under Cabinet Light/42"	- 13+13W		○ 4100K	
			○ 6000K	

* Customized Also Available

LISTING / WARRANTY

ETL listed to US and Canadian standards for damp location W/Feed through.
3 Years Limited Warranty.



LED UNDER CABINET LIGHT

LIGHT SOURCE
LED G9 **U7014**



DESCRIPTION

Made of die-formed rolled steel
PC cover no UV no glare
Fixture is pre-wire for immediate hard wire connection to 120V power source
Powder coating is high temperature resistance
102 switch for controlling lighting
Clear glass cover
Electronic transformer

LAMP

12V G4 20W each lamp

HOUSING COLOR

White/ Black/ Silver

MOUNTING

Surface mounting and hanging mounting are both available



14"

24"

34"

DIMENSION



L: 14"xW: 2"xH: 1"

▶ U7014

L: 24"xW: 2"xH: 1"

▶ U7024

L: 34"xW: 2"xH: 1"

▶ U7034

ORDERING GUIDE / YOUR PRODUCT CODE

SERIES	- Watts	INPUT VOLT	CCT	HOUSING COLOR
○ U7014 G4 LED Under Cabinet Light/14"	- 3W	○ 120V	○ 2700K	○ White
○ U7024 G4 LED Under Cabinet Light/24"	- 6W	○ 277V	○ 3000K	○ Black
○ U7034 G4 LED Under Cabinet Light/34"	- 9W		○ 3500K	○ Silver
			○ 4100K	
			○ 6000K	

* Customized Also Available

LISTING / WARRANTY

ETL listed to US and Canadian standards for damp location W/Feed through.
3 Years Limited Warranty.

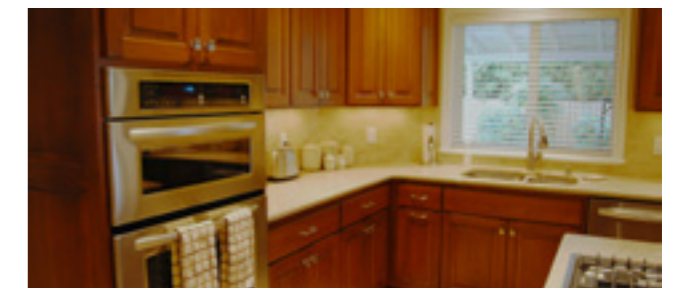

DGL-U7016

LED UNDER CABINET LIGHT



DESCRIPTION

Metal body.
Can be mounted recessed.
Packaged with one LED drive (with wide input 100-240V) with 6 feet power cord and plug.

LAMP

COB LED 1W x 3
150LM
3000K

LISTING / WARRANTY

ETL listed to US and Canadian standards for damp location W/Feed through.
3 Years Limited Warranty.



ORDERING GUIDE

YOUR PRODUCT CODE ✓

SERIES	INPUT VOLTAGE	FINISH
<input type="radio"/> DGL-U7016 LED Under Cabinet Light	<input type="radio"/> DC 12V	<input type="radio"/> White <input type="radio"/> Black <input type="radio"/> Satin Nickel <input type="radio"/> Chrome

*Customized Also Available

DGL-U7017

LED UNDER CABINET LIGHT



DESCRIPTION

120V LED Puck lights, 3 LED pucks accent kit
Easy to install, surface or recess mount
Warm white, 1.5W each puck
Linkable dimmable
50% brighter than halogen or xenon pucks
Cool to touch
Energy saving
Long life
Lens cover is UV filter

LISTING / WARRANTY

ETL listed to US and Canadian standards for damp location W/Feed through.
3 Years Limited Warranty.



ORDERING GUIDE

YOUR PRODUCT CODE ✓

SERIES	INPUT VOLTAGE	FINISH
<input type="radio"/> DGL-U7017 LED Under Cabinet Light	<input type="radio"/> 120V <input type="radio"/> 277V	<input type="radio"/> White <input type="radio"/> Black <input type="radio"/> Satin Nickel <input type="radio"/> Chrome

*Customized Also Available

AM9

MR11 MINI ADJUSTABLE DOWN LIGHT



DESCRIPTION

MR11 Mini Adjustable Down Light.
Recessed mounted Housing included.
Clear glass included.
40° adjustment.
Remote 12V transformer required.

LAMP

LED MR11 12V 5W Max.

LISTING / WARRANTY

ETL listed to US and Canadian standards for damp location W/Feed through.
3 Years Limited Warranty.

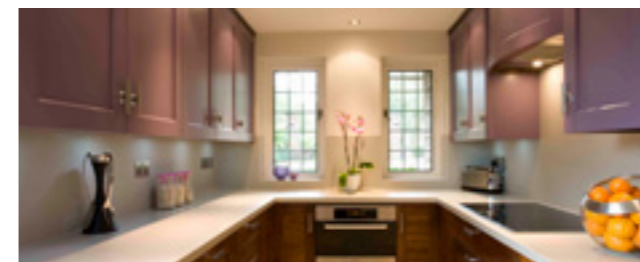

ORDERING GUIDE

YOUR PRODUCT CODE ✓

SERIES	INPUT VOLTAGE	FINISH
<input type="radio"/> AM9 MR11 Mini Adjustable Down Light	<input type="radio"/> 120V <input type="radio"/> 277V	<input type="radio"/> White <input type="radio"/> Black <input type="radio"/> Satin Nickel <input type="radio"/> Mocha

*Customized Also Available

AM12

MR16 MINI ADJUSTABLE DOWN LIGHT



DESCRIPTION

MR16 Mini Adjustable Down Light.
Recessed mounted Housing included.
Clear glass included.
40° adjustment.
Remote 12V transformer required.

LAMP

LED MR16 12V 8W Max.

LISTING / WARRANTY

ETL listed to US and Canadian standards for damp location W/Feed through.
3 Years Limited Warranty.



ORDERING GUIDE

YOUR PRODUCT CODE ✓

SERIES	INPUT VOLTAGE	FINISH
<input type="radio"/> AM12 MR16 Mini Adjustable Down Light	<input type="radio"/> 120V <input type="radio"/> 277V	<input type="radio"/> White <input type="radio"/> Black <input type="radio"/> Satin Nickel <input type="radio"/> Mocha

*Customized Also Available



WHOLE INDUSTRY ORIGINAL
CREATION RIVETING
WELDING TURBINE HEAT
DISSIPATION TECHNOLOGY

WAREHOUSE LIGHTING INDUSTRIAL LIGHT FIXTURES LED HIGH BAY LIGHT

Industrial lights are an important part of any commercial or factory setting. Fortunately, Liteharbor produces a huge selection of industrial LED high bay lights at Warehouse-Lighting. Specifically designed for taller ceilings and larger areas.

RIVETING SUPERCONDUCTING SCALE-TYPE LED HIGH BAY LIGHT

HB-013 LIGHT SOURCE SMD CHIPS



DESCRIPTION

Equipped with 60 pieces of patent cooling type aluminum flake
17116 cm² maximum cooling area of the industry
Top turbine tornado style scales of thermal conductivity
Patent riveting welding technology
Use High-flux Anti-glare OSRAM SMD LED Light Source
98% Highlux-system pest control cover
PFC0.95 wide and steady voltage constant current waterproof power supply

FEATURES

Risk-free 3 year limited warranty
First riveting welding turbine heat dissipation technology
According to the german standard production of 5 year service life
Use top 1 high-flux anti-glare distribution led module

LUMINOUS INTENSITY DISTRIBUTION DIAGRAM

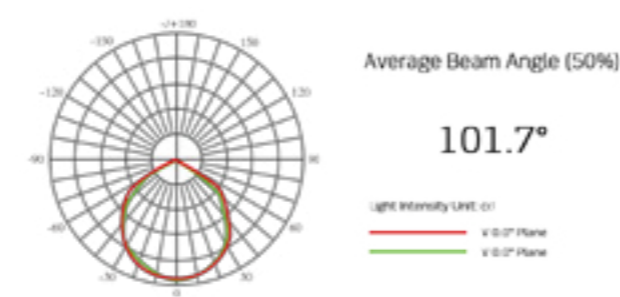

DIMENSIONS

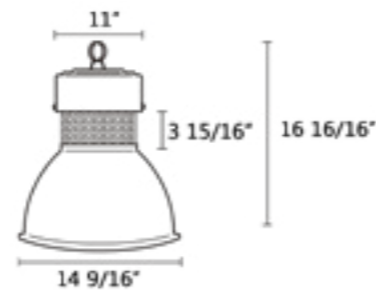

Input Voltage	AC85~265V / 50~60Hz
Chip	Anti-glare SMD LED
Material	Thermal Conductivity Aluminum Alloy Steel
Irradiation Distance	8M~10M
Radiation Area	17116cm ²
Light Distribution Mode	LED+Reflector+ Optical PC cover
IP Rating	Suitable For Damp Locations
Temperature Rise	<55°C
Lifespan of Chip	>50000 hours

ORDERING GUIDE / YOUR PRODUCT CODE

SERIES	WATTS/LUMENS	BEAM ANGLE	CCT
○ HB-013 Module LED High Bay Light	○ 100W/12000LM	○ 90°	○ 4000K
	○ 120W/14400LM	○ 120°	○ 5000K
	○ 150W/18000LM		○ 6000K
	○ 180W/21600LM		○ 7000K
	○ 200W/24000LM		

* Customized Also Available

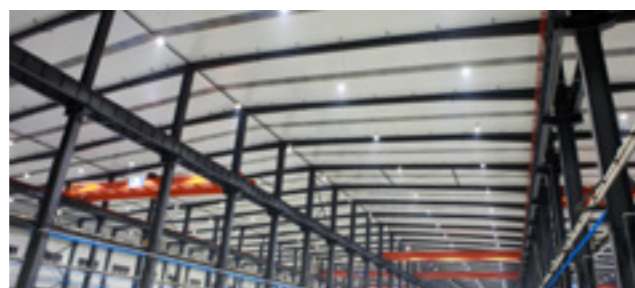

STAMPING ALUMINUM SCALE-TYPE LED HIGH BAY LIGHT

HB-014 LIGHT SOURCE SMD CHIPS



DESCRIPTION

Equipped with 32 pieces of 225 mm high thermal zero distance scales, 2mm super-thick die casting aluminum waterproof back cover function, big size stainless steel waterproof rings and waterproof screw highest transmittance PP corrosion resistance to high temperature seal lens PFC0.95 wide and steady voltage constant current waterproof power supply.

FEATURES

Risk-free 3 year limited Warranty
Lowest Temperature Rise Superconductor Scales module
Use Top Brand High brightness chip

LUMINOUS INTENSITY DISTRIBUTION DIAGRAM

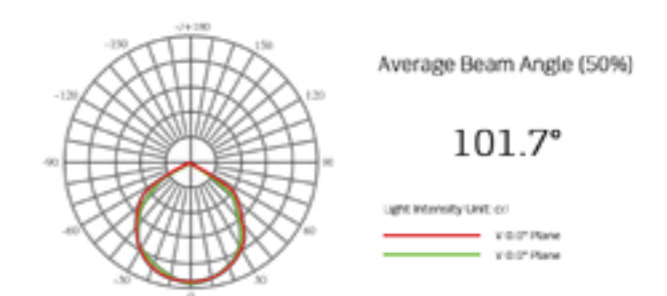

DIMENSIONS

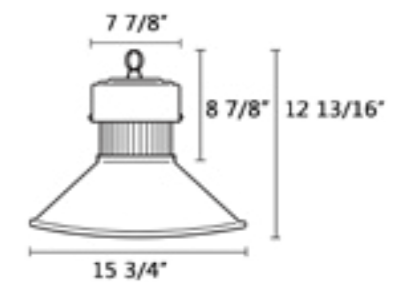

Input Voltage	AC85~265V / 50~60Hz
Chip	Anti-glare SMD LED
Material	High strength aluminum alloy steel
Beam Angle	120°
Power Factor	>65% / >95%
Light Distribution Mode	LED+Optical Lens
IP Rating	Suitable For Damp Locations
Temperature Rise	<65°C
Lifespan of Chip	>50000 hours

ORDERING GUIDE / YOUR PRODUCT CODE

SERIES	WATTS/LUMENS	POWER FACTOR	CCT
○ HB-014 Module LED High Bay Light	○ 50W/5500LM	○ > 65%	○ 2700K
	○ 80W/8800LM	○ > 95%	○ 3000K
	○ 100W/11000LM		○ 4000K
	○ 120W/13200LM		○ 5000K
			○ 6000K
			○ 7000K

* Customized Also Available



MODULE LED HIGH BAY LIGHT

HB-015 LIGHT SOURCE COB LED



DESCRIPTION

28 pieces high density 3mm scale heat radiation module
Large size stainless steel waterproof rings and screws
Wide voltage regulated constant current pouring glue water supply
Solid high light transmission and diffuse reflection optical lens
Overall use of drip proof seal design

FEATURES

Verified by more than 1000 factories
German production standard of 5 years of service life
Under the same quality service, the product price is leading the whole industry

LUMINOUS INTENSITY DISTRIBUTION DIAGRAM

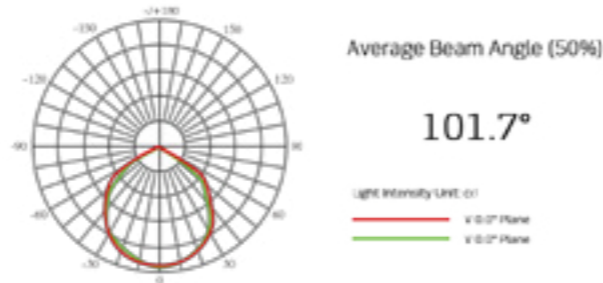

DIMENSIONS

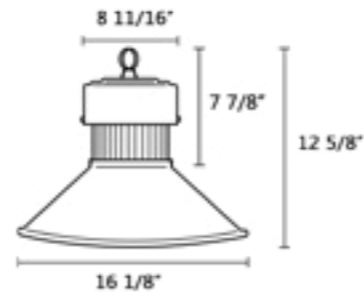

Input Voltage	AC85~265V / 50~60Hz
Power Factor	>65% / >95%
Material	High strength aluminum alloy
Beam Angle	60° 90° 120°
Distance Area	2M~5M / 20M²~36M²
Light Distribution Mode	LED+Reflector Optical Lens
IP Rating	Suitable For Damp Locations
Temperature Rise	<65°C
Lifespan of Chip	>50000 hours

ORDERING GUIDE / YOUR PRODUCT CODE

SERIES	WATTS/LUMENS	POWER FACTOR	CCT	BEAM ANGLE
○ HB-015 Module LED High Bay Light	○ 30W/3300LM	○ >65%	○ Cool white	○ 60°
	○ 50W/5500LM	○ >95%	○ Pure white	○ 90°
	○ 80W/8800LM		○ Warm white	○ 120°
	○ 100W/11000LM			
	○ 120W/13200LM			

* Customized Also Available



WHIRLWIND SCALE-TYPE LED HIGH BAY LIGHT

HB-016 LIGHT SOURCE SMD CHIPS



DESCRIPTION

48 pieces top five-star 1060 patent cooling type aluminium alloy flake
21500cm² Maximum cooling area of the industry
Top Turbine tornado style Scales of thermal conductivity
Patent Riveting Welding technology
Use High-flux Anti-glare OSRAM SMD LED Light Source
98% HighLux=System Pest control conver
PFC0.95 wide and steady voltage constant current waterproof power supply

FEATURES

Enjoy zero risk full service of 3-year limited warranty
Whole industry original creation riveting welding turbine heat dissipation technology
According to the German standard production of 3-5-year service life
Use Top 1 high-flux Anti-Glare distribution LED Module

LUMINOUS INTENSITY DISTRIBUTION DIAGRAM

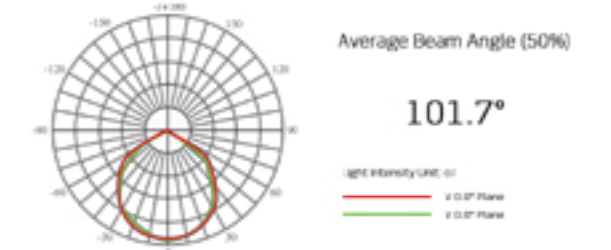

DIMENSIONS



Input Voltage	AC85~265V / 50~60Hz
Chip	Anti-glare SMD LED
Material	Thermal Conductivity Aluminum Alloy Steel
Power Factor	>95%
Beam Angle	90° / 120°
Light Distribution Mode	LED+Reflector+ Optical PC cover
IP Rating	Suitable For Damp Locations
Temperature Rise	<55°C
Lifespan of Chip	>50000 hours

ORDERING GUIDE / YOUR PRODUCT CODE

SERIES	WATTS/LUMENS	BEAM ANGLE	CCT
○ HB-016 Module LED High Bay Light	○ 80W/9600LM	○ 90° ○ 120°	○ 4000K
	○ 100W/12000LM		○ 5000K
	○ 120W/14400LM		○ 6000K
	○ 150W/18000LM		○ 7000K
	○ 150W/18000LM		
	○ 200W/24000LM		

* Customized Also Available





LED BULB

The best and the brightest at Liteharbor Lighting! Liteharbor provides practical illumination and green lighting. Find LED product, you need to look no further than Liteharbor's superb line of LED lights.

LEDS SPOT LIGHT SERIES



DESCRIPTION

Die-casting aluminum material.
 Unique patented Aluminum heat sinking design.
 Shockproof, moisture proof, anti-distortion.
 LED Chip Seoul/Cree/Epistar/Samsung/NXP/Bridgelux optional.
 Real Replacement for traditional halogen bulb.
 Lifetime is 20 times longer than incandescent.
 Saves up to 80% energy compared to incandescent.
 Mercury free, lead free and no UV.
 Streamline configuration combining with LED fittings.
 Perfectly and getting high heat dissipation efficiency .
 2 Years Limited Warranty.

UL NUMBER: **E468917**

OPTIONAL BASE



APPLICATION

Office, building, restaurant, hotel, meeting room, showroom, shop window, telephone cabinet and so on.



DGL-MR16-01

DGL-GU10-01

DGL-HR16-01

DGL-PA20-01

DGL-PA30-01

DGL-PA38-01

ORDERING GUIDE / YOUR PRODUCT CODE



ITEM NO.	LED (pcs)	Input	Watt (W)	CCT (K)	Lumen (lm)	Beam Angle	Avg. Life (hours)	CRI	Dimmable
○ DGL-MR16-01	6	12V AC/DC	6	2700-7000	510-530	35°	30000	>80	Yes
○ DGL-GU10-01	6	85-265V AC	6	2700-7000	510-530	35°	30000	>80	Yes
○ DGL-HR16-01	6	85-265V AC	6	2700-7000	510-530	35°	30000	>80	Yes
○ DGL-PA20-01	5	85-265V AC	10	2700-7000	450-630	30°	30000	>80	Yes
○ DGL-PA30-01	8	85-265V AC	16	2700-7000	920-1050	33°	30000	>80	Yes
○ DGL-PA38-01	10	85-265V AC	20	2700-7000	1280-1520	36°	30000	>80	Yes

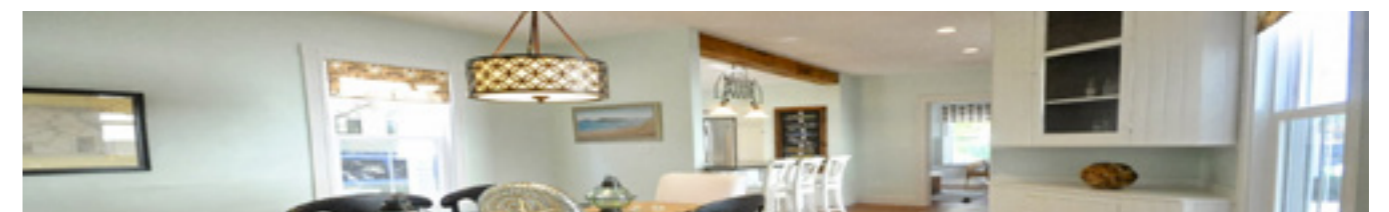

COB SPOT LIGHT SERIES



DESCRIPTION

Die-casting aluminum material.
Aluminum body with high quality powder coating long life and good heat dissipation.
LED Chip Epistar/Cree/Seoul/NXP/Samsung/Bridgelux for option.
Special designed COB LED reflector make the lamp a real spotlight.
The efficiency of the reflector reach 98%.
Tempered glass cover safe to use.
Eco-friendly no mercury, no lead, be recognized as green light of 21st century.
Efficient conversion, reducing heat.
Led lighting converts all energy into light without energy waste.
No fading will do to the documents and clothing.
Constant current quiet and comfortable.
2 Years Limited Warranty.

UL NUMBER: **E468917**

OPTIONAL BASE



MR16 / GU10 / E26

APPLICATION

Suitable for damp locations.
Could be used in recessed cans, ceiling mounted fixtures at home, in shopping malls, hotels, etc.



DGL-MR16-02 DGL-GU10-02 DGL-HR16-02 DGL-PA20-01 DGL-PA30-02 DGL-PA38-02

ORDERING GUIDE / YOUR PRODUCT CODE



ITEM NO.	Input	Watt (W)	CCT (K)	Lumen (lm)	Beam Angle	Avg. Life (hours)	CRI	Dimmable
○ DGL-MR16-02	12V AC/DC	7	2700-7000	510-530	30°	30000	>80	Yes
○ DGL-GU10-02	85-265V AC	7	2700-7000	510-530	30°	30000	>80	Yes
○ DGL-HR16-02	85-265V AC	7	2700-7000	510-530	30°	30000	>80	Yes
○ DGL-PA20-02	85-265V AC	8	2700-7000	530-580	30°	30000	>80	Yes
○ DGL-PA30-02	85-265V AC	14	2700-7000	940-1000	35°	30000	>80	Yes
○ DGL-PA38-02	85-265V AC	22	2700-7000	1300-1400	35°	30000	>80	Yes

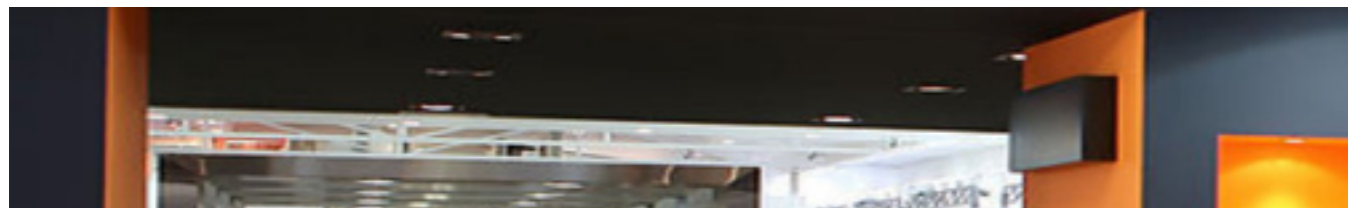

BR LED FLOOD BULB SERIES



DESCRIPTION

Die-casting aluminum material.
Aluminum heat sink good heat dissipation.
No UV or RF interference.
Patented heat sink and optical diffuser.
30000 hours life time.
LED Chip Epistar/Cree/Seoul/NXP/Samsung/Bridgelux for option.
No mercury, no ballast required easy installation.
Wide voltage and constant current design, no noise, no flickering.
Solid state, high shock & vibration resistant.
Mercury free, 66%+ savings in energy consumption.
2 Years Limited Warranty.

UL NUMBER: **E468917**

APPLICATION

Suitable for damp locations.
Could be used in recessed cans, ceiling mounted fixtures at home, in shopping malls, hotels, etc.



DGL-BR40-03 DGL-BR30-03 DGL-BR20-03

ORDERING GUIDE / YOUR PRODUCT CODE



ITEM NO.	Input	Watt (W)	CCT (K)	Lumen (lm)	Beam Angle	Avg. Life (hours)	CRI	Dimmable
○ DGL-BR20-03	85-265V AC	8	2700-7000	480-500	110°	30000	>80	Yes
○ DGL-BR30-03	85-265V AC	12	2700-7000	860-900	110°	30000	>80	Yes
○ DGL-BR40-03	85-265V AC	18	2700-7000	1200-1250	110°	30000	>80	Yes



HALOGEN STYLE PAR LED SERIES



UL NUMBER: **E468917**

DESCRIPTION

Die-casting aluminum material.
 Aluminum body with high quality powder coating long life and good heat dissipation.
 LED Chip Epistar/Cree/Seoul/NXP/Samsung/Bridgelux for option.
 The efficiency of the reflector reach 98%.
 Tempered glass cover safe to use.
 Eco-friendly no mercury, no lead, be recognized as green light of 21st century.
 Efficient conversion, reducing heat .
 Led lighting converts all energy into light without energy waste.
 No fading will do to the documents and clothing.
 Constant current quiet and comfortable.
 2 Years Limited Warranty.

DATA

Input: AC 120V 60Hz
 Base: E26
 Smooth Dimming: 10~100%
 Long Lifespan > 25000 hours
 IP65 wet location in process

APPLICATION

Suitable for damp locations.
 Could be used in recessed cans, ceiling mounted fixtures at home, in shopping malls, hotels, etc.



DGL-PA38-04



DGL-PA30-04-SN



DGL-PA30-04-LN



DGL-PA20-04

ORDERING GUIDE / YOUR PRODUCT CODE



ITEM NO.	Watt (W)	-	CRI	CCT (K)	Lumen (lm)	/	CRI	CCT (K)	Lumen (lm)	-	Beam Angle	Dimmable
○ DGL-PA20-04	7	-	>80	○ 2700/ 3000	500-530	/	>90	○ 2700/ 3000	410-430	-	25°/40°/58°	Yes
				○ 4000/ 5000	550-570			○ 4000/ 5000	450-460			Yes
○ DGL-PA30-04-LN	13	-	>80	○ 2700/ 3000	1000-1050	/	>90	○ 2700/ 3000	800-840	-	27°/40°/58°	Yes
				○ 4000/ 5000	1100-1150			○ 4000/ 5000	880-920			Yes
○ DGL-PA30-04-SN	13	-	>80	○ 2700/ 3000	1000-1050	/	>90	○ 2700/ 3000	800-840	-	27°/40°/58°	Yes
				○ 4000/ 5000	1100-1150			○ 4000/ 5000	880-920			Yes
○ DGL-PA38-04	○ 15	-	>80	○ 2700/ 3000	1160-1200	/	>90	○ 2700/ 3000	950-980	-	15°/27°/40°/58°	Yes
				○ 4000/ 5000	1250-1280			○ 4000/ 5000	1000-1050			Yes
	○ 18	-	>80	○ 2700/ 3000	1320-1400	/	>90	○ 2700/ 3000	1080-1120	-	15°/27°/40°/58°	Yes
				○ 4000/ 5000	1480-1550			○ 4000/ 5000	1200-1280			Yes

